



Veterinary Instruments

VETERINARY Catalogue



TRIPLE HELIX



SOLUTIONS





Orthopedic



Esmarch
 Jo-21-100
 18 cm / 7"



Reiner
 Jo-21-101
 18.5 cm / 7 1/4"

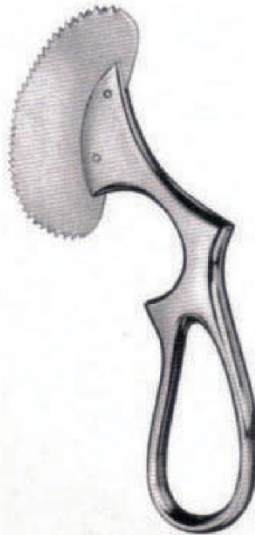

Engel
 Jo-21-104



Jo-21-105	black	Jo-21-108	yellow
Jo-21-106	red	Jo-21-109	orange
Jo-21-107	blue	Jo-21-110	bright pink
14.5 cm / 5 1/2"			

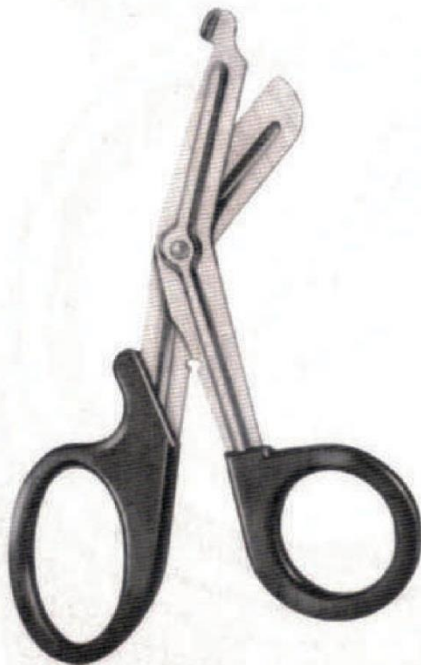

Jo-21-111	black	Jo-21-114	yellow
Jo-21-112	red	Jo-21-115	orange
Jo-21-113	blue	Jo-21-116	bright pink
18 cm / 7"			

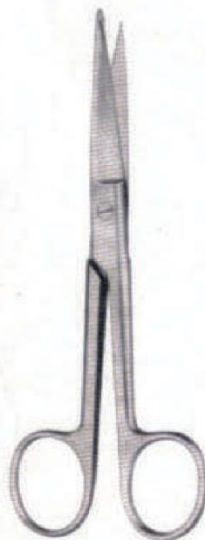

Knowles
 Jo-21-117
 Jo-21-117-A (angled)
 14 cm / 5 1/2"

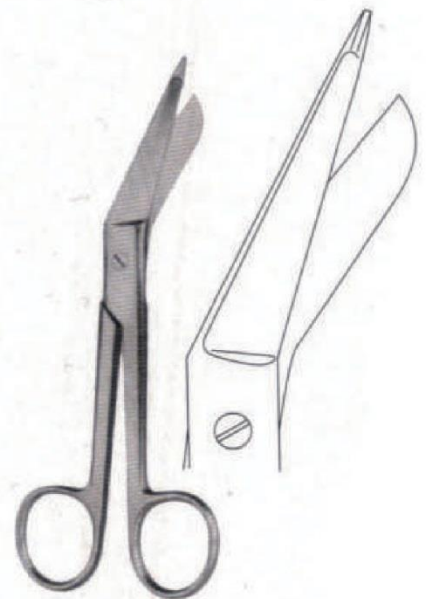

Lister
 Jo-21-118 9 cm / 3 1/2"
 Jo-21-119 11 cm / 4 1/2"
 Jo-21-120 14 cm / 5 1/2"
 Jo-21-121 16 cm / 6 1/4"
 Jo-21-122 18 cm / 7"
 Jo-21-123 20 cm / 8"

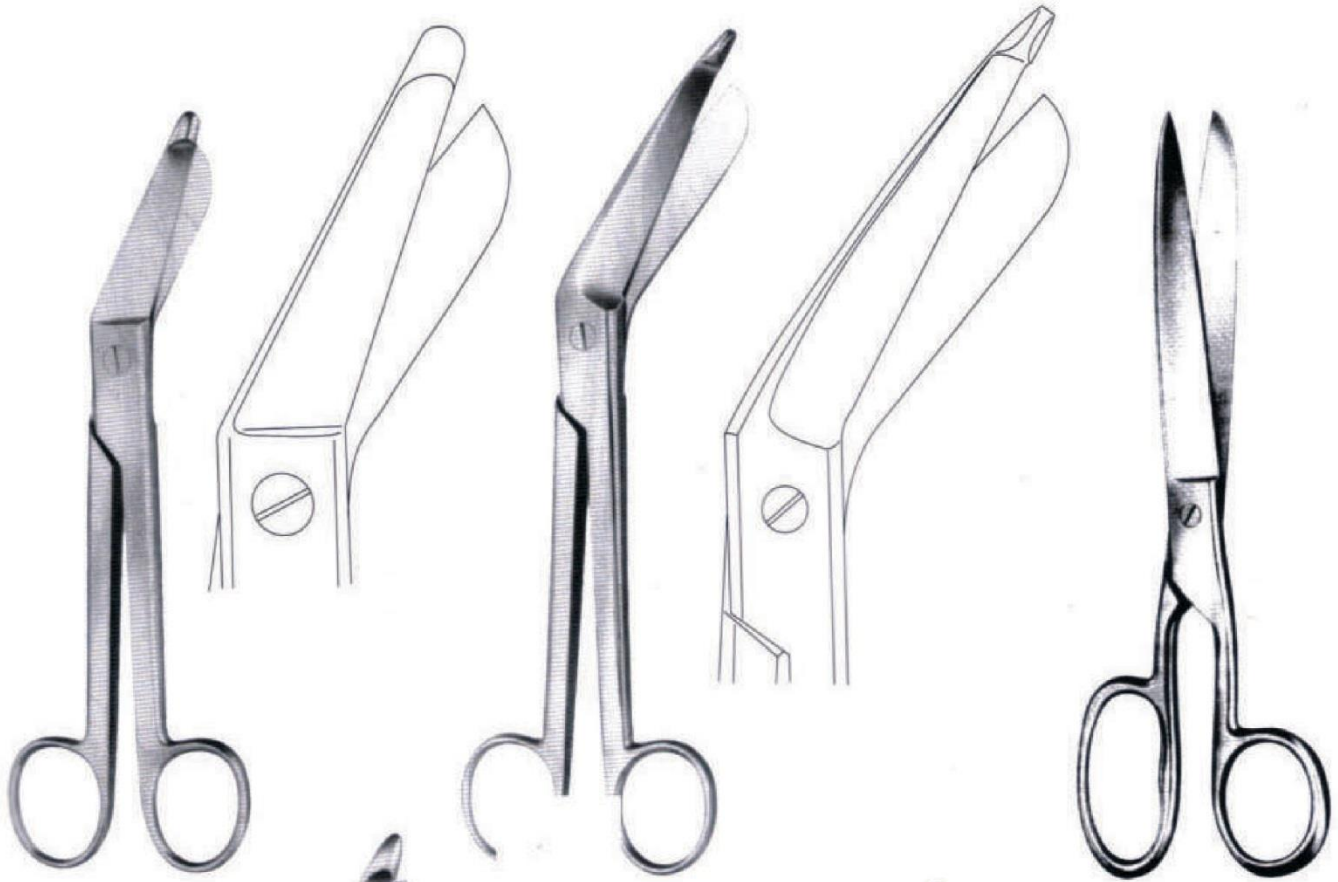

Esmarch
 Jo-21-124 20 cm / 8"
 Jo-21-125 22 cm / 8 3/4"

bergmann
 Jo-21-126
 23 cm / 9"

Smith [Mod. USA]
 Jo-21-127
 20 cm / 8"

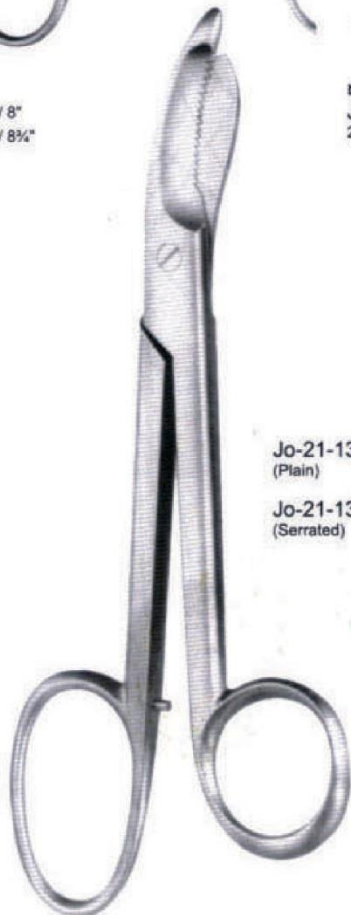

Jo-21-132
 (Plain)

Jo-21-133
 (Serrated)

Bruns
 23.5 / 9 1/4"

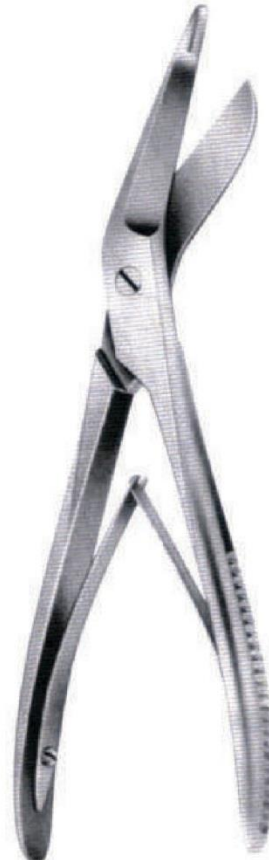

Seutin
 Jo-21-134
 23 cm / 9"

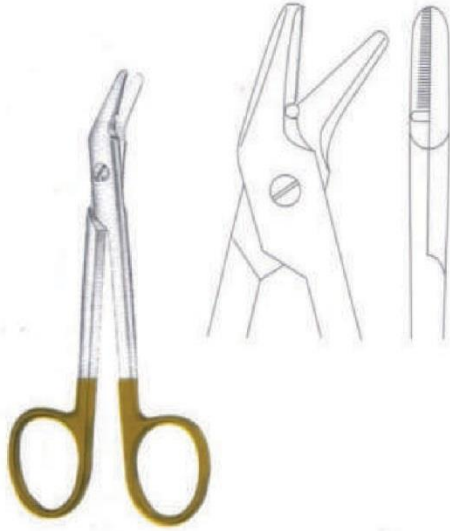

Universal
JT-22-711
12 cm / 5"

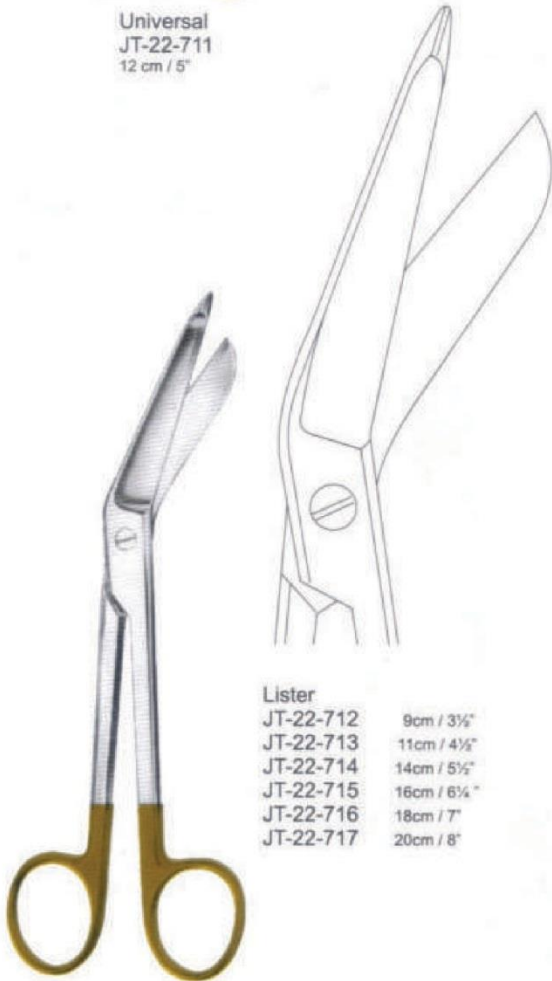

Lister

JT-22-712	9cm / 3½"
JT-22-713	11cm / 4½"
JT-22-714	14cm / 5½"
JT-22-715	16cm / 6¼"
JT-22-716	18cm / 7"
JT-22-717	20cm / 8"



Bruns
JT-22-718
24 cm / 9 ½"

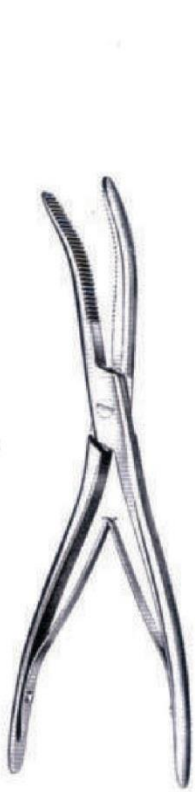

Wolf



Jo-21-143
18 cm / 7"



Jo-21-144
24 cm / 9½"

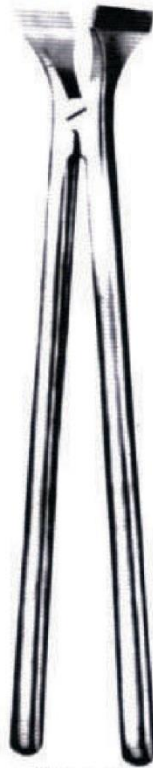

Beeson
Jo-21-145
30 cm / 12"



Hennig
Jo-21-146
28 cm / 11"

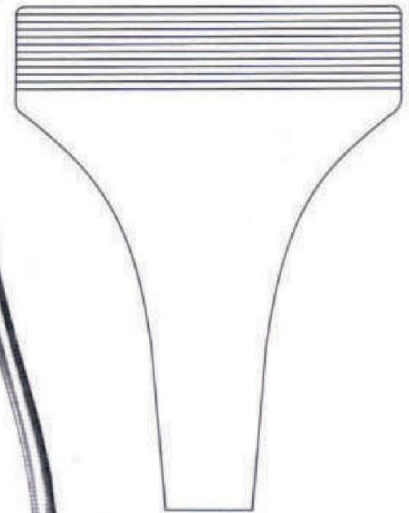

Stille

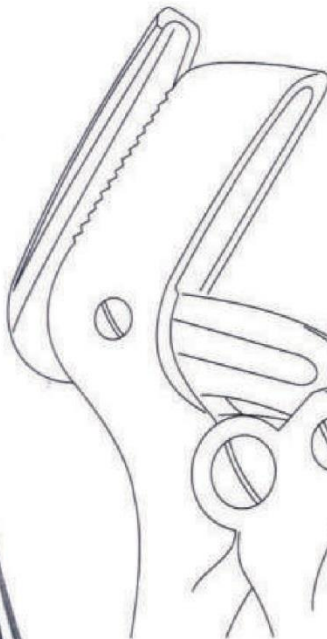

Jo-21-153
23 cm / 9"
Jo-21-153A
Blade without reinforced back

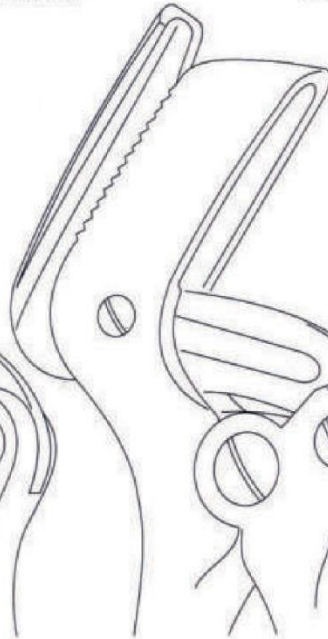

Jo-21-154
26 cm / 10¼"
Jo-21-154A
Blade without reinforced back

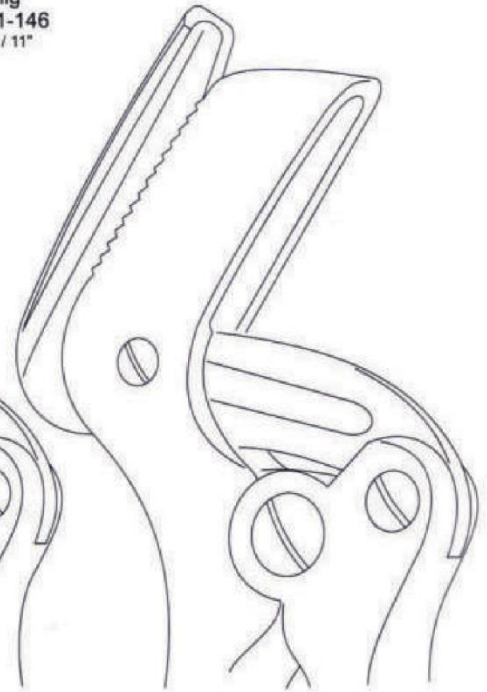

Jo-21-155
37 cm / 14½"
Jo-21-155A
Blade without reinforced back



20 mm Ø
 140 g
 (5 oz)

Jo-21-156
 16.5 cm / 6½"



30 mm Ø
 220 g
 (7¾ oz)

Collin
Jo-21-157
 20 cm / 8"



Williger
 24 cm / 9½"



Jo-21-158
 26 mm Ø
 300 g (10½ oz)

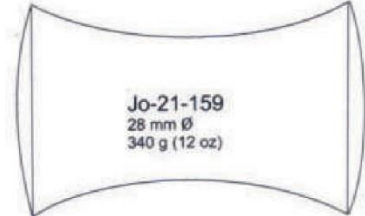

Jo-21-159
 28 mm Ø
 340 g (12 oz)

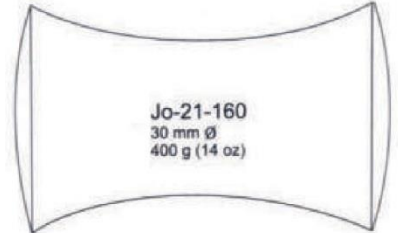

Jo-21-160
 30 mm Ø
 400 g (14 oz)



Lucae
 19 cm / 7½"



Jo-21-161
 19 mm Ø
 230 g (8 oz)

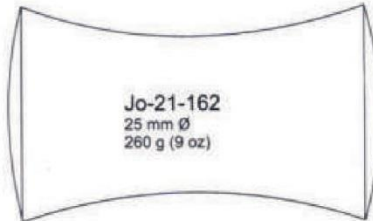

Jo-21-162
 25 mm Ø
 260 g (9 oz)



Doyen
 21 cm / 8¼"

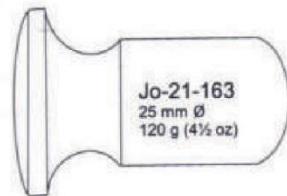

Jo-21-163
 25 mm Ø
 120 g (4½ oz)

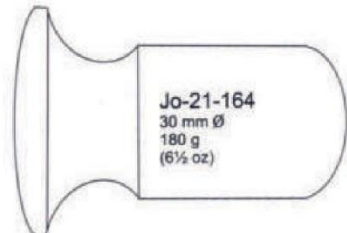

Jo-21-164
 30 mm Ø
 180 g
 (6½ oz)

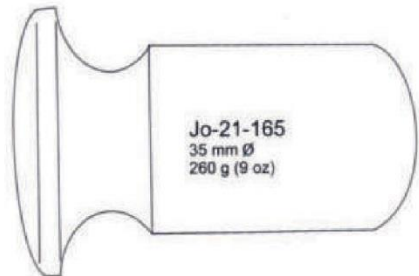

Jo-21-165
 35 mm Ø
 260 g (9 oz)



26 mm \varnothing
 320 g (11¼ oz)

Mead
 Jo-21-166
 Solid
 Jo-21-167 17 cm / 6¾"
 Ferrose II Faces only, pair



22 mm \varnothing
 200 g (7 oz)

Partsch
 Jo-21-168
 18 cm / 7"

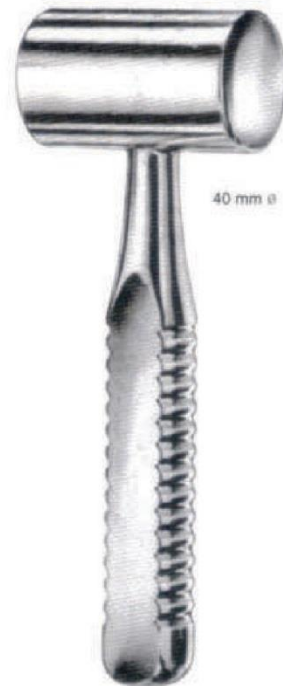

40 mm \varnothing

Heath
 Jo-21-169
 18,5 cm, 7½"
 700 g
 copper filled head



Autoclavable to
 250° F (121° C)

Mallet Lightweight
 Jo-21-170
 19 cm / 7½" with two replaceable
 nylon caps anodized aluminum handle
 weight: 7 oz.
 head weight: 4 oz
 head diameter: 25 mm



Autoclavable to
 250° F (121° C)

Combination Mallet
 with one nylon cap and one solid stainless side
 Jo-21-171 Jo-21-172
 19 cm / 7½" 19 cm / 7½"
 weight: 9 oz weight: 12 oz
 head weight: 5 oz head weight: 8 oz
 head diameter: 26 mm head diameter: 38 mm



Jo-21-173
26 cm / 10½"



Jo-21-175
26 cm / 10½"



Jo-21-176
26 cm / 10½"



Aufricht Rasp
 21 cm / 8 1/4"



Jo-21-191
 Single ended
 forward cutting
 9 mm width

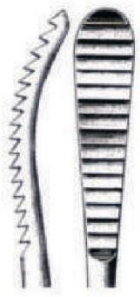

Jo-21-192
 Single ended
 backward cutting
 9 mm width



Maltz Rasp
 Jo-21-193
 18 cm / 7" Single ended
 backward cutting
 10 mm width



Joseph Rasp
 Jo-21-194
 16 cm / 6 1/4" Single ended
 8 mm at wide point
 fine cross serrations

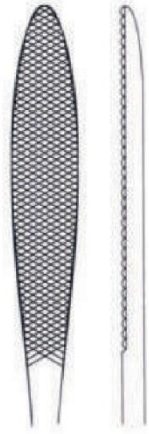

Jo-21-1137
 Excision
 Arthroplasty Rasp
 17 cm / 6 1/2"
 stainless steel



Jo-21-1136
 Trochlear Rasp
 17 cm / 6 1/2"
 stainless steel



Lewis Rasp
 Jo-21-195
 19 cm / 7 1/2"
 fine Single ended
 8 mm width



Plain Serrations
 Jo-21-196
 19 cm / 7 1/2" coarse
 Single ended
 8 mm width



Cottle Rasp
 Jo-21-197
 20.5 cm / 8"
 single ended, backward cutting
 9 mm width, plain serration

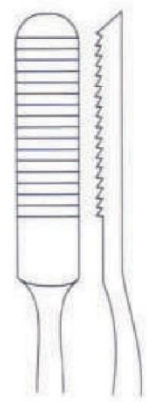



Olivecrona
 Jo-21-212 30 cm, 12°
 Jo-21-213 40 cm, 16°
 Jo-21-214 50 cm, 20°
 Jo-21-215 70 cm, 28°



Gigli
 Jo-21-216 30 cm, 12°
 Jo-21-217 40 cm, 16°
 Jo-21-218 50 cm, 20°
 fine, 6 wires twisted
 Jo-21-219 50 cm, 20°



Gigli-Handle
 Jo-21-220

Blade
 23 cm



Charriere
 Jo-21-223
 35 cm / 14"

Blade
 1. 14 cm
 2. 18 cm
 3. 20 cm



Charriere / Fergusson
 1. Jo-21-224 23 cm
 2. Jo-21-224A 26 cm
 3. Jo-21-224B 30 cm

Blade
 23 cm



Satterlee
 Jo-21-225

Blade
 25cm



Helferich-Bier
 Jo-21-226



SV-0651-30
 30 cm
 Blade 20 cm
 Post Mortem Saw



Butcher
 SV-0652-00
 Blade 45 cm
 Post Mortem Saw



SV-0653-00
 Blade 40 cm
 Post Mortem Saw

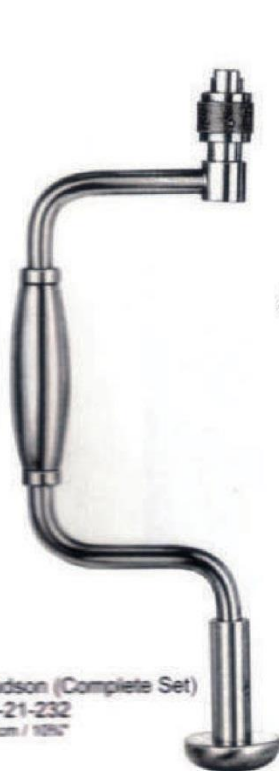

Hudson (Complete Set)
 Jo-21-232
 27 cm / 10 5/8"



Jo-21-233



Jo-21-234
 9 mm ø



Jo-21-235
 14 mm ø



Jo-21-236
 16 mm ø



Jo-21-237
 22 mm ø



Jo-21-238
 14 mm ø



Jo-21-239
 2 mm ø



Jo-21-240
 13 mm ø



Jo-21-241
 16 mm ø



Jo-21-264
 Handle with chuck and Key, accommodating up to 6.35 mm (1/4"), perforated, for inserting and extracting nails, guide pins, and wire guide drills.



Ralk
Jo-21-261



Jo-21-1133k

Jo-21-1133
Pin Chuck
 15 cm up to 6.35 mm diameter
 14 cm up to 4.50 mm diameter

- To introduce bone pin
- with jacob chuck
- fully cannulated
- autoclave able



Jo-21-1134

Screw Drivers (Ferozell Handle)

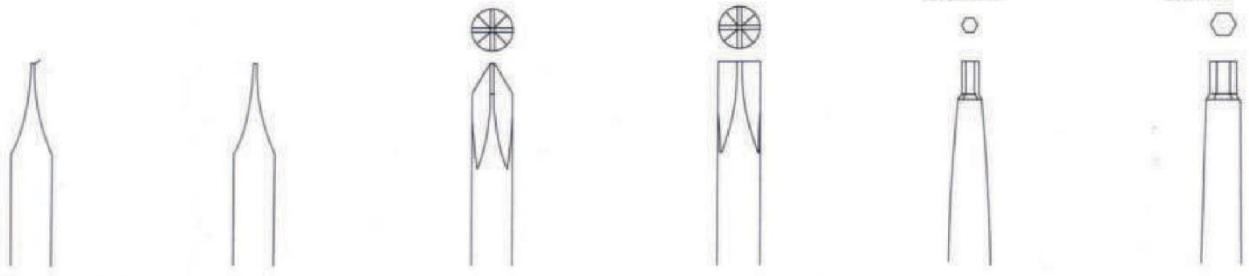

Jo-21-265
17 cm / 6 1/2"

Lane
Jo-21-266
25 cm / 10"

Jo-21-267
17 cm / 6 1/2"
Jo-21-267A
25 cm / 10"

Jo-21-268
17 cm / 6 1/2"
Jo-21-268A
25 cm / 10"

Hexagon
Jo-21-269
17 cm / 6 1/2"
Jo-21-269A
25 cm / 10"

Hexagon
Jo-21-270
17 cm / 6 1/2"
Jo-21-270A
25 cm / 10"



Martini
Jo-21-276 B
 140 mm, 5½"



Williger
Jo-21-278
 145 mm, 5¾"



Volkmann
Jo-21-281
 145 mm, 5½"



Volkmann
Jo-21-282
 170 mm, 6¾"



Jo-21-284
 160 mm, 6¼"



Volkmann
 170 mm, 6¾"



Jo-21-286
 Fig. 0000



Jo-21-287
 Fig. 000



Jo-21-288
 Fig. 00



Jo-21-289
 Fig. 0



Jo-21-290
 Fig. 1



Jo-21-291
 Fig. 2



Jo-21-292
 Fig. 3



Jo-21-293
 Fig. 4



Jo-21-294
 Fig. 5



Jo-21-295
 Fig. 6



Lambotte-Osteotome
25 cm, 10"

- Jo-21-513B 4 mm
- Jo-21-513C 8 mm
- Jo-21-513D 10 mm
- Jo-21-513E 13 mm
- Jo-21-513 15 mm
- Jo-21-513F 18 mm
- Jo-21-514 20 mm
- Jo-21-515 25 mm
- Jo-21-516 30 mm
- Jo-21-517 38 mm
- Jo-21-518 44 mm
- Jo-21-519 50 mm



Mini-Lambotte-Osteotome
12.5 cm / 5"

- Jo-21-501 4 mm
- Jo-21-502 6 mm
- Jo-21-503 8 mm
- Jo-21-504 10 mm
- Jo-21-505 12 mm
- Jo-21-505A 15 mm



Mini-Lexer
18 cm, 7"

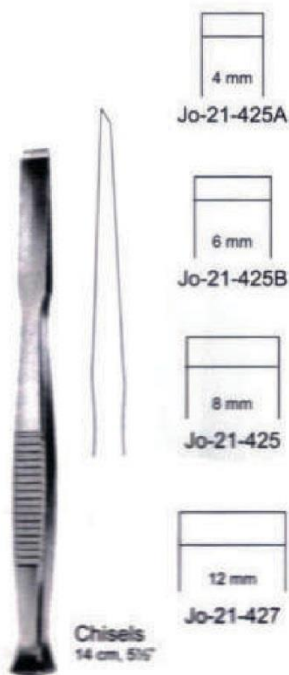
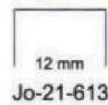

Chisels
14 cm, 5 1/2"



Gouges
14 cm, 5 1/2"



Smillie
17 cm, 6 3/4"



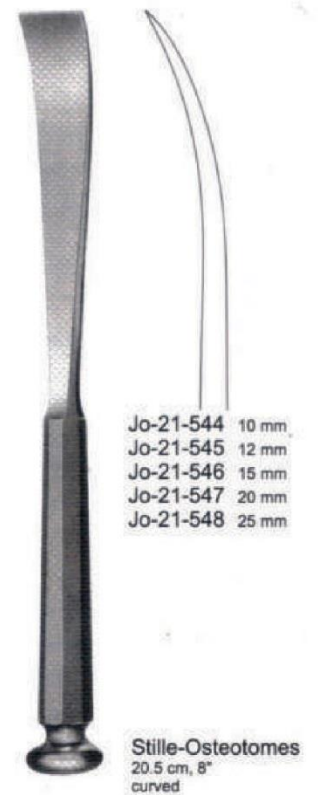
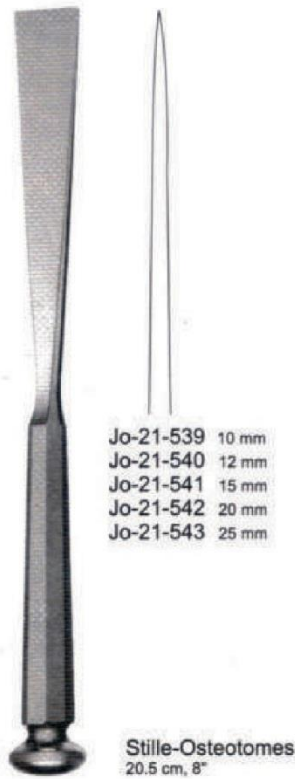
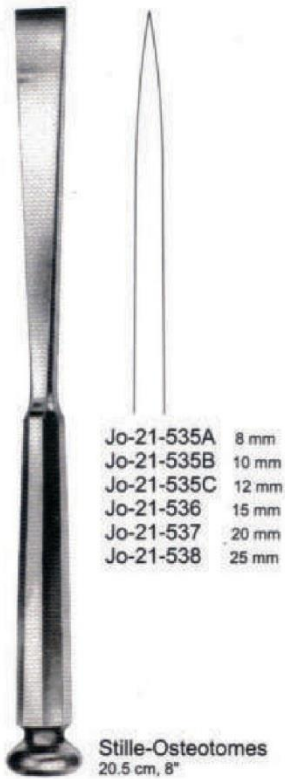
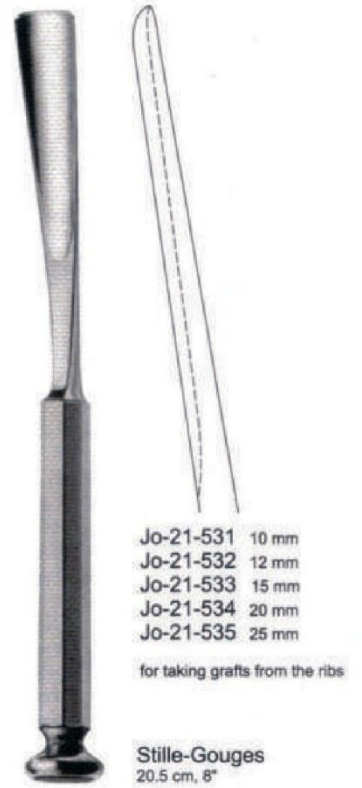
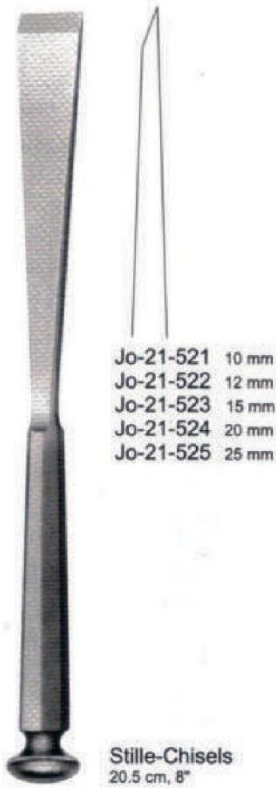



Jo-21-670 B
 170 mm, 6 3/4"



Williger
 Jo-21-690
 140 mm, 5 1/2"

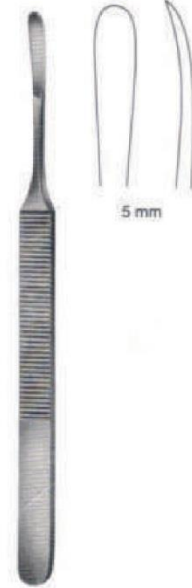

König
 Jo-21-690 A
 155 mm, 6"



Williger
 Jo-21-691
 160 mm, 6 1/4"



Jo-21-717
 185 mm, 7 1/4"



Jo-21-718
 185 mm, 7 1/4"



Jo-21-719
 185 mm, 7 1/4"

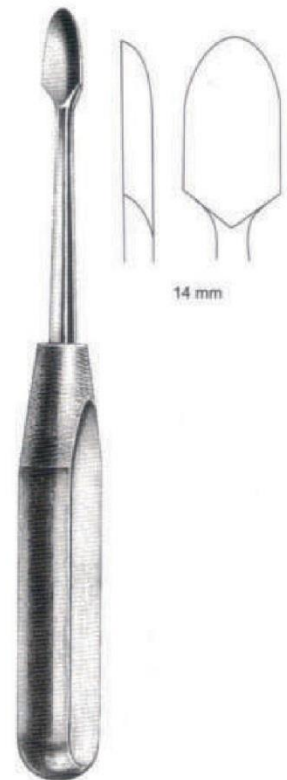

Jo-21-720
 195 mm, 7 3/4"



Freer
 J-32-1300
 185 mm, 7 1/4"
 Sharp/blunt



Jo-21-724 A
 150 mm, 6"



Jo-21-724 B
 150 mm, 6"

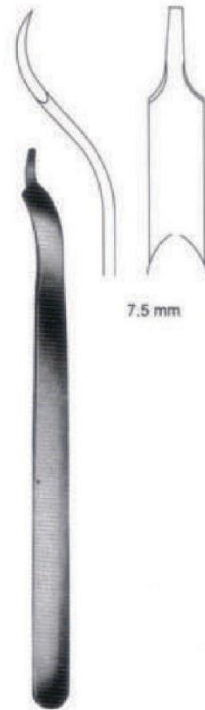

Buck-Gramcko
 Jo-21-724 C
 150 mm, 6"



Williger
 Jo-21-669
 175 mm, 7"

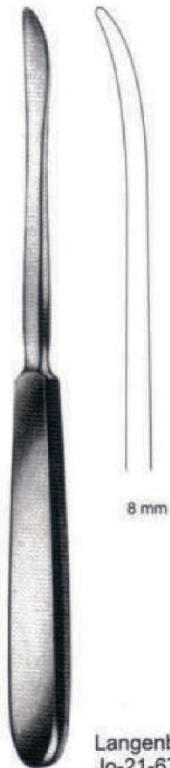

Langenbeck
 Jo-21-673
 200 mm, 8"

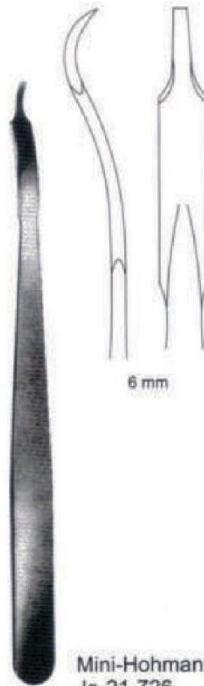

Mini-Hohmann
 Jo-21-726
 160 mm, 6 1/4"

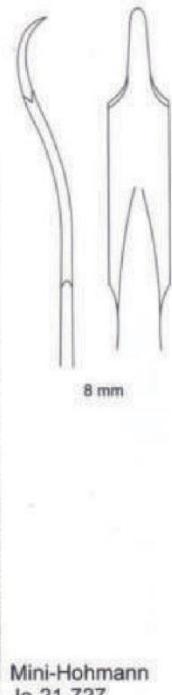

Mini-Hohmann
 Jo-21-727
 160 mm, 6 1/4"



Hohmann
Jo-21-728
8 mm

Hohmann
Jo-21-729
18 mm

Hohmann
Jo-21-730
43 mm

Hohmann
Jo-21-731
70 mm



Hohmann
Jo-21-732
43 mm

Hohmann
Jo-21-733
22 mm

Hohmann
Jo-21-734
33 mm

Hohmann
Jo-21-735
24 mm

Hohmann
Jo-21-736
22 mm

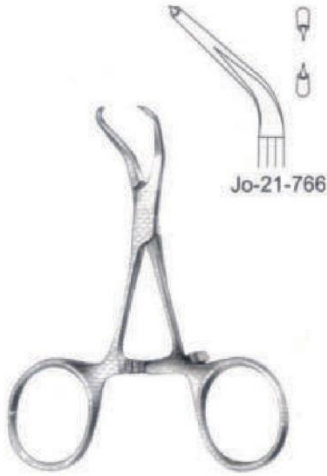

Jo-21-766

Reposition forceps
with stepped tips
9.5 cm / 3¾"

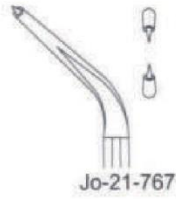

Jo-21-767



Jo-21-768
13.5 cm, 5½"

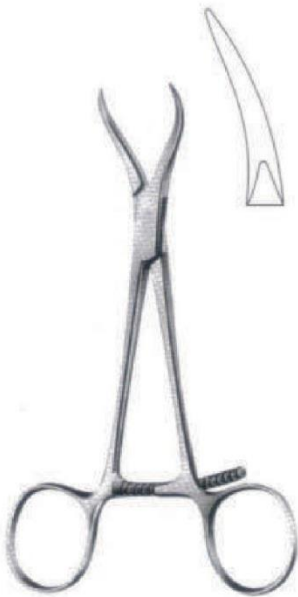

Jo-21-769
Reposition forceps,
especially for maxillary
reposition
13.5 cm, 5½"



Haase
Jo-21-770
Reposition forceps, for
mandibular fractures
16.5 cm, 6½"

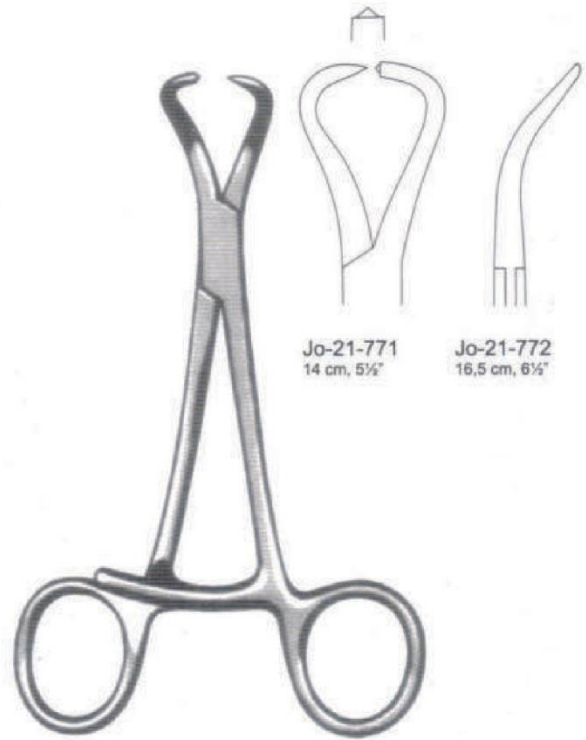

Jo-21-771
14 cm, 5½"

Jo-21-772
16.5 cm, 6½"

Bone Reduction Forceps
Curved

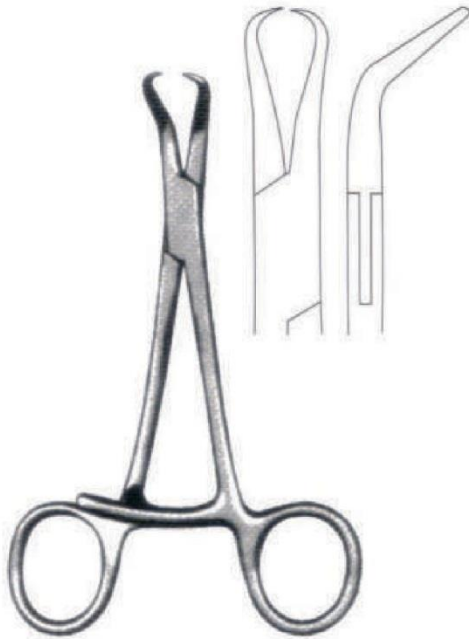

**Stagbeetle Bone
 Reduction Forceps**
Jo-21-773
 12 cm / 4 3/4" curved
 pointed tips

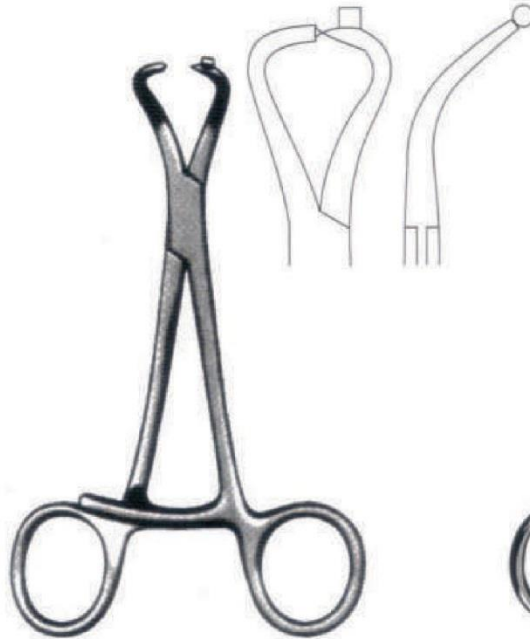

Bone Holding Forceps
Jo-21-774
 13 cm, 5 1/4" curved
 with 1.6 mm k-wire guide



Bone Holding Forceps
Jo-21-774 A



Bone Holding Forcep
Jo-21-775
 17 cm, 6 3/4" curved
 with 1.1 mm k-wire guide



Jo-21-776
 13.5 cm / 5 1/2"

Jo-21-777
 12.5 cm / 5"

Bone Holding Forceps
 Serrated with pointed tips
 curved

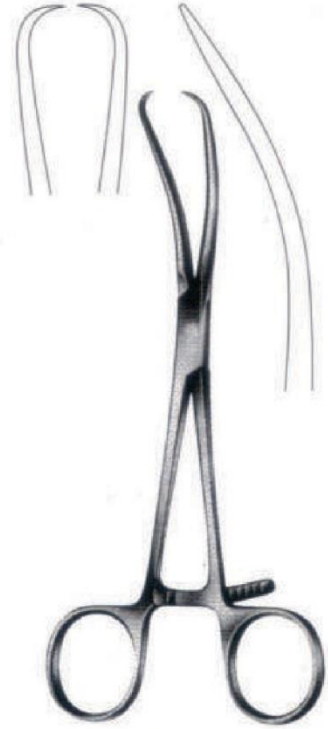

Reil Bone Reduction Forcep
Jo-21-778
 17.5 cm, 7" curved
 pointed tips



Bone Reduction Forcep
 Jo-21-779
 20 cm, 8"



1 x 1 sharp points
 Grasping forceps
 for small bones

Malleolar Forcep
 Jo-21-780
 21 cm, 8 1/4"

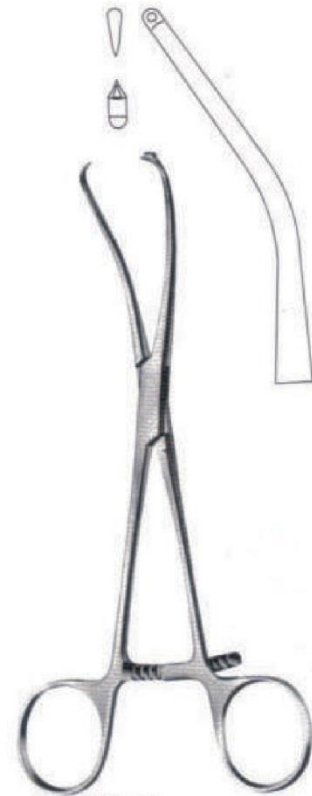

Meyer
 Jo-21-781
 17 cm, 6 3/4"
 Reposition forcep for gers,
 with drill guide for kirschner
 wires up diameter 1.0 mm

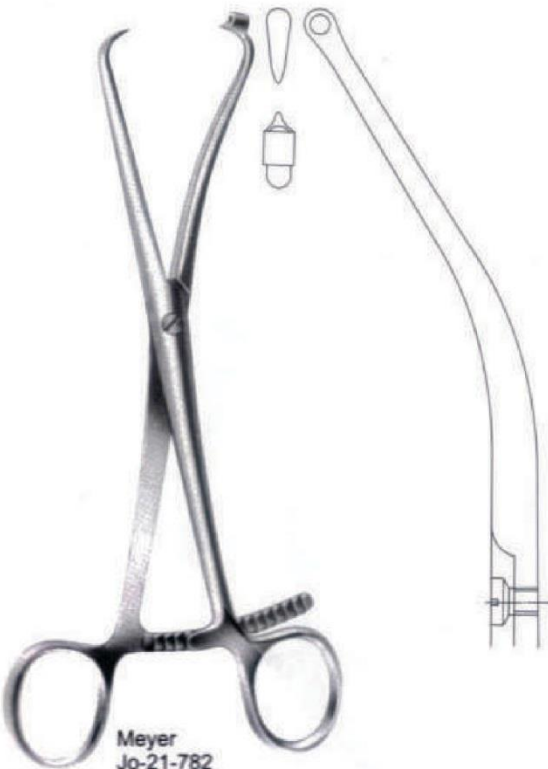

Meyer
 Jo-21-782
 20.5 cm / 8"
 Reposition forceps
 with drill guide for kirschner
 wires up to diameter 2.0 mm



Jo-21-783
 14 cm, 5 1/2"

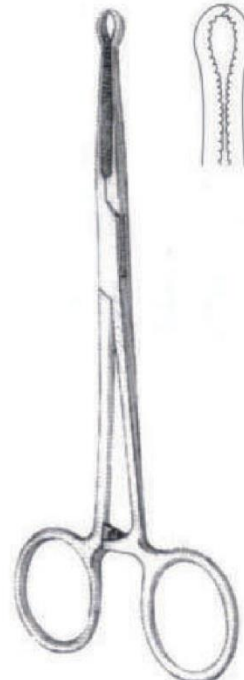

Locke Phalangeal Forcep
 Jo-21-784
 15 cm, 6"
 serrated jaws
 1 x 1 teeth



Bone Reduction Forceps
Jo-21-785
 14 cm, 5½" small curved
 ratchet length: 1½"



Jo-21-786
 12 cm, 4½"



Jo-21-786A
 19 cm, 7½"



Lewin
Jo-21-787
 17.5 cm, 7"

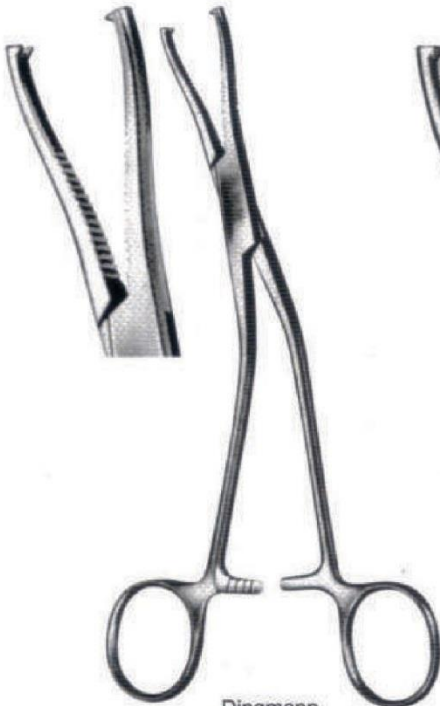

Dingmann
Jo-21-788
 18,5 cm, 7¼"



Dingmann
Jo-21-789
 18,5 cm, 7¼"

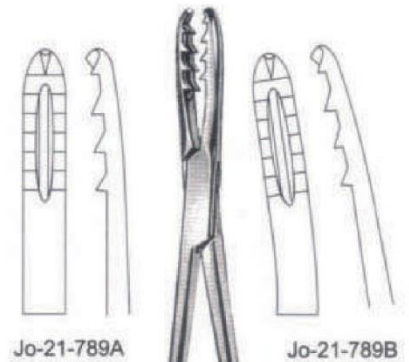

Jo-21-789A

Jo-21-789B

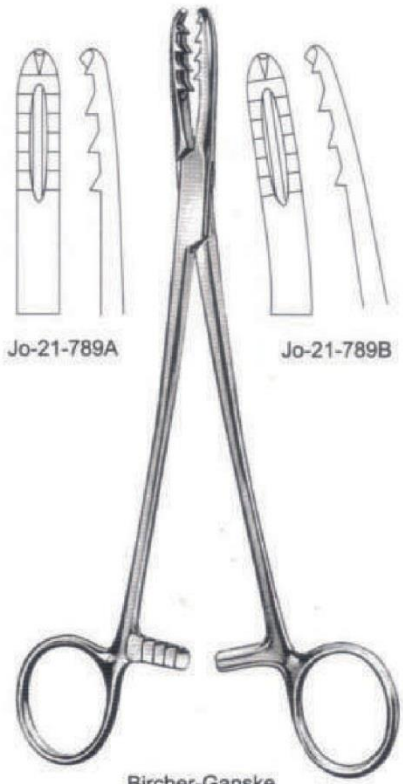

Bircher-Ganske
 20 cm, 8"



Kern
 Jo-21-798 12 cm, 4 3/4"
 Jo-21-799 15 cm, 6"
 Jo-21-799A 17 cm, 6 3/4"
 Jo-21-799B 21 cm, 8 1/4"



Kern
 Jo-21-800 12 cm, 4 3/4"
 Jo-21-801 15 cm, 6"
 Jo-21-801A 17 cm, 6 3/4"
 Jo-21-801B 21 cm, 8 1/4"
 with ratchet



Langenbeck
 Jo-21-793
 21 cm / 8 1/4"

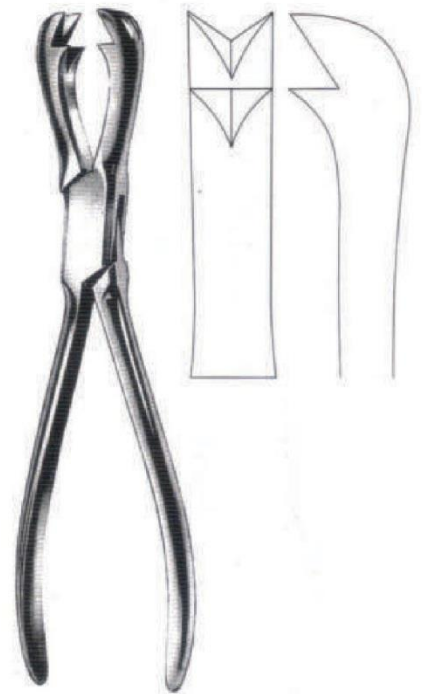

Fergusson
 Jo-21-794
 21 cm / 8 1/4"

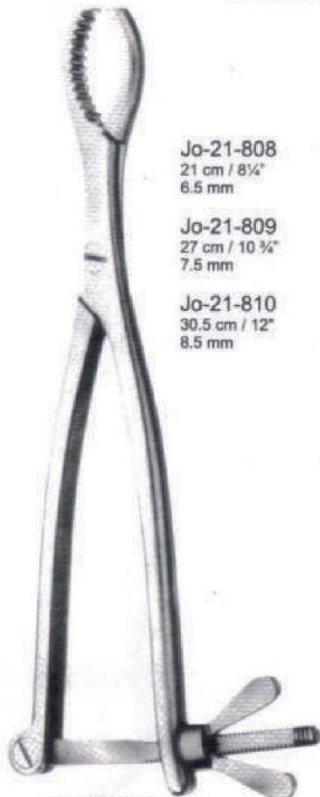

Hey Groves

Jo-21-808
 21 cm / 8 1/4"
 6.5 mm
Jo-21-809
 27 cm / 10 3/4"
 7.5 mm
Jo-21-810
 30.5 cm / 12"
 8.5 mm

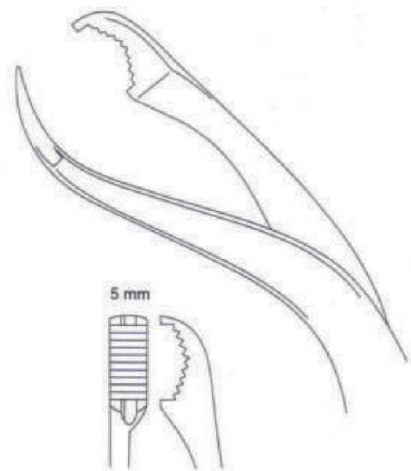

Verbrugge Mini
 Jo-21-814
 17.5 cm, 6 3/4"

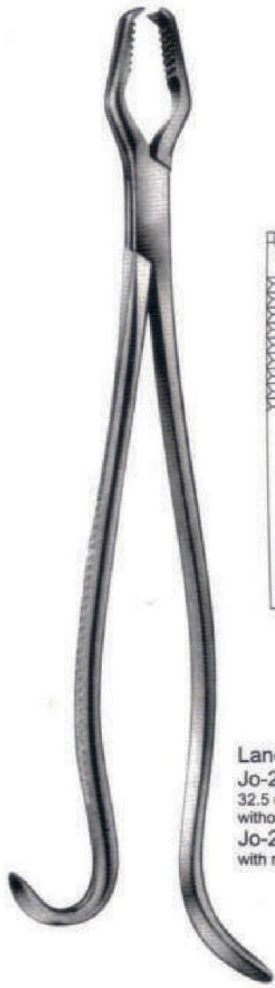

Lane Bone Holding Forceps
 Jo-21-802
 32.5 cm / 13"
 without ratchet, light model
 Jo-21-803
 with ratchet

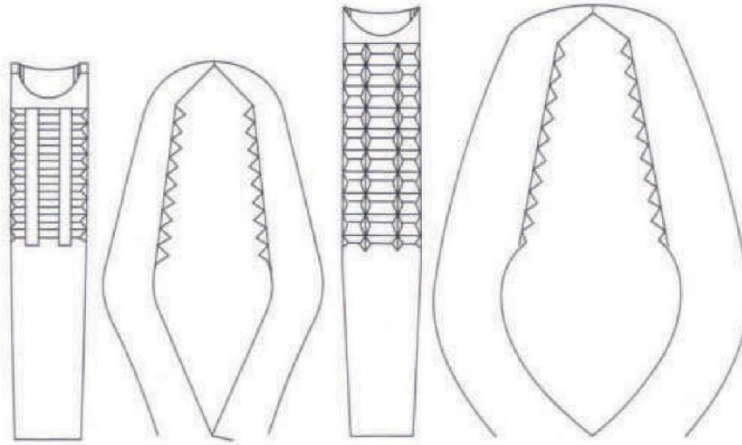

Lane Bone Holding Forceps
 Jo-21-804
 32.5 cm / 13" Standard Model
 without ratchet
 Jo-21-805
 32.5 cm / 13" Standard Model
 with ratchet



Lane Bone Forcep
 Jo-21-806
 42.5 cm / 17"
 without ratchet

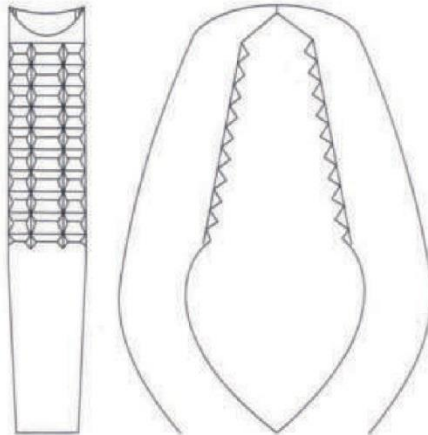

Lane Bone Forcep
 Jo-21-807
 42.5 cm / 17"
 with ratchet

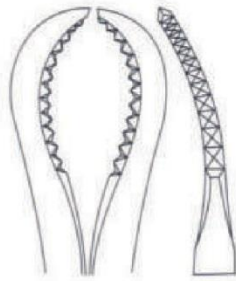
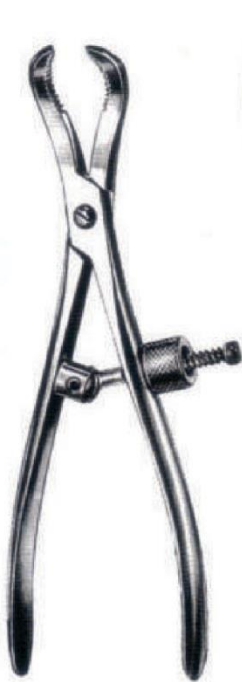

Jo-21-817 16 cm, 6¼"
 Jo-21-818 24 cm, 9½"

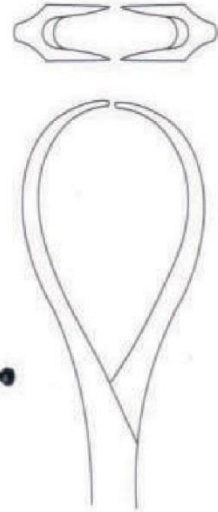
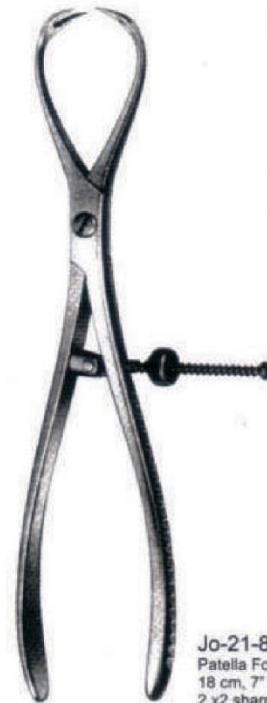

Jo-21-819
 Patella Forceps
 18 cm, 7" with speed lock
 2 x 2 sharp teeth

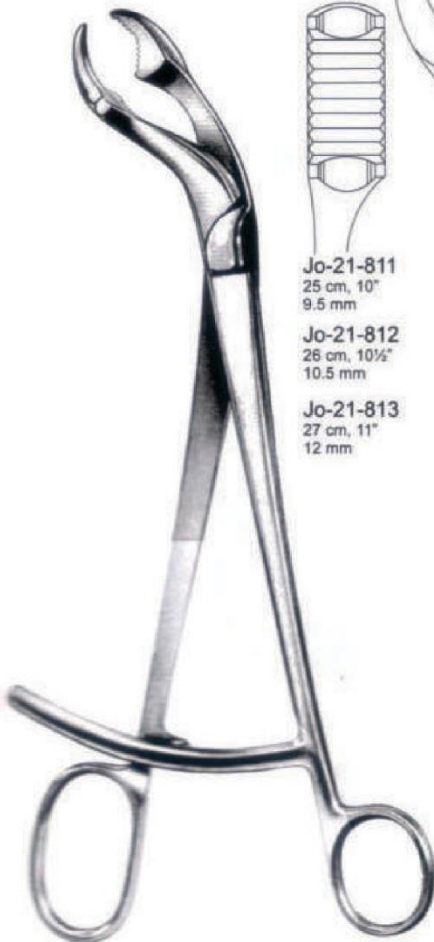

Jo-21-811
 25 cm, 10"
 9.5 mm
 Jo-21-812
 26 cm, 10½"
 10.5 mm
 Jo-21-813
 27 cm, 11"
 12 mm

Verbrugge

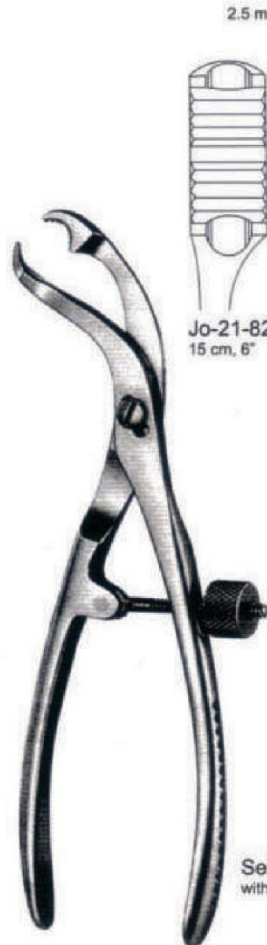

2.5 mm

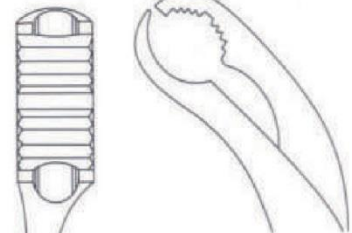

Jo-21-820 15 cm, 6"
 Jo-21-821 19 cm, 7½"
 Jo-21-822 24 cm, 9½"
 Jo-21-823 26 cm, 10¼"
 Jo-21-824 28 cm, 11"

Jo-21-820-S
 Special mini size
 12 cm, 4¾"

Self-Conforming Forceps
 with thread fixation

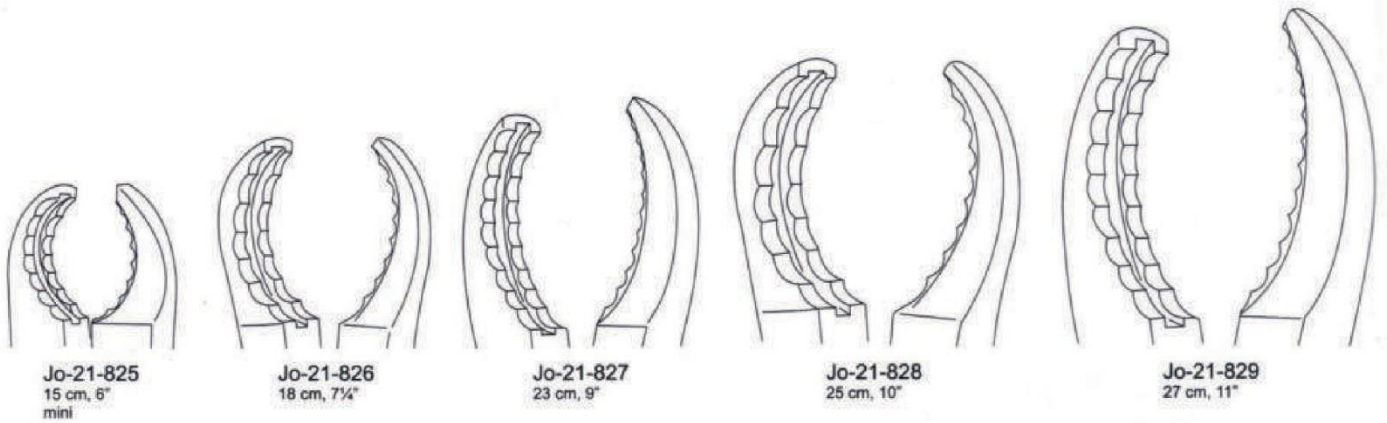

Ulrich
 Jo-21-825 15 cm, 6" mini
 Jo-21-826 18 cm, 7¼"
 Jo-21-827 23 cm, 9"
 Jo-21-828 25 cm, 10"
 Jo-21-829 27 cm, 11"
 Straight

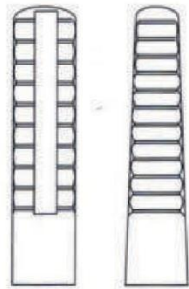

Ulrich
 Jo-21-830 15 cm, 6"
 Jo-21-830A 18 cm, 7¼"
 Jo-21-830B 23 cm, 9"
 Jo-21-830C 25 cm, 10"
 Jo-21-830D 27 cm, 11"
 curved

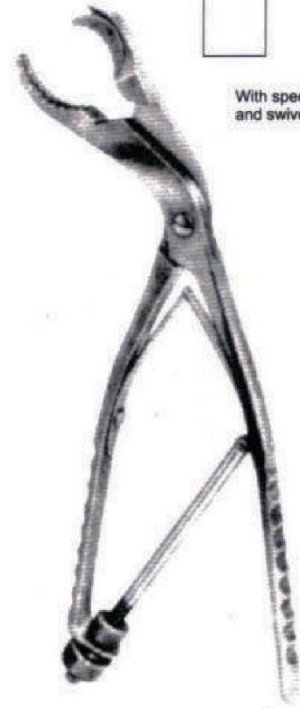
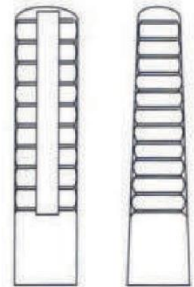

With speed lock
and swivel jaw

Ulrich Self-Retaining Forceps
 Jo-21-831
 27 cm, 11"
 angular

Calibrated in inches

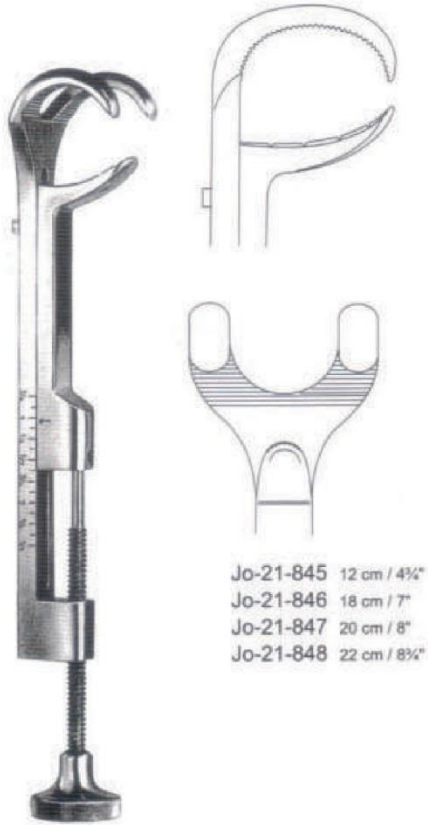

- Jo-21-845 12 cm / 4 1/2"
- Jo-21-846 18 cm / 7"
- Jo-21-847 20 cm / 8"
- Jo-21-848 22 cm / 8 1/2"

Gerster-Lowmann

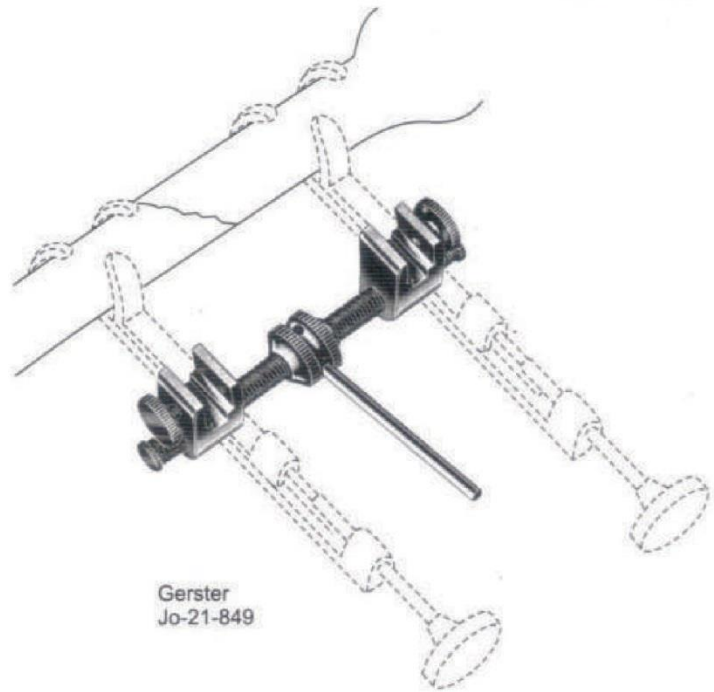

Gerster
Jo-21-849

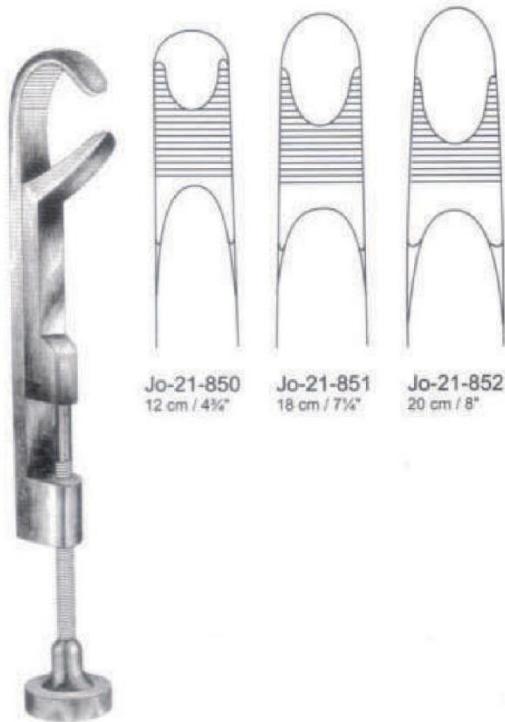

- Jo-21-850 12 cm / 4 1/2"
- Jo-21-851 18 cm / 7 1/4"
- Jo-21-852 20 cm / 8"

Lowmann Bone Clamp
1 X 1 Jaws



Jo-21-853
18.5 cm / 7 1/4"

Jo-21-854
20 cm / 8"

Lowmann Bone Clamp
2 X 2 Jaws

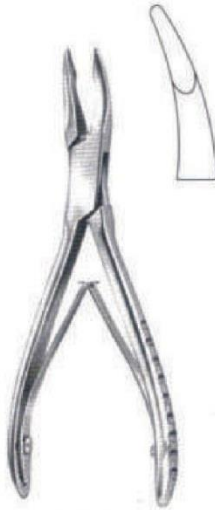

Mini-Friedman
 Jo-21-855
 12,5 cm, 5"



Friedman
 Jo-21-856
 14 cm, 5½"



Mini-Friedman Rongeur
 15 cm, 6"
 Delicate
 2 x 6 mm bite

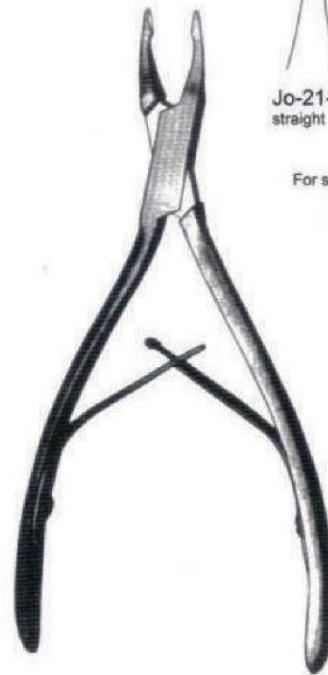

Micro Friedman Rongeur
 14 cm, 5½"
 extremely delicate
 1.5 x 5 mm bite

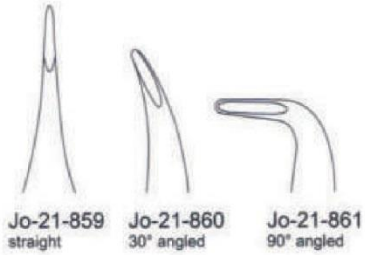

For soft tissue and cancellous bone only.



Jansen
18 cm, 7"



Jo-21-870



Jo-21-871



Jo-21-872



Jansen
18 cm, 7"



Jo-21-873



Jo-21-874



Blumenthal
15 cm, 6"



Jo-21-875



Jo-21-876

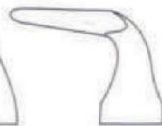

Jo-21-877



Luer
15 cm, 6"



Jo-21-878

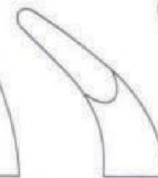

Jo-21-879



Jo-21-880



Luer
17 cm, 6 3/4"



Jo-21-881



Jo-21-882



Jansen
Jo-21-885
19 cm, 7 1/2"

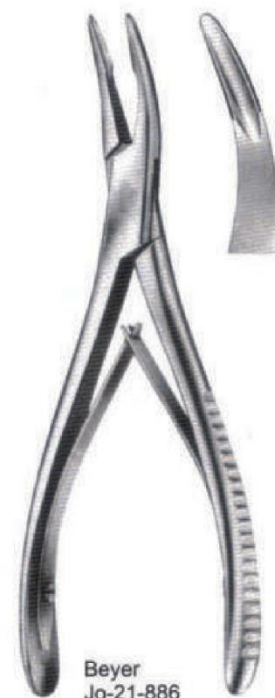

Beyer
Jo-21-886
18 cm, 7"



Olivecrona
Jo-21-887
20,5 cm, 8"



Wilms
Jo-21-892
21 cm, 8 1/4"

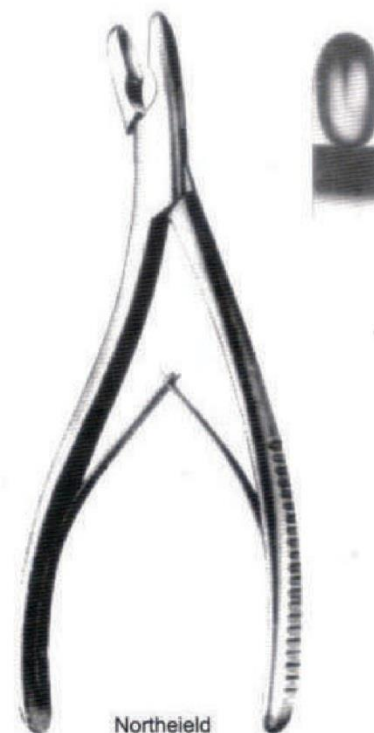

Northeild
Jo-21-890
20,5 cm, 8"

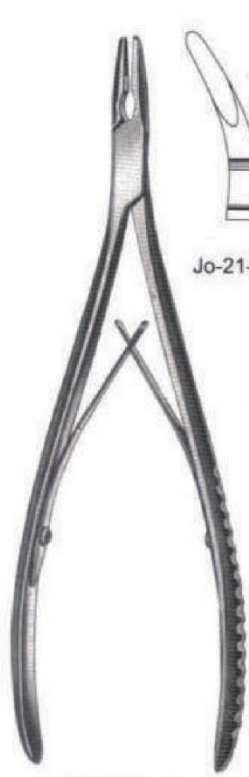

Lempert
19 cm, 7½"

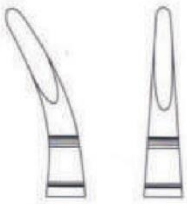

Jo-21-895 Jo-21-894

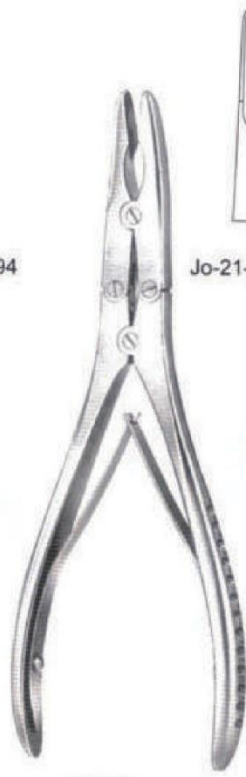

Bohler
15 cm, 6"



Jo-21-896 Jo-21-897

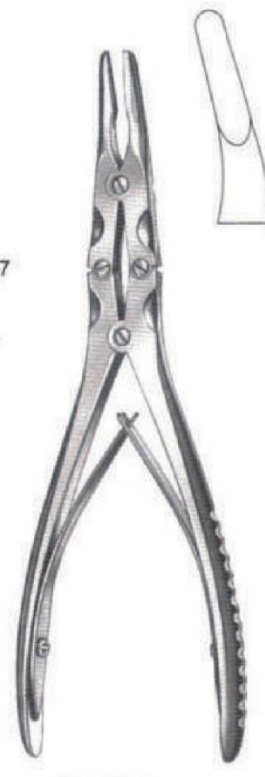

Zaufal - Jansen
Jo-21-898
18 cm, 7"



Mayfield
Jo-21-899
17 cm, 6¾"



Ruskin

Jo-21-901
15 cm / 6"
Straight, delicate
2 x 14 mm bite

Jo-21-902
18 cm / 7"
straight

Jo-21-903
18 cm / 7"
curved



Ruskin
Jo-21-904
23 cm / 9"

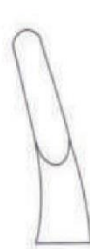

Beyer
Jo-21-900
18 cm / 7"



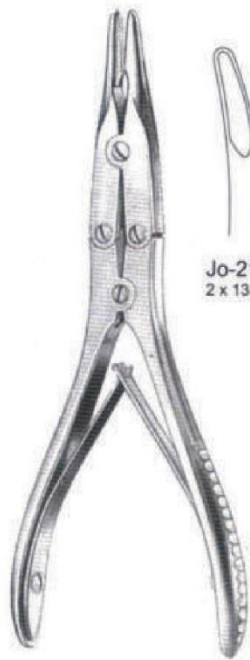

Jo-21-909
2 x 13 mm bite

Kleinert-Kutz
Synovectomy Rongeur
15 cm, 6"

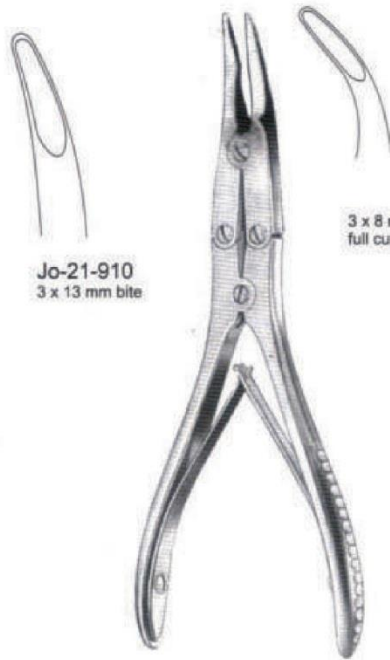

Jo-21-910
3 x 13 mm bite

Jo-21-911
15 cm, 6"



3 x 8 mm bite
full curve delicate



curved on side delicate
2 x 10 mm bite

Kleinert-Kutz
Jo-21-912
15 cm, 6"
Synovectomy Rongeur

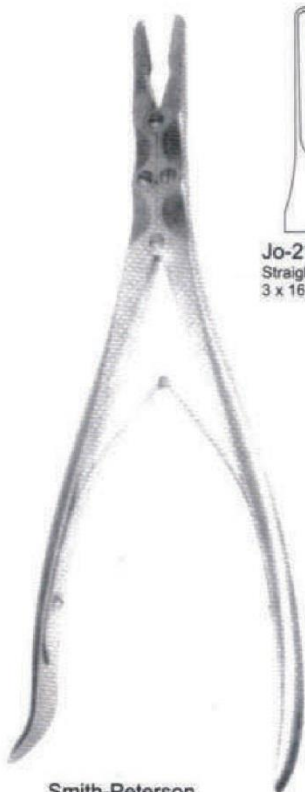

Smith-Peterson
Laminectomy Rongeur
24 cm, 9½"



Jo-21-905
Straight
3 x 16 mm bite



Jo-21-906
Curved
3 x 16 mm bite

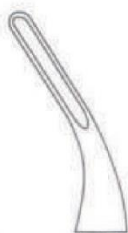

Jo-21-907
Full Curved
3 x 16 mm bite



Stille
Jo-21-918
23 cm, 9"

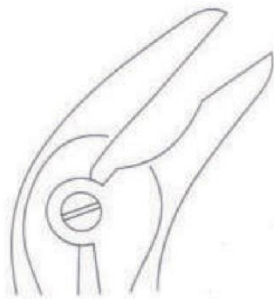

Jo-21-913
2 mm



Jo-21-914
3 mm



Jo-21-915
4 mm

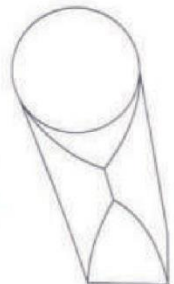

Echlin
23 cm, 9"



Stille- Ruskin
Jo-21-916
23 cm, 9"



Semb
Jo-21-917
22.5 cm, 9"



Jo-21-920
3 x 16 mm bite



Jo-21-921
4 x 16 mm bite

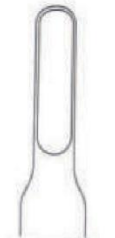

Jo-21-922
5 x 16 mm bite

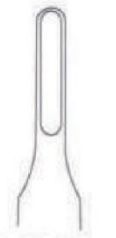

Jo-21-926
3 x 13 mm bite



Jo-21-927
4 x 13 mm bite

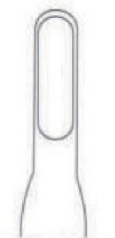

Jo-21-928
5 x 13 mm bite



Jo-21-923
6 x 16 mm bite

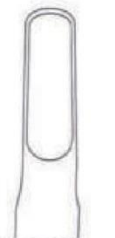

Jo-21-924
7 x 16 mm bite

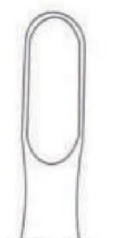

Jo-21-925
8 x 16 mm bite

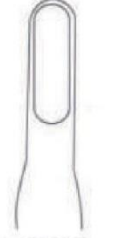

Jo-21-929
6 x 13 mm bite

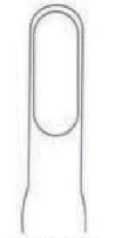

Jo-21-930
7 x 13 mm bite

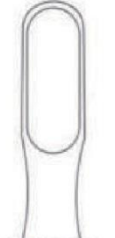

Jo-21-931
8 x 13 mm bite



Leksell - Stille
24 cm, 9½"
15° curve



Leksell Rongeur
23 cm, 9"
50° curve



Jo-21-932
8 mm

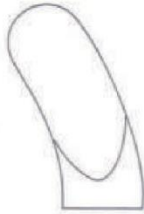

Jo-21-933
8mm

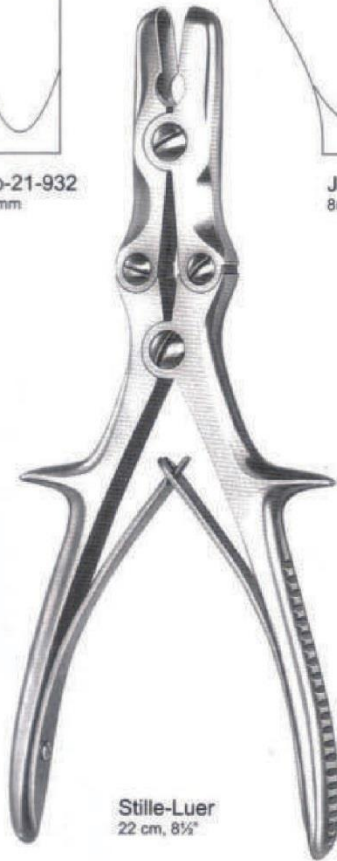

Stille-Luer
22 cm, 8½"



Jo-21-934
23 cm, 9"

Jo-21-935
27 cm, 10½"

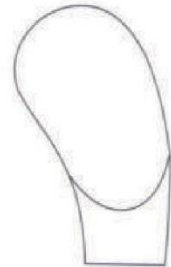

Jo-21-936
23 cm, 9"

Jo-21-937
27 cm, 10½"



Stille-Luer



Liston



Jo-21-941
14 cm, 5½"



Jo-21-942
17 cm, 6½"



Jo-21-943
19 cm, 7½"



Jo-21-944
22 cm, 8½"



Jo-21-945
14 cm, 5½"



Jo-21-946
17 cm, 6½"



Jo-21-947
19 cm, 7½"

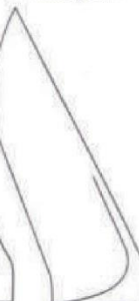

Jo-21-948
22 cm, 8½"

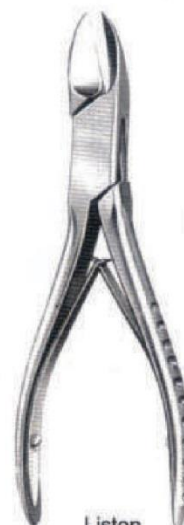

Liston

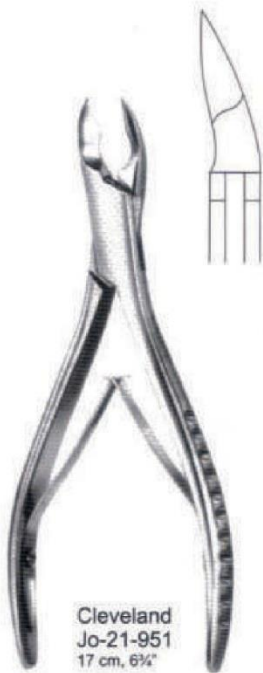

Cleveland
Jo-21-951
17 cm, 6 1/4"



Cleveland
Jo-21-950
15 cm, 6"



Jo-21-949
20 cm, 8"



Stamm
Jo-21-952
15 cm / 6"

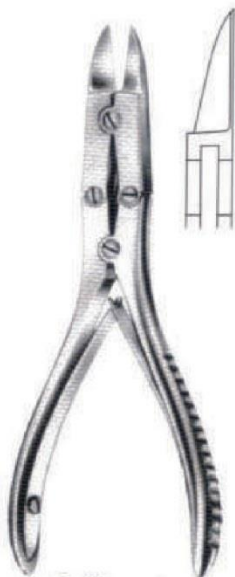

Bohler
Jo-21-958
14,5 cm, 5 1/2"



Bohler
Jo-21-959
14,5 cm, 5 1/2"



Bohler
Jo-21-957
15 cm, 5 3/4"



Jo-21-961
17,5 cm, 7"

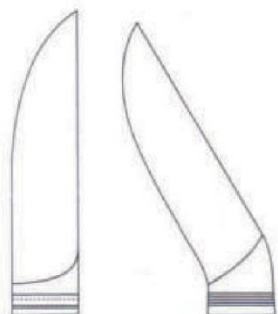

Jo-21-965

Jo-21-966

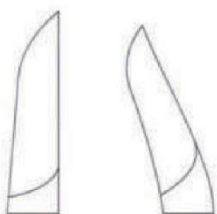
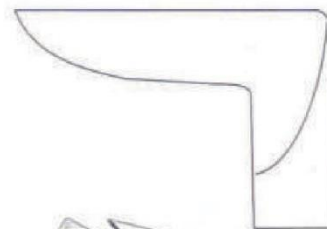

Jo-21-962

Jo-21-963



Ruskin-Liston
18.5 cm / 7 1/2"



Stille Liston
27 cm, 10 1/2"

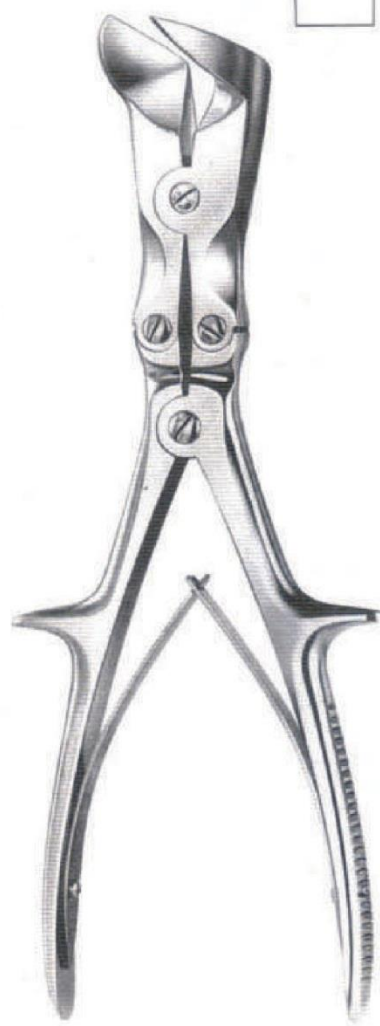

Stille Liston
Jo-21-967
27 cm, 10 1/2"

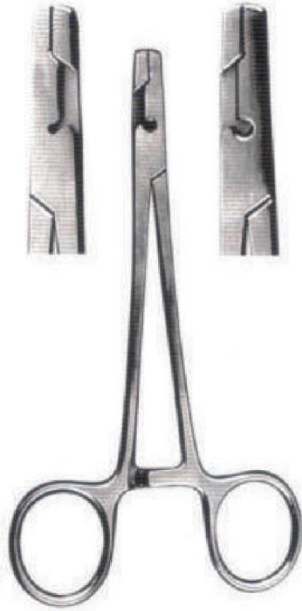

Jo-21-1132
 wire twister / shear cutter
 cuts wire up to 18g / twisted double

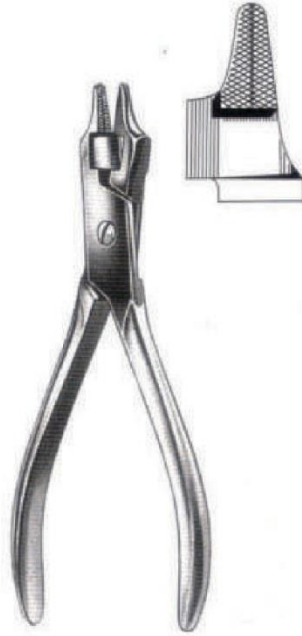

Jo-21-982
 15 cm / 6"



Jo-21-984



Jo-21-985

17 cm / 6 3/4"

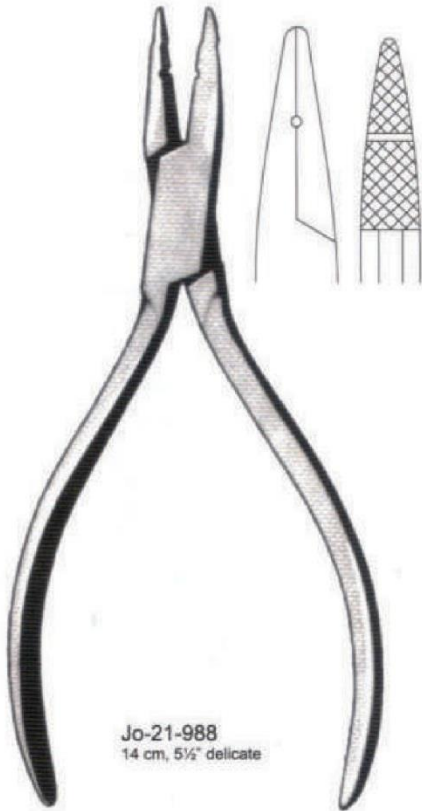

Jo-21-988
 14 cm, 5 1/2" delicate



Flat Nose Pliers
Jo-21-989
 14 cm, 5 1/2" broad

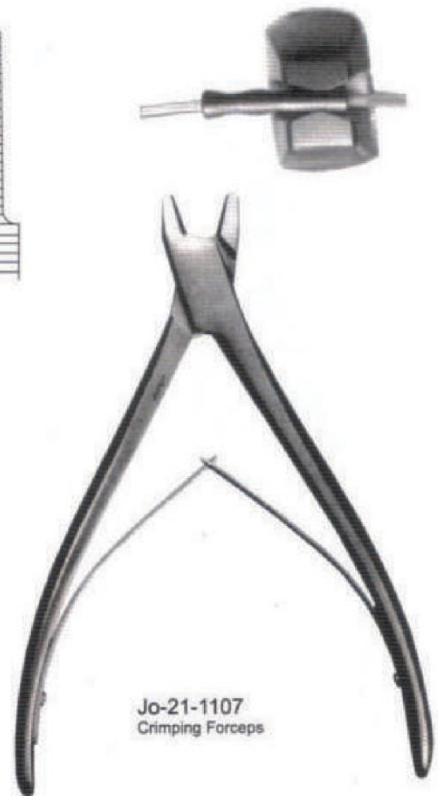

Jo-21-1107
 Crimping Forceps



Jacobs Chuck
 SV-2604-01 Small
 SV-2604-02 Large
 Stainless steel



SV-2605-00
 Key for Jacobs Chuck
 Stainless steel



Wire Tightner
 SV-2603-00



Chuck
 SV-2606-01 Small
 SV-2606-02 Large
 Chrome plated



SV-2607-00
 Key for CP Chuck



Jo-21-1127
 Small Cerclage
 Wire Twister
 18 cm, 7"
 Anodized aluminum handle



Jo-21-1128
 Large
 Anodized aluminum handle



Jo-21-1129



Wire Twister
 Jo-21-1130
 Small
 Stainless steel



Jo-21-1131
 Large Cerclage
 Wire Twister
 18 cm, 7"
 Anodized aluminum handle
 stainless steel tip



Slip Joint Pliers
Jo-21-996
20 cm, 8"
10 mm tip maximum opening 2"

		inside Ø	outside Ø
Jo-21-997	Small	3 mm	5 mm
Jo-21-998	Medium	4 mm	6 mm
Jo-21-999	Large	6 mm	8 mm

Facilitates removal of wire and broken bone screws.



Michele Trephine



Jo-21-1135A ½" id
Jo-21-1135B ¾" id
Jo-21-1135C 1" id
"id" - inner diameter

Horsley's Trephine
10 cm 4"
stainless



SV-2608-00A 2.0 mm
SV-2608-00B 2.7 mm
SV-2608-00C 3.5 mm
SV-2608-00D 4.5 mm

Drill Guide
SV-2608-00



Jo-21-1000
13 cm, 5¼"
Jo-21-1000A
17 cm, 6½"

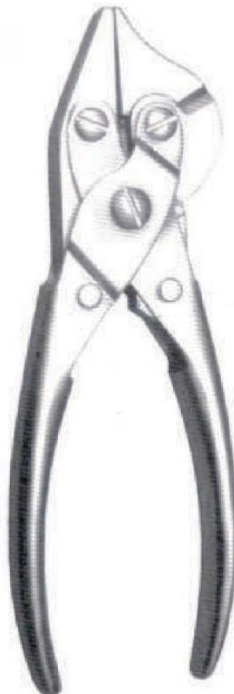

Jo-21-1000 B
17 cm
Jo-21-1000 C
12.5 cm
with side cutter



Jo-21-1001
18 cm, 7"



Surgicon Heavy Duty Locking Pliers & Needle Nose Locking Pliers with a new reinforced, more durable jaw. Heavy Duty jaws lock securely onto pins. Reinforced jaw hinge and jousing are more rigid to help prevent side to side shifting. Made from 300 and 400 series surgical grade Stainless steel. Will not chip or contaminate other instrumentation. Adjustment screw for easy control of jaw opening. One-Handed, quick release self-locking lever. Available in three sizes.

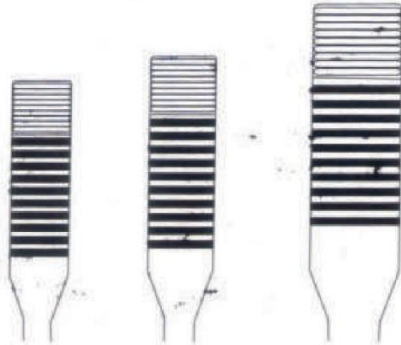

Small Locking pliers
Jo-21-1002
 17.5 cm, 6 7/8"
 tip width 7 mm
 maximum opening 1"

Medium Locking Pliers
Jo-21-1003
 20 cm, 8"
 tip width 9 mm
 maximum opening 1"

Large Locking Pliers
Jo-21-1004
 25.5 cm, 10"
 tip width 13 mm
 maximum opening 1"

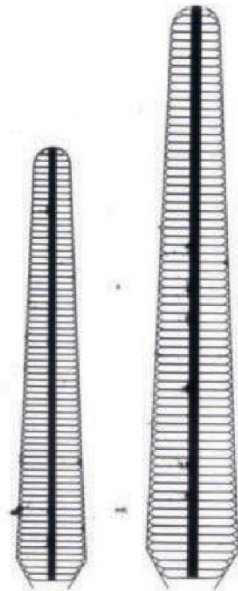

Large Needle Nose Locking Pliers
Jo-21-1006
 30 cm, 12"
 Length of jaw 3"
 tip width 7 mm
 jaws are parallel at 5 mm



Needle Nose Locking Pliers
Jo-21-1005
 24 cm, 9 1/2"
 length of jaw 2 1/2"
 tip width 5 mm
 jaws are parallel at 3 mm



JT-21-970
15 cm / 6"



JT-21-971
20 cm / 8"



JT-21-972 18 cm / 7"
JT-21-972 20 cm / 8"



JT-21-973
 Holding forceps for cerclage wire with lateral jaws to avoid wire slipping off
 17 cm / 6 3/4"



JT-21-974
 Wire tightening pliers
 Signature pliers
 15 cm / 6"



Baumgartner
JT-21-975
 Wire twister, Ligature forceps
 20 cm / 8"



JT-21-976 **JT-21-977** **JT-21-978**

18 cm / 7"

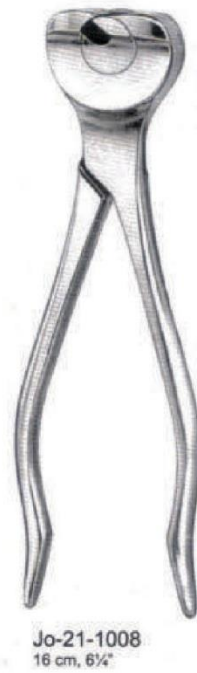
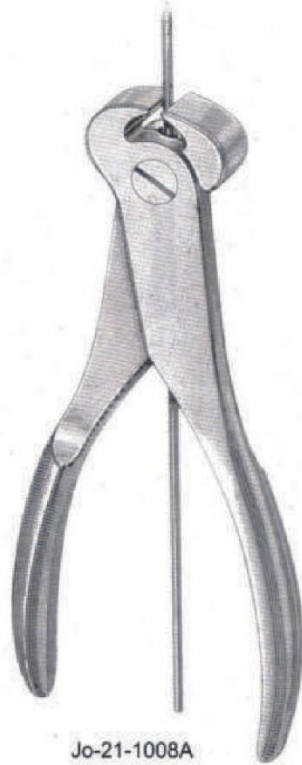



Jo-21-1018
 47 cm, 18 1/2"
 Cutter for Cutting off Kirschner Wires,
 bolts, Tibia head screw,
 Pins up to 6 mm diameter.



Cutter for Cutting off
 Kirschner Wires,
 Tibia head Screws, bolts & Pins
 up to 4 mm diam.



New pattern with three holes
 Cuts three wires at once
 2 mm
 3 mm
 4 mm

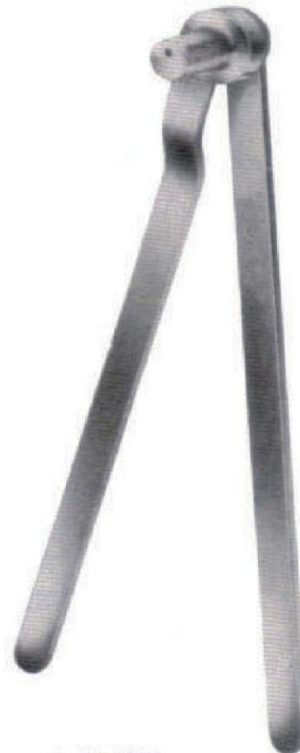

Jo-21-1017
 32 cm, 12 3/4"

for Soft Wire up to diameter	4.0 mm
for hard Wire up to diameter	4.0 mm

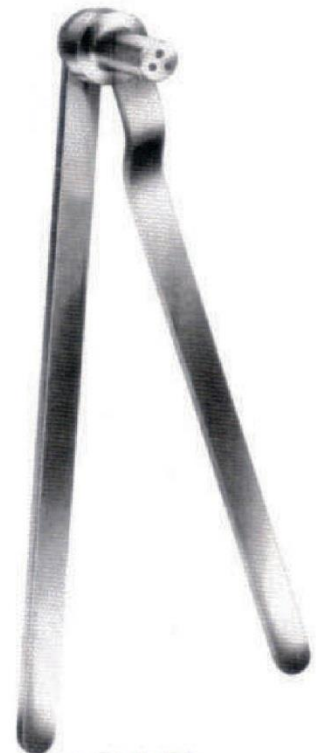

Jo-21-1017 C
 32 cm, 12 3/4"
 Cut three wires at once

for Soft Wire up to diameter	4.0 mm
for hard Wire up to diameter	4.0 mm

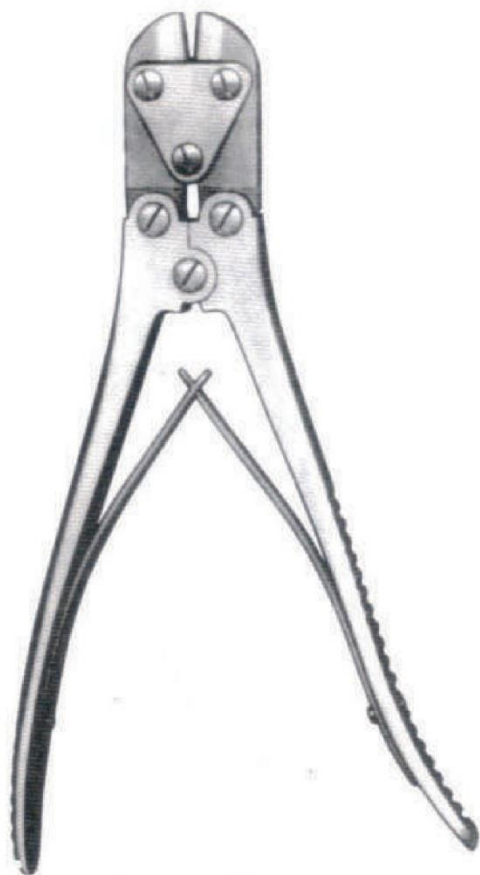
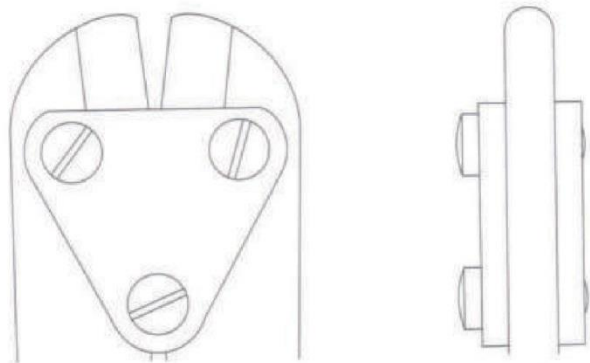
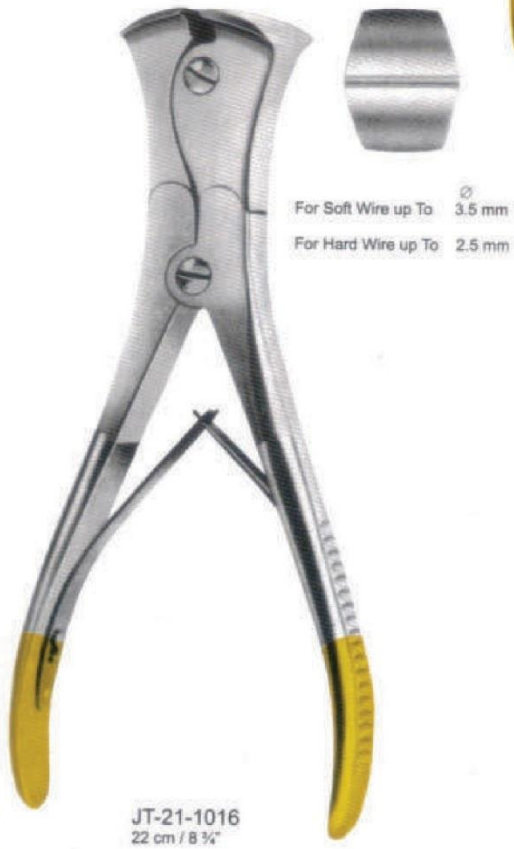
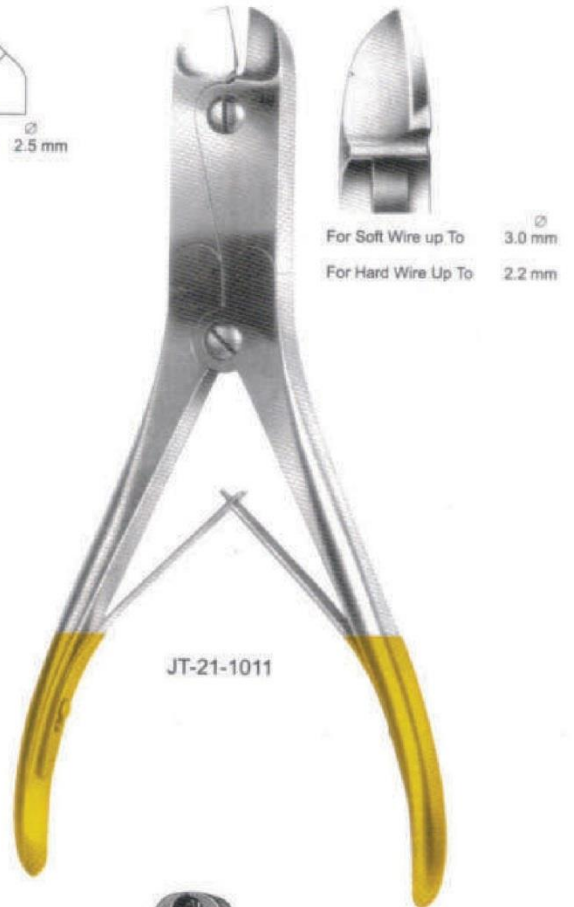

Plate Cutting Forcep
 Jo-21-1019
 24 cm, 9½"
 for cutting stainless steel
 mini plates up to 1 mm

- Also available in TC-Gold



Jo 21-1020
 38 cm, 15"
 Surgicon Double Action pin cutter,
 Heavy Duty with Carb-N-Sert cutting
 Blades, will cut up to ⅜"
 Diameter, stainless





- Jo-21-1035 27.5 cm, 10 1/2"
- Jo-21-1036 28.5 cm, 11 1/4"
- Jo-21-1037 30.5 cm, 12"

Demel
Wire guides

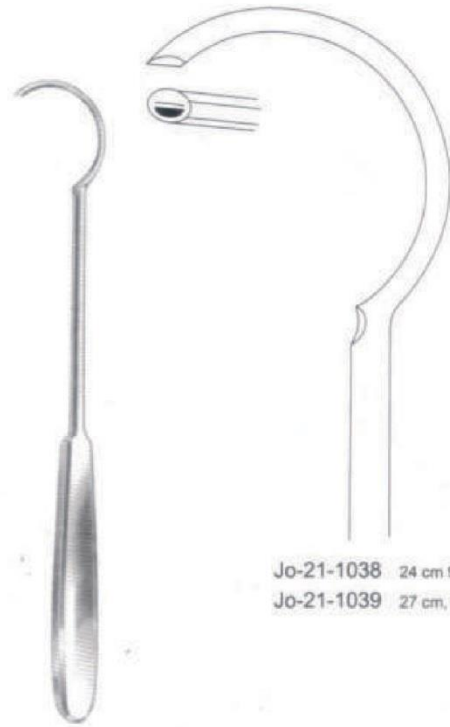

- Jo-21-1038 24 cm 9 1/2"
- Jo-21-1039 27 cm, 10 3/4"

All sizes could be made according to custom specification



Jo-21-1040
22.5 cm, 9"

- Jo-21-1116 XS X-Small curved graft passer
- Jo-21-1117 S Small curved graft passer
- Jo-21-1118 Large curved graft passer
- Jo-21-1119 L X-Large curved graft passer
- Jo-21-1120 XL XX-Large curved graft passer



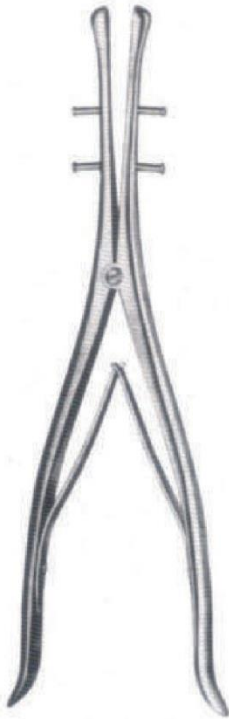
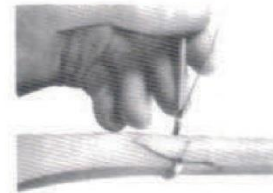
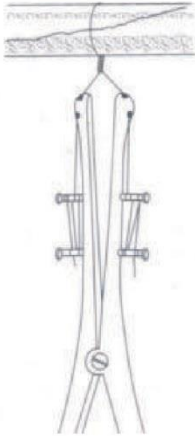

Demel
Jo-21-1041
28 cm / 11"



Loute
Jo-21-1042
21 cm / 8 1/2"



Jo--21-1105
Cerclage wire passer



Jo-21-1124
Plate Benders



Jo-21-1125
Plate Benders



Jo-21-1126
Plate Benders

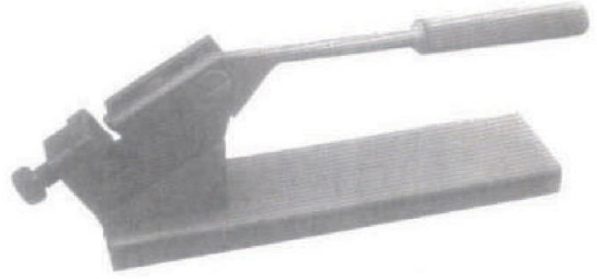

Jo-21-1138
Large Bone Plate Press



Jo-21-1122
Plate Bending Plier



Jo-21-1123
Plate Bending Plier



Front Leg		Hind Leg	
Jo-21-1109	Small	Jo-21-1112	X-small
Jo-21-1110	Medium	Jo-21-1113	Small
Jo-21-1111	Large	Jo-21-1114	Medium
		Jo-21-1115	Large