

Surgical Instruments



Table Of Contents

















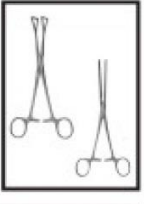
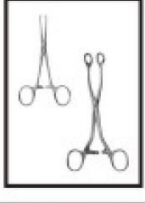
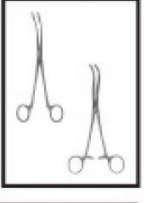

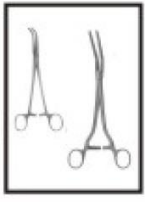

Diagnostic, Anaesthesia and other instruments	Page Seite		Probes, Pocket Instruments sets	Page Seite	
	1 - 8			52 - 54	
Scalpels, knives and Scalpel Handles	9 - 12		Wound Retractors	55 - 65	
Scissors	13 - 29		Self-Retaining Retractors, Abdominal Retractors	66 - 70	
Dissecting-and Tissue Forceps	30 - 36		Abdominal Surgery Intestinal-and Rectal Instruments	71 - 78	
Sponge, Dressing and Tissue Grasping Forceps Towel Clamps	37 - 40		Gall Bladder-, Liver-and Spleen Instruments	79 - 81	
Vessel Clips, Bulldog Clamps Haemostatic Forceps	41 - 44		Genito-Urinary Instruments and Trocars	82 - 85	
Ligature, Hysterectomy and Compression Forceps Vaginal Clamps	45 - 47		Vaginal Specula and Uterine Dilators	86 - 91	
Needle Holders, Suture Instruments	48 - 51		Uterine Probes, Uterine Dressing-, Polypus-and Ovum Forceps	92 - 94	

Table Of Contents

Biopsy Instruments and Curettes	Page Seite		Suction Instruments	Page Seite	
	95 - 98			128 - 129	
Obstetrics and Tracheotomy	99 - 101				
Cardiovascular-and Thoracic Surgery	102 - 110				
Bone Punches, Rongeurs	111 - 112				
Elevators, Bone Levers, Raspatories, Bone Files, Bone Curettes	113 - 117				
Mallets, Chisels and Gouges	118 - 119				
Bone Holding Forceps, Bone Rongeurs, Bone Cutting Forceps	120 - 125				
Plaster Instruments	126 - 127				

Percussion Hammers and Aesthesiometers



01-101
TROEMNER
 Size: 245 mm

½



01-102
DEJERINE
 Size: 200 mm

½



01-103
DEJERINE
 with needle
 Size: 210 mm

½



01-104
TAYLOR
 Size: 195 mm

½



01-105
BERLINER
 Size: 200 mm

½

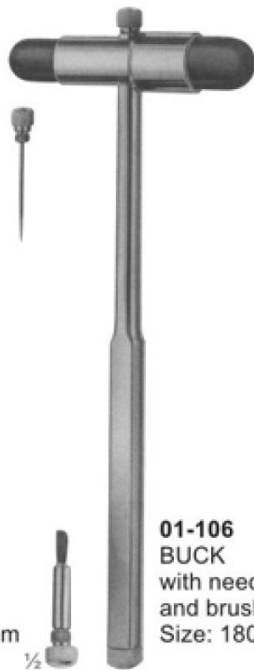

01-106
BUCK
 with needle
 and brush
 Size: 180 mm

½



01-107
RABINER
 with needle
 and brush
 Size: 255 mm

½



01-108
ALY
 Size: 190 mm

½



01-109
WARTENBERG
 Pinwheel for
 neurological
 examination
 Size: 185 mm

½



01-110
PINARD (Aluminum)
Size: 155 mm



01-111
wooden
Size: 145 mm



01-112
BOWLES
Stethoscope
with diaphragm



01-113
ANESTOPHON



01-114
FORD-BOWLES
Dual chest piece
with two outlets



01-115
BOWLES

Head Mirrors and Head Bands

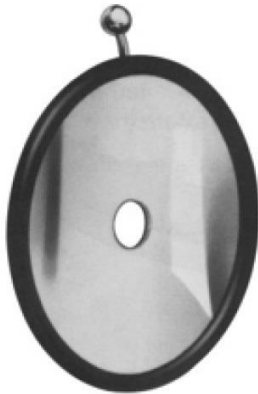

01-116
 ZIEGLER Ø 90mm
 head mirror only
 with rubber coating

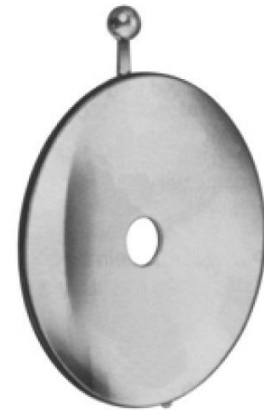

01-117
 ZIEGLER Ø 90mm
 head mirror only
 with metal coating



01-118
 ZIEGLER
 head band of plastic black

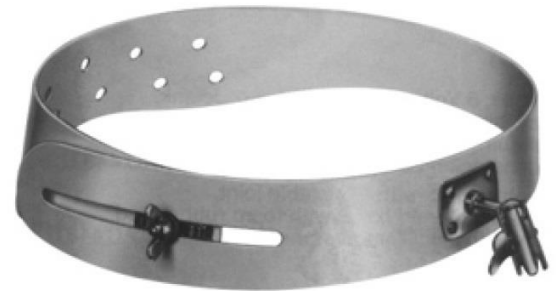

01-120
 MURPHY
 head band of celluloid, white

01-119
 ZIEGLER
 head band of plastic white

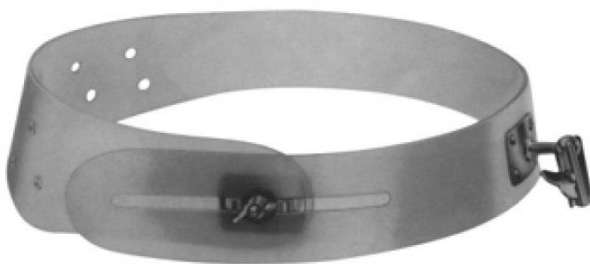

01-121
 head band of plastic,
 white, soft pattern



01-122
 head mirror with black
 plastic head band.

Tongue Depressors

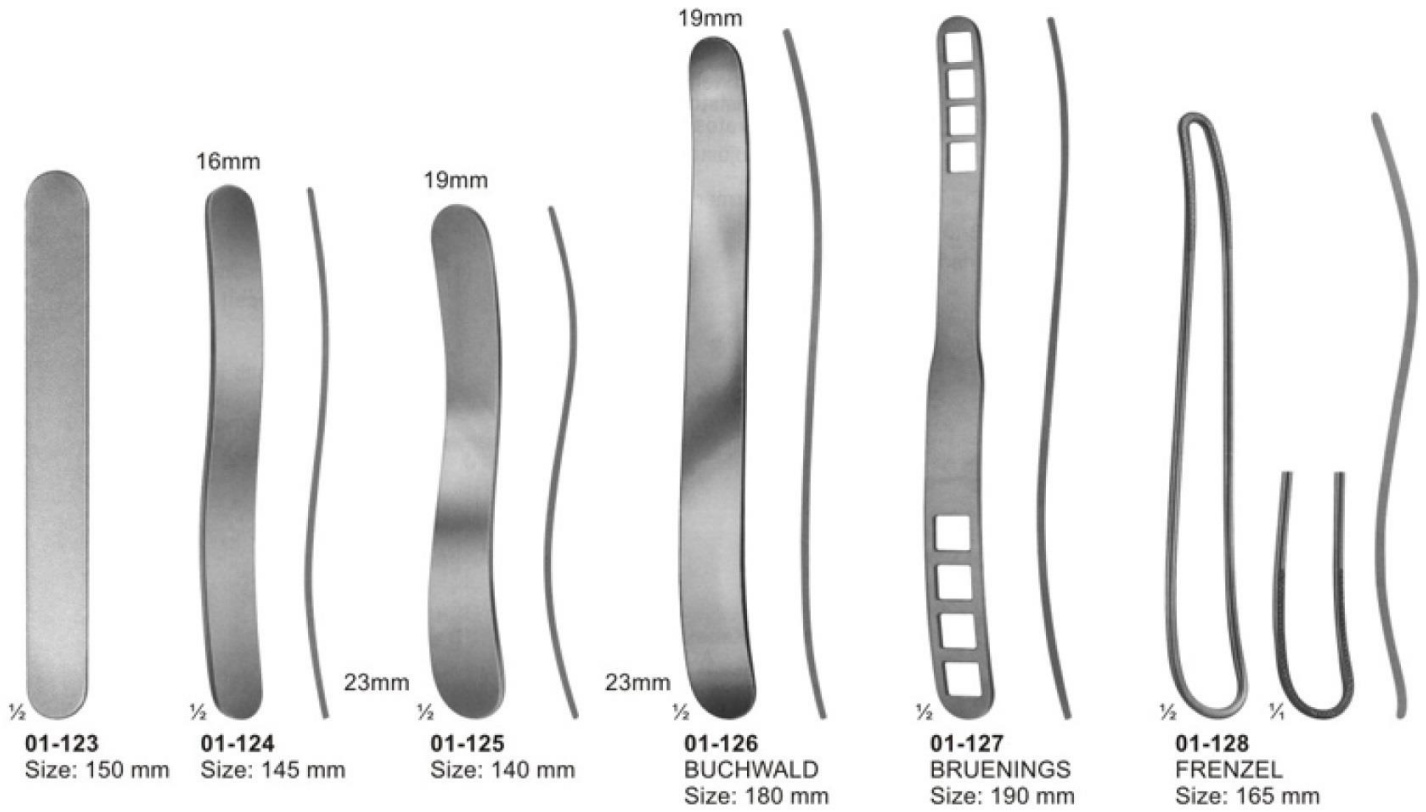

Instruments for Anaesthesia and Tongue Forceps



½
01-134
SCHIMMELBUSCH
 Ether mask



½
01-135
HEISTER
 Mouth gag
 Size: 130 mm



½
01-136
FERGUSSON-ACKLAND
 Mouth gag
 Size: 145 mm



½
01-137
DENHARDT
 Mouth gag with silicon
 inserts, interchangeable
 Size: 125 mm



½
01-138
ROSER KOENIG
 Mouth gag
 Size: 160 mm, 185 mm

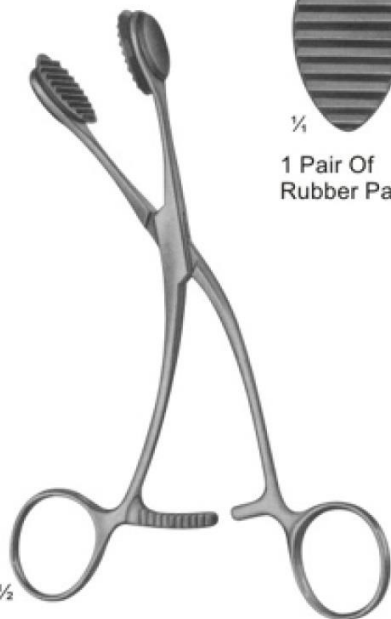

¼
 1 Pair Of
 Rubber Pads

½
01-139
YOUNG
 Size: 165 mm

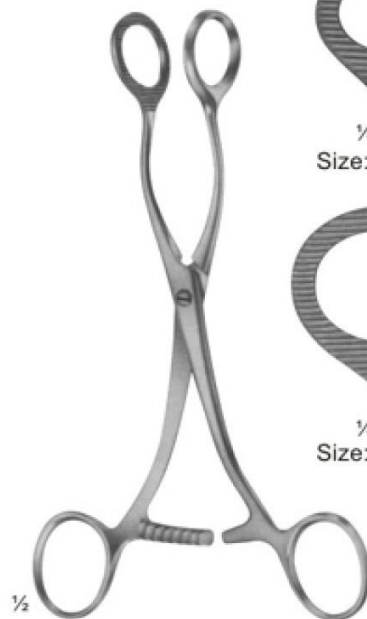

¼
 Size: 160 mm



¼
 Size: 170 mm

½
01-140
COLLIN
 Size: 160 mm, 170 mm

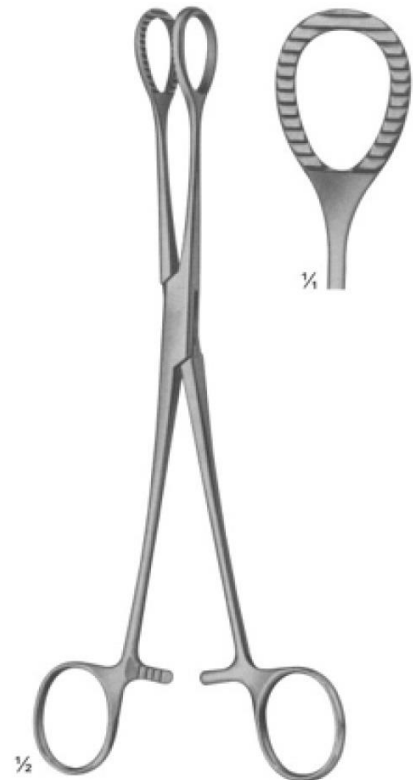

½
01-141
HEYWOOD-SMITH modif.
 Size: 215 mm

Blood Lancets and Laryngeal Mirrors



01-142
FRANCKE
 Automatic blood lancet

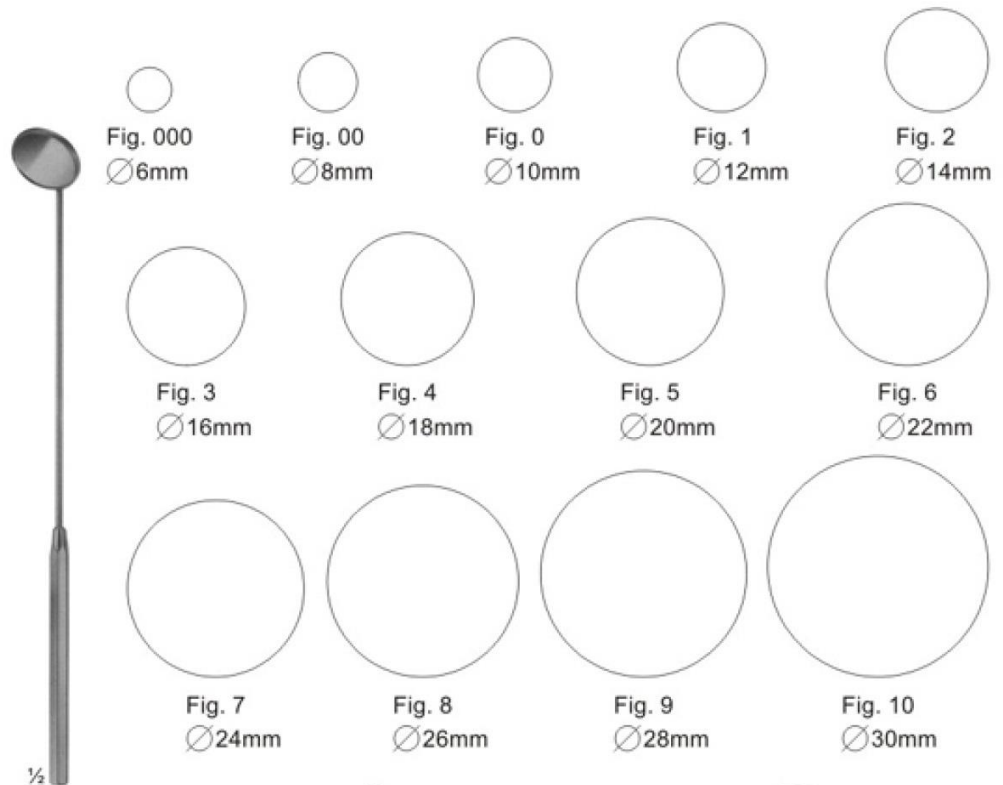

01-143
 Laryngeal mirrors with hexagonal handle
 Size: 180 mm



01-148
 Spare mirrors only
 Size: 12 mm

01-149
 Spare mirrors only
 Size: 14 mm



01-144
KOLLE
 Microscopic Needle
 Holder with plastic handle
 Size: 240 mm



01-145
 Mirror handle
 Size: 110 mm



01-146
 Mirror handle
 Size: 105 mm



01-147
MICHEL
 Rhinoscopic mirrors with
 interchangeable mirror inserts
 Size: 250 mm

Laryngoscope and Diagnostic Sets



½

01-150 - 152
MAGILL



¼

01-150
Infants
Size: 150 mm



¼

01-151
Children
Size: 200 mm



¼

01-152
Adults
Size: 250 mm



½

01-153
Medium battery handle
only, 25 mm diam.



01-153-A
Spare bulb
2.7 volt, for
otoscopes



01-153-B
Spare bulb
2.6 volt, for
ophthalmoscopes



01-154
Otoscope set, consists of
battery handle without batteries,
3 ear specula, 1 bulb in valvet lined case



01-155
Diagnostic set, otoscope with three specula,
nasal speculam, lamp holder, two laryngeal
mirrors, tongue blade holder

Laryngoscopes



01-156
MILLER
 Laryngoscope set, consists of battery handle (without battery)
 with four miller laryngoscope blades

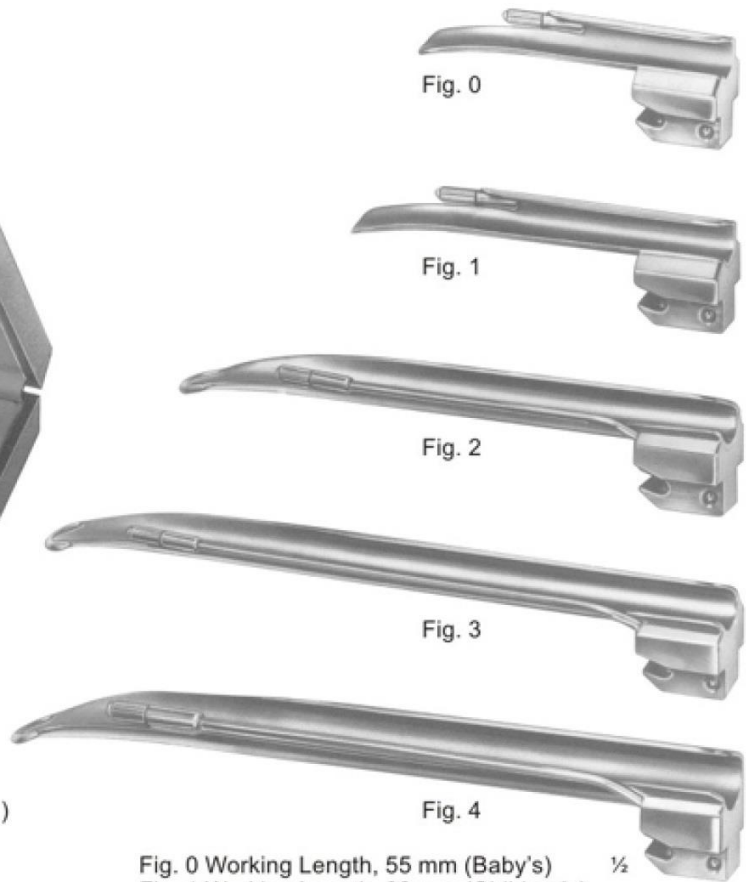

Fig. 0 Working Length, 55 mm (Baby's) $\frac{1}{2}$
 Fig. 1 Working Length, 80 mm (Children's)
 Fig. 2 Working Length, 130 mm (Adolescent's)
 Fig. 3 Working Length, 170 mm (Women's)
 Fig. 4 Working Length, 180 mm (Men's)



01-157
GUEDEL-NEGUS
 Laryngoscope set, consists of battery handle (without battery)
 with four miller laryngoscope blades

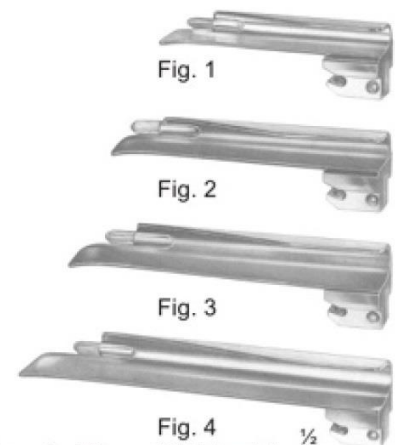

Fig. 1 Working Length, 70 mm (Children's) $\frac{1}{2}$
 Fig. 2 Working Length, 90 mm (Adolescent's)
 Fig. 3 Working Length, 110 mm (Women's)
 Fig. 4 Working Length, 135 mm (Men's)



02-101 - 110
Fig. 1 - 10



02-101
Fig. 1
30 mm



02-102
Fig. 2
36 mm



02-103
Fig. 3
40 mm



02-104
Fig. 4
45 mm



02-105
Fig. 5
50 mm



02-106
Fig. 6
27 mm



02-107
Fig. 7
35 mm



02-108
Fig. 8
40 mm



02-109
Fig. 9
47 mm



02-110
Fig. 10
50 mm



LISTON
02-111
 Size: 130 mm
02-112
 Size: 160 mm
02-113
 Size: 190 mm
02-114
 Size: 200 mm

02-115
CATLIN
 Size: 160 mm
 Blade length
 Amputating
 Knives

02-116
LANGENBECK
 Size: 120 mm
 Blade length
 Flap Knives

02-117
 Size: 110 mm
 Blade length
 Interosseous
 Knives

02-118
 Size: 55 mm
 Blade length
 with raspatory,
 Wooden handle

02-119
 Size: 70 mm
 Blade length
 Wooden handle

02-120
 Size: 80 mm
 Blade length
 Metal handle

02-121
 Size: 195 mm
 Blade length
 Metal handle

Blade length
 Amputating Knives



02-122
 AYRE
 Size: 235 mm
 Cone Knife

02-123
 Size: 230 mm
 Cone Knife

02-124
 SEGOND
 Size: 270 mm
 Myomatome

02-125
 OLIVECRONA
 Size: 205 mm
 Trigeminal
 Knife

02-126
 Size: 230 mm
 Trigeminal
 Knife

02-127
 FOWLER
 Size: 200 mm
 Tonsil Knife

02-128
 ABRAHAM
 Size: 215 mm
 Tonsil Knife

02-129
 BRUNINGS
 Size: 215 mm
 Tonsil Knife

Scalpel Handles

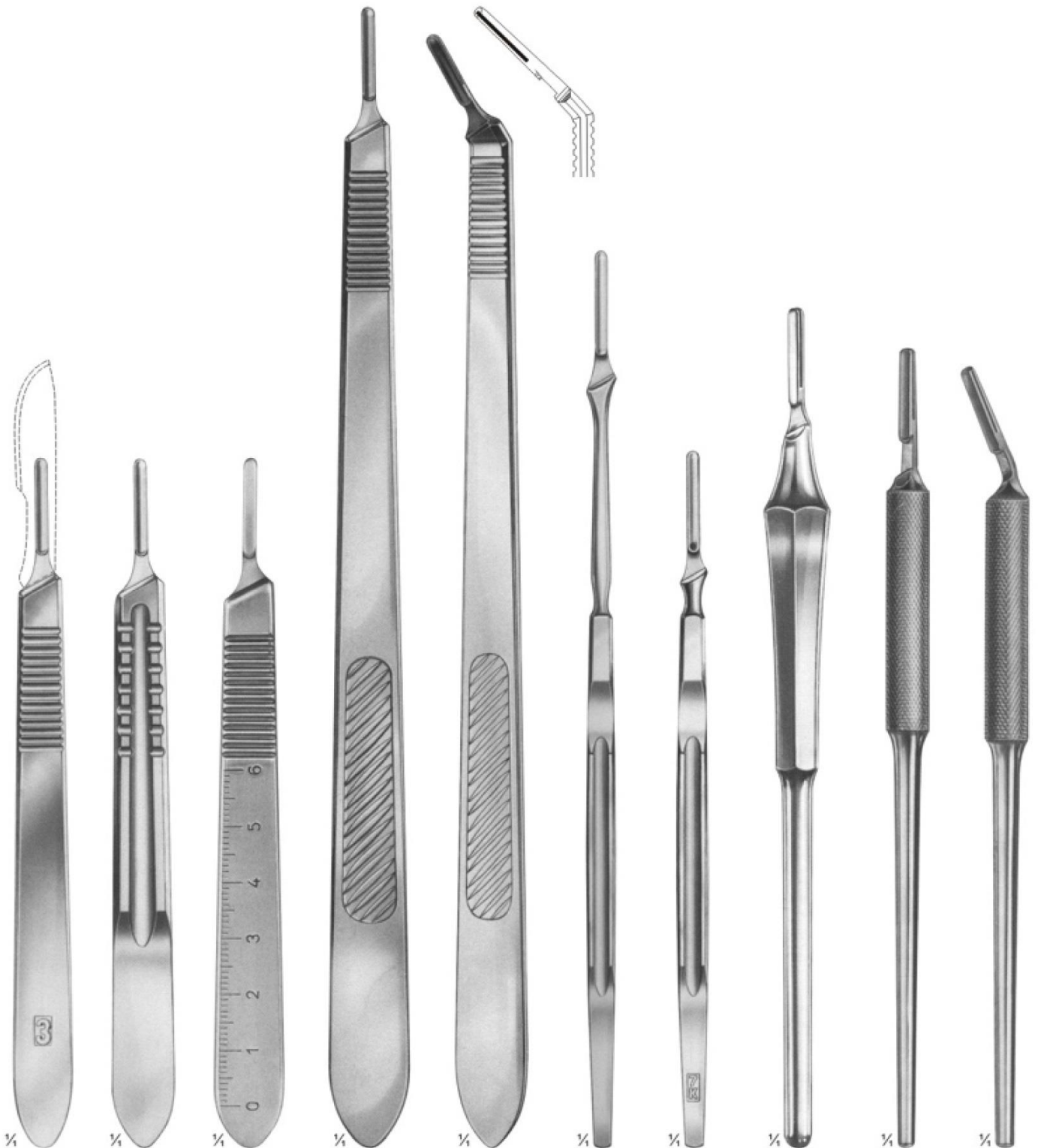

02-130 STANDARD No. 3 Solid 12 cm	02-131 No. 3 Solid 12 cm	02-132 No. 3 Solid 12 cm	02-133 No. 3 L Straight Solid 21.5 cm	02-134 No. 3 L Angled Solid 21 cm	02-135 No. 7 Solid 16 cm	02-136 No. 7 K Solid 12.5 cm	02-137 Hollow-Round 15.5 cm	02-138 No. 3 Straight Solid, Round 14.5 cm	02-139 No. 3 Angled Solid, Round 14 cm
------------------------------------------------------	------------------------------------------	------------------------------------------	----------------------------------------------------------	------------------------------------------------------	------------------------------------------	----------------------------------------------	------------------------------------------	------------------------------------------------------------------	--------------------------------------------------------------

Micro Scissors (Spring Type) with Flat Handles

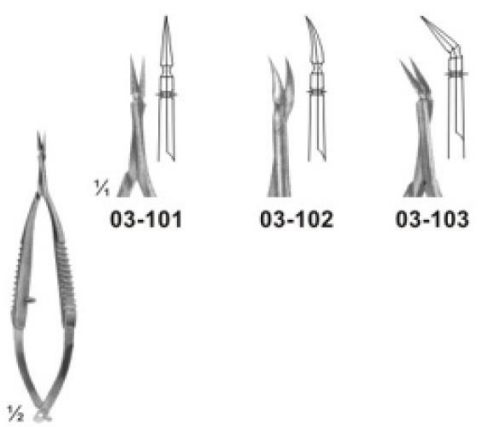

03-101 - 103
VANNAS
 Size: 85 mm



03-104 - 105
CASTROVIEJO
 Size: 95 mm

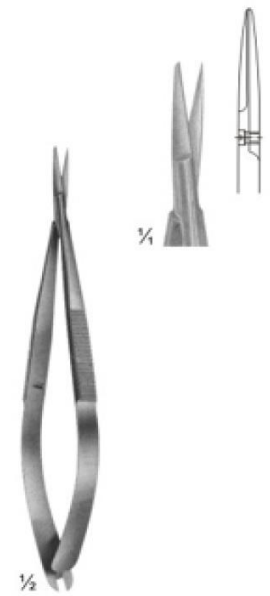

03-106
NOYES
 Size: 125 mm

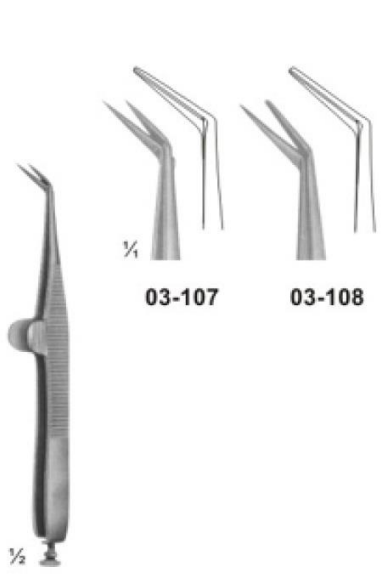

03-107 - 108
WECKER
 Eye scissor
 Size: 110 mm

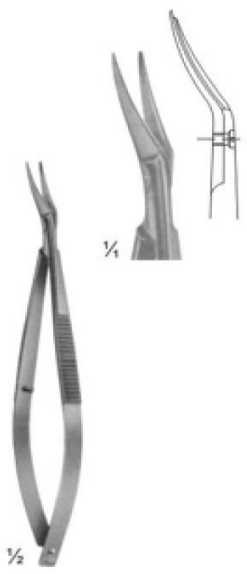

03-109
CASTROVIEJO
 Eye scissor
 Size: 115 mm

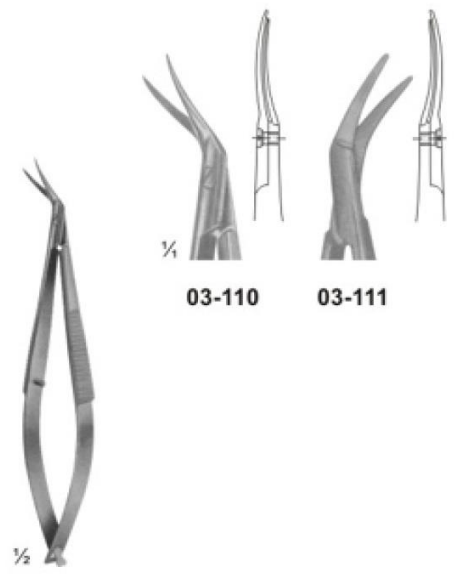

03-110 - 111
CASTROVIEJO
 Eye scissor
 Size: 110 mm

Micro Scissors (Spring Type) with Flat Handles

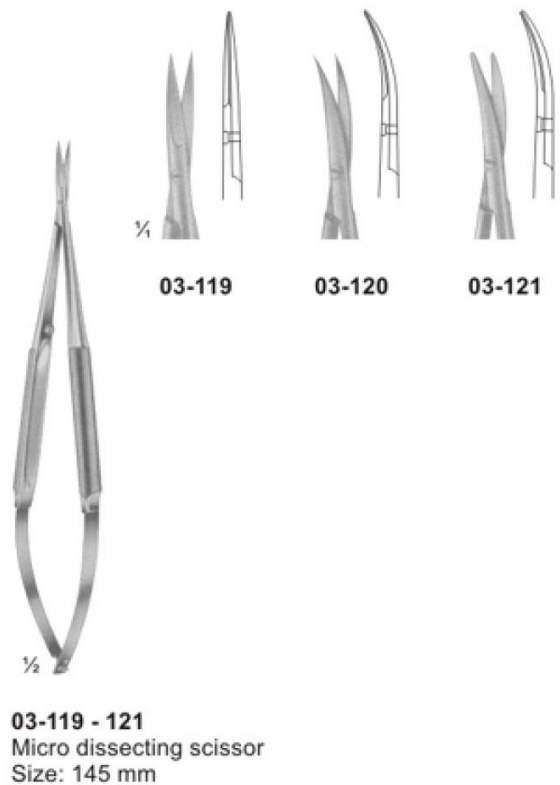
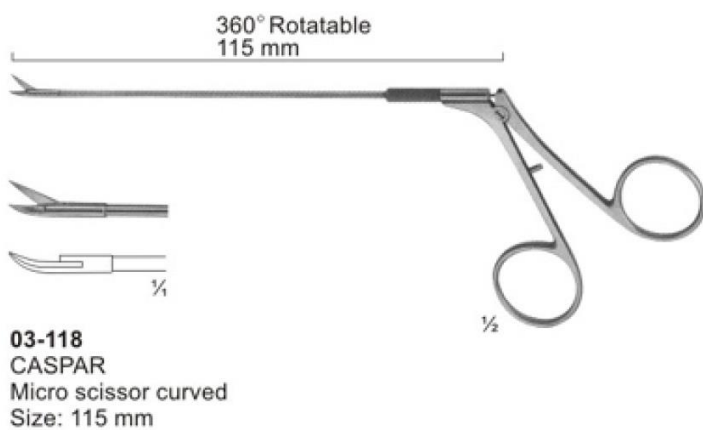
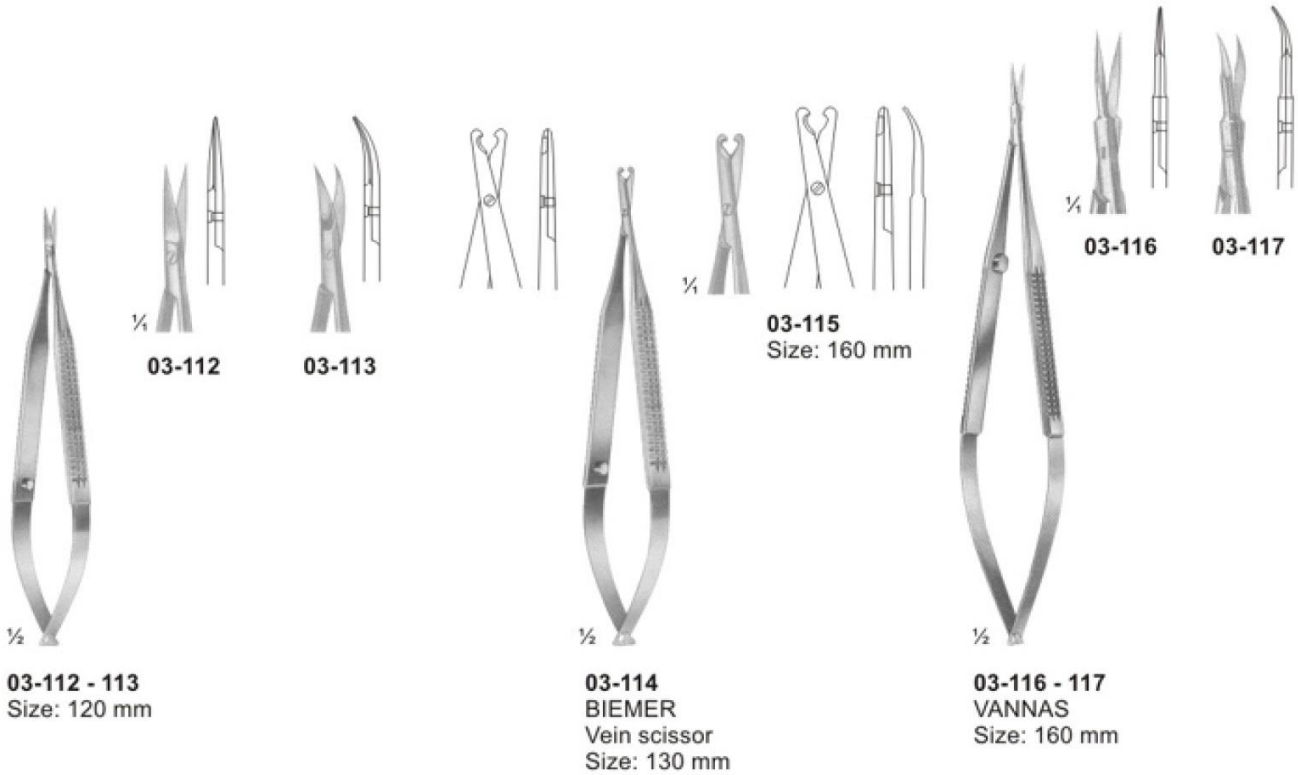

Micro Scissors (Spring Type) bayonet-Shaped



03-122
YASARGIL
 Size: 245 mm



03-123
 45°



03-124
 45°



03-125
 laterally angled
 Size: 190 mm

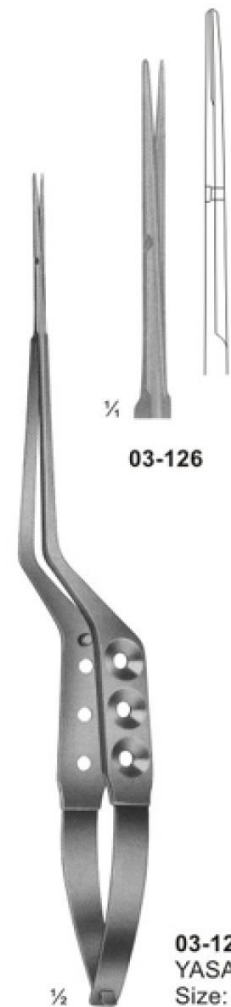

03-126

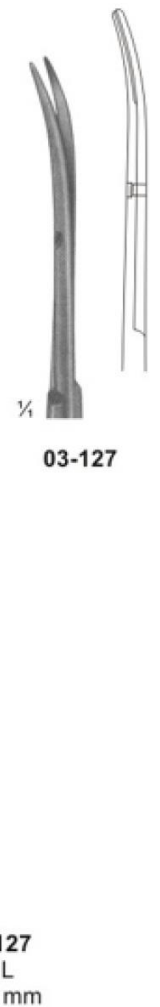

03-127

03-126 - 127
YASARGIL
 Size: 225 mm

Delicate Scissors

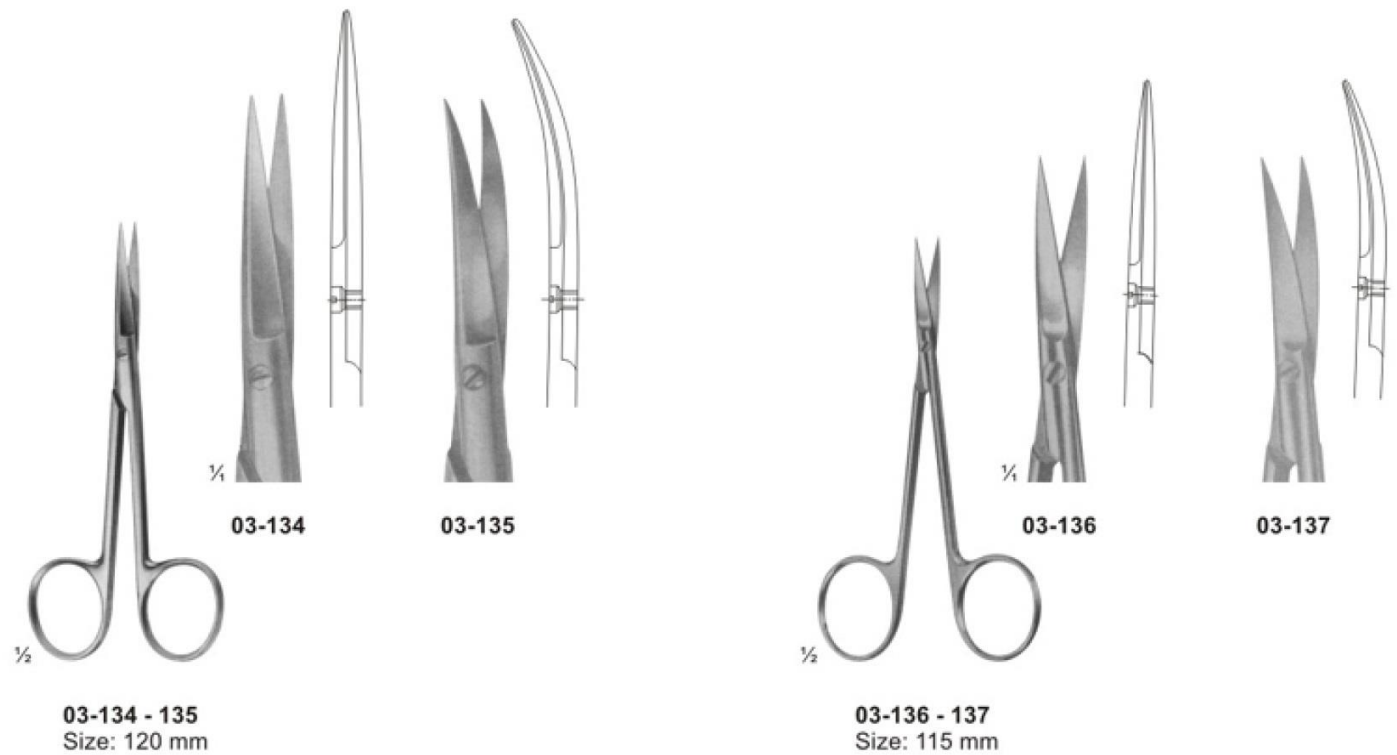
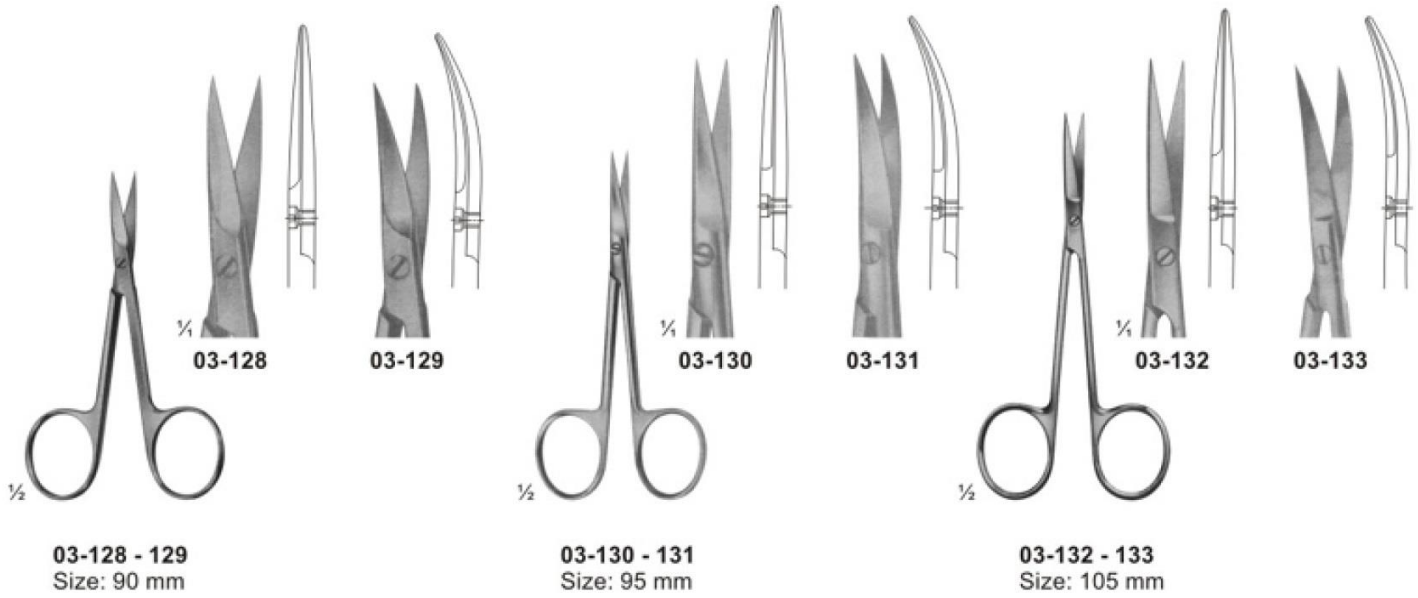

Delicate Scissors



03-138 - 140
 Size: 120 mm

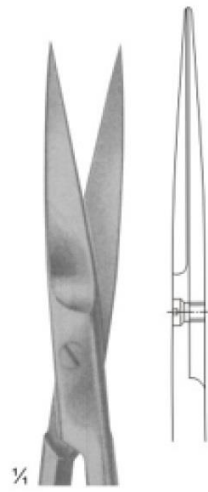

03-138

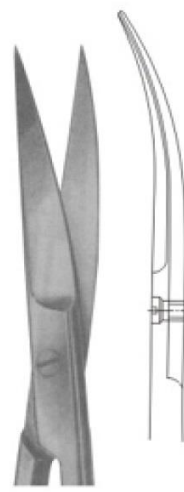

03-139

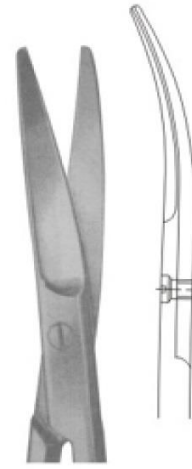

03-140



03-141 - 144
 Size: 130 mm

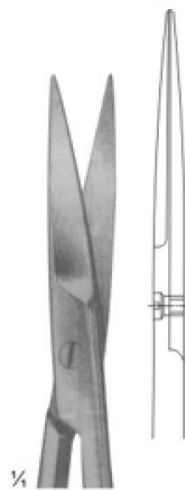

03-141

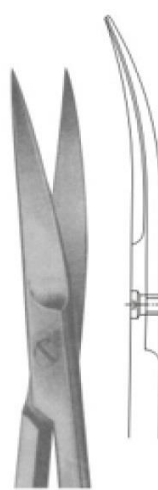

03-142

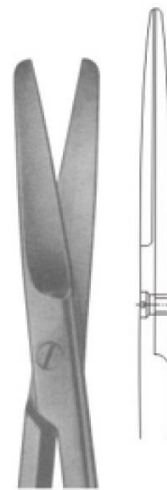

03-143

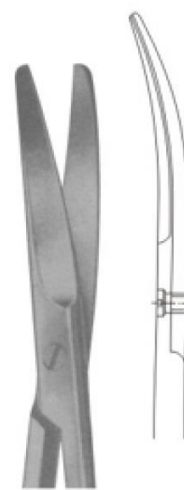

03-144

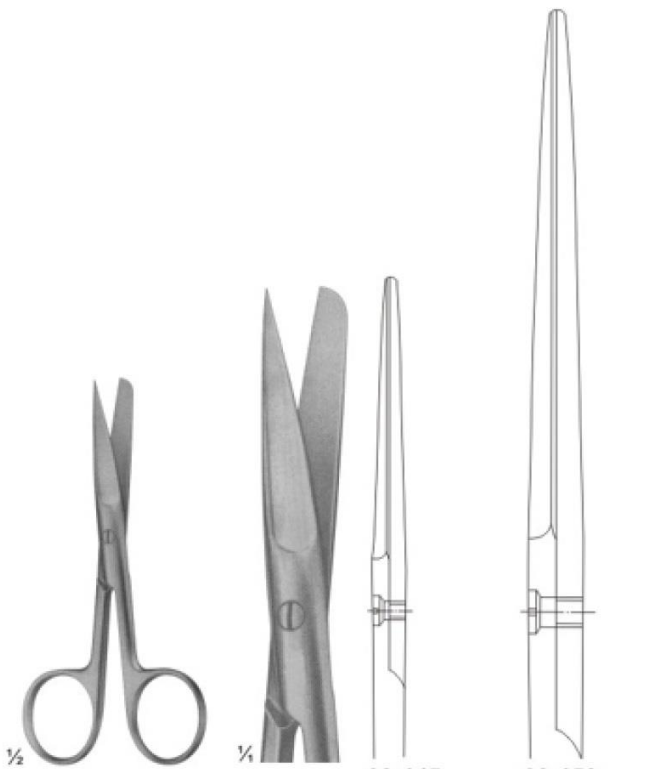

03-145 - 153 (Standard types)
 03-145 (105 mm)
 03-146 (115 mm)
 03-147 (130 mm)
 03-148 (145 mm)
 03-149 (150 mm)
 03-150 (165 mm)
 03-151 (175 mm)
 03-152 (185 mm)
 03-153 (200 mm)

03-145
 Size: 105 mm

03-153
 Size: 200 mm

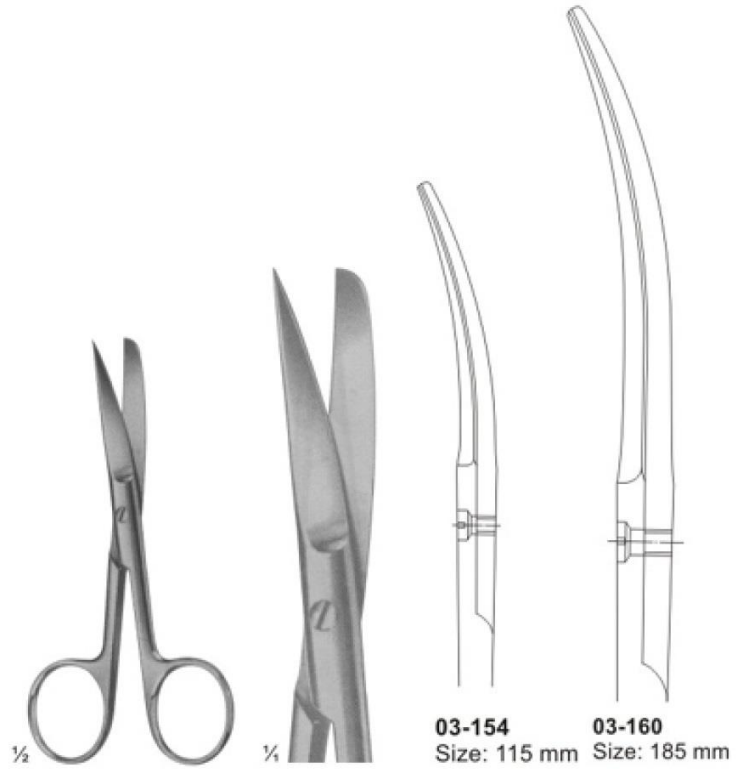

03-154 - 160 (Standard types)
 03-154 (115 mm)
 03-155 (130 mm)
 03-156 (145 mm)
 03-157 (150 mm)
 03-158 (165 mm)
 03-159 (175 mm)
 03-160 (185 mm)

03-154
 Size: 115 mm

03-160
 Size: 185 mm

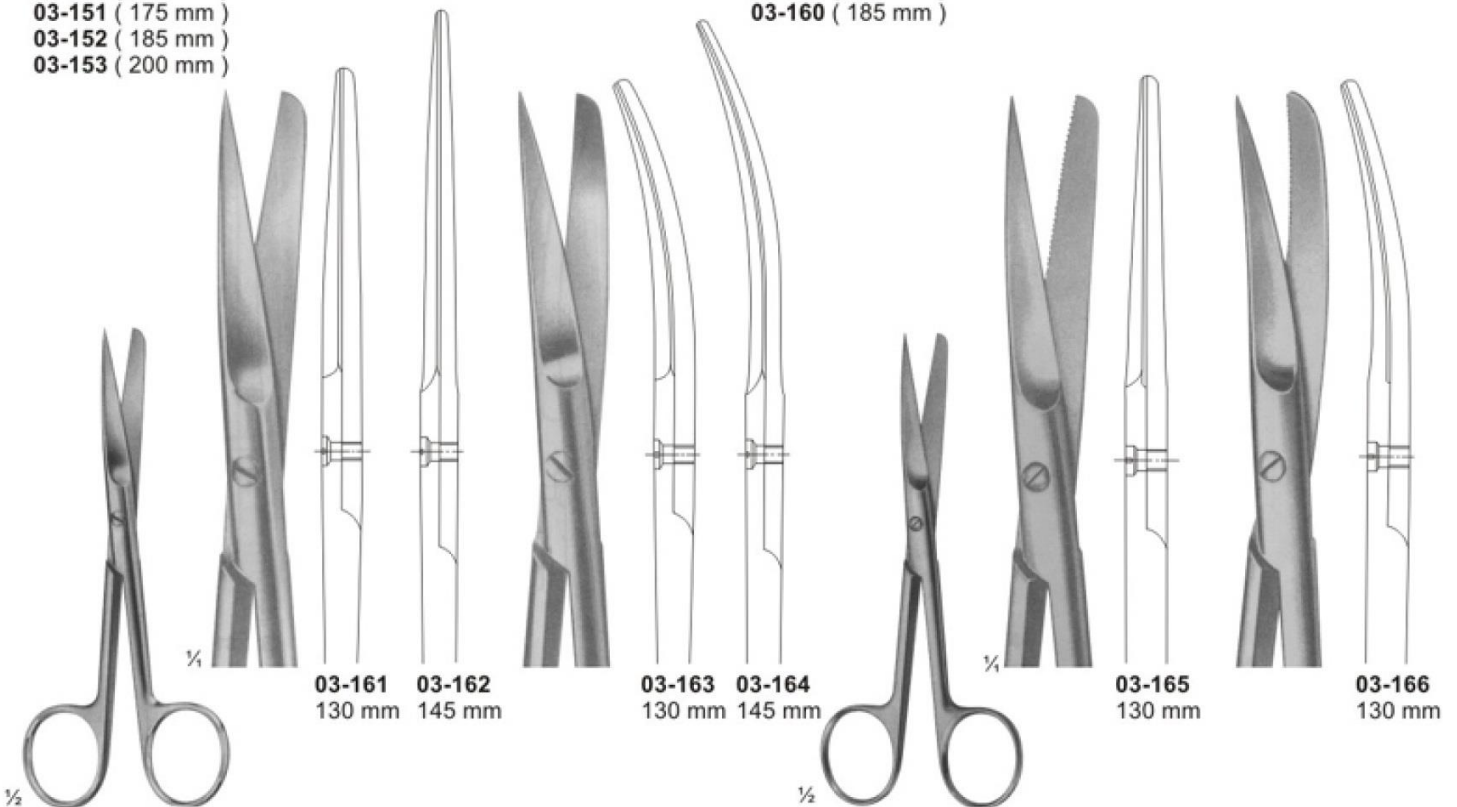

03-161 - 164
 Slender types

03-165 - 166
 for wound edges
 1 blade serrated

Surgical Scissors



1/2

03-167 - 169
DEAVER
 with flat lock

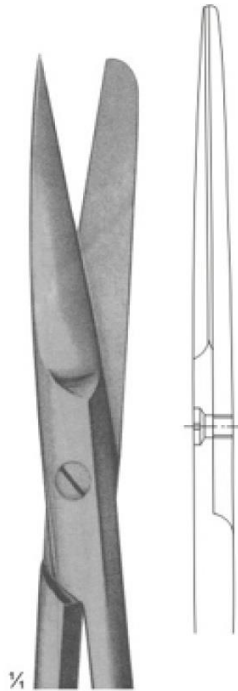

1/4

03-167
 Size: 145 mm

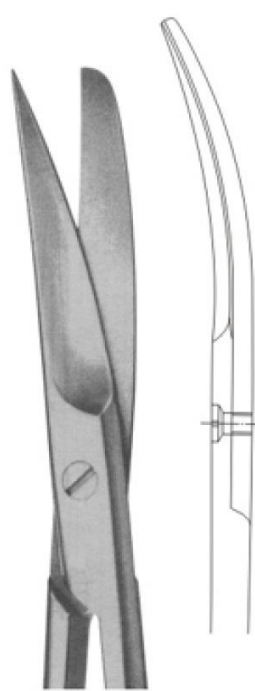

1/4

03-168
 Size: 145 mm

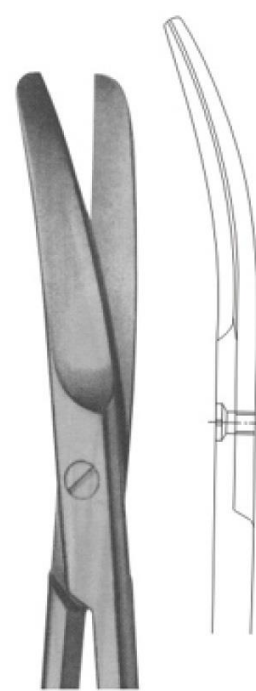

1/4

03-169
 Size: 145 mm



1/2

03-170 - 172
 Incision scissors

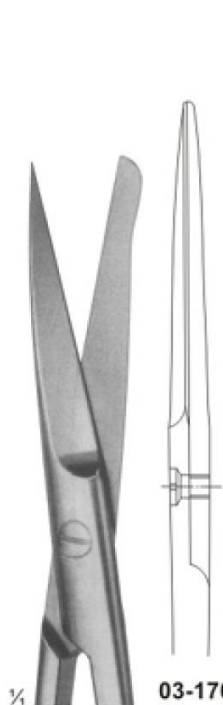

1/4

03-170
 Size: 130 mm



1/4

03-171
 Size: 145 mm

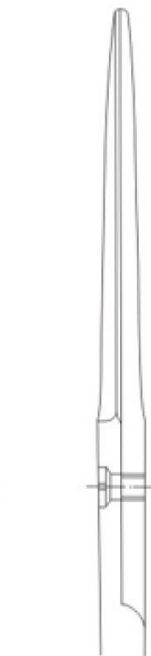

1/4

03-172
 Size: 165 mm

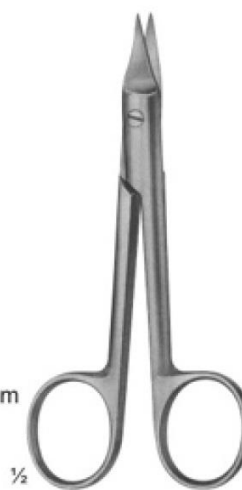

1/2

03-173
SYSTRUNK
 Nail splitting scissors

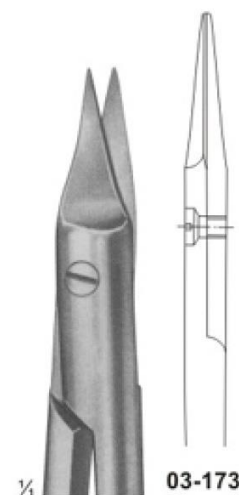

1/4

03-173
 Size: 130 mm

Dissecting Scissors

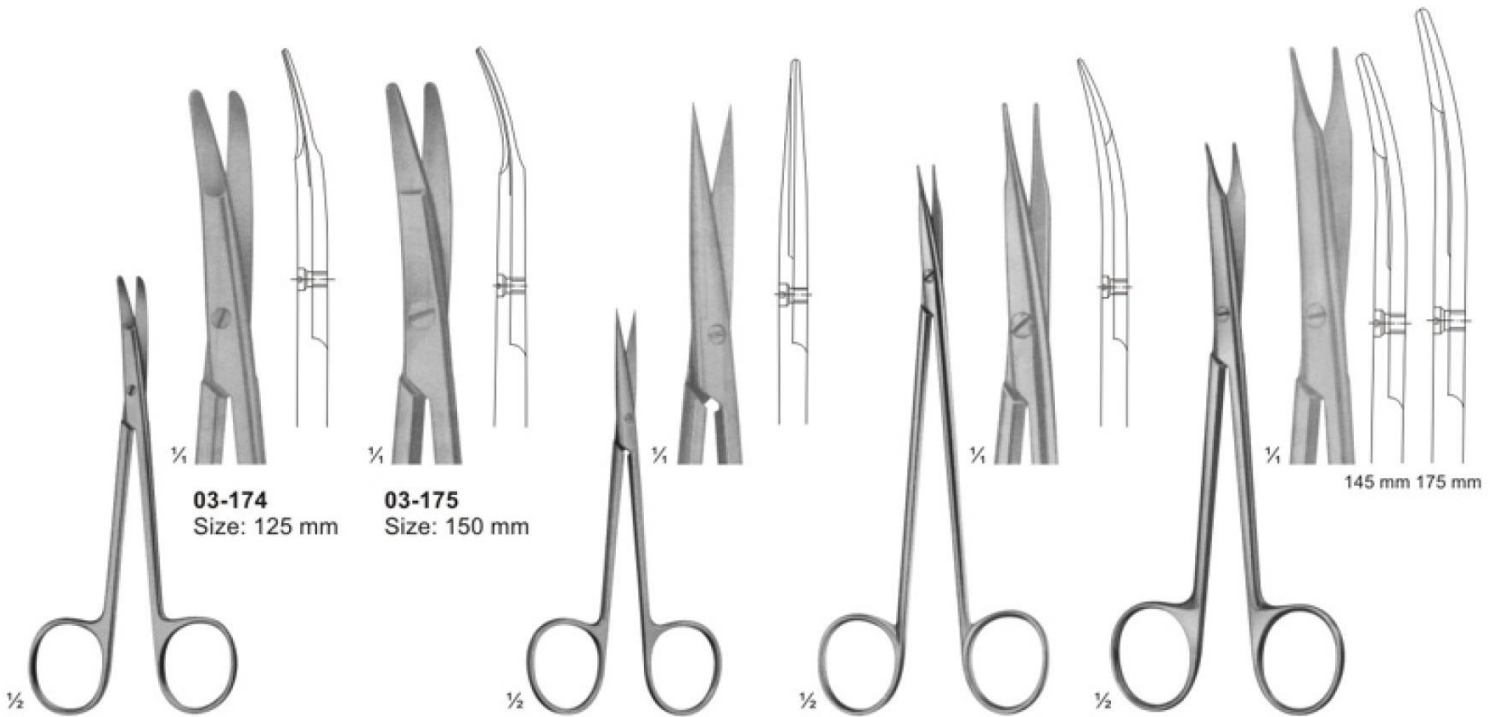

03-174 - 175
KILNER
 Special flat points for dissecting
 and undermining the skin

03-176
KILNER
 Fine dissecting scissors
 Size: 115 mm

03-177
JAMESON
 Dissecting scissors
 Size: 150 mm

03-178
REYNOLDS
 Dissecting scissors
 Size: 145 - 175 mm

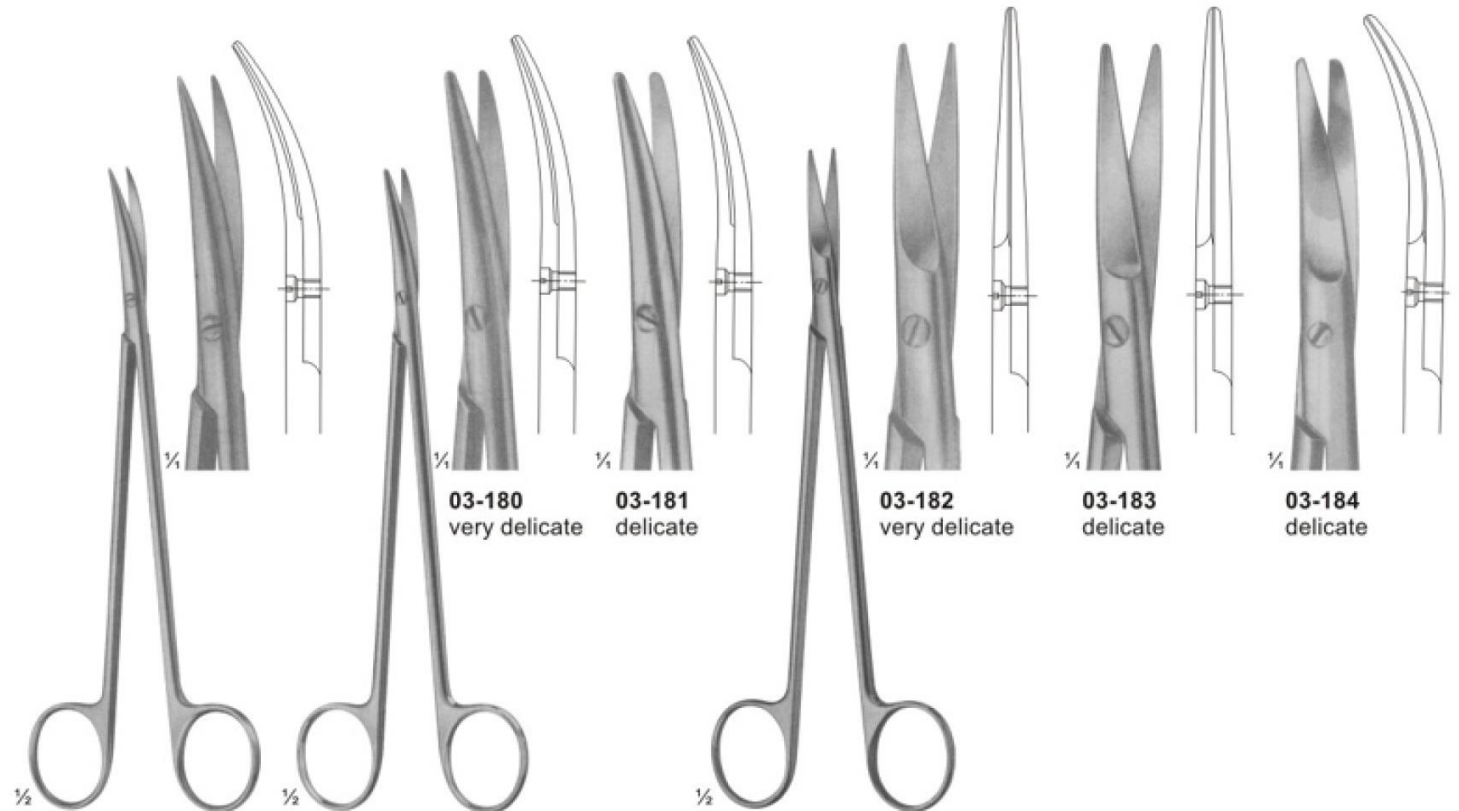

03-179
DE BAKEY
 Arteriotomy scissors
 Size: 175 mm

03-180 - 181
TOENNIS ADSON
 Dissecting scissors
 Size: 175 mm

03-182 - 184
TOENNIS
 Dissecting scissors
 Size: 180 mm

Dissecting Scissors

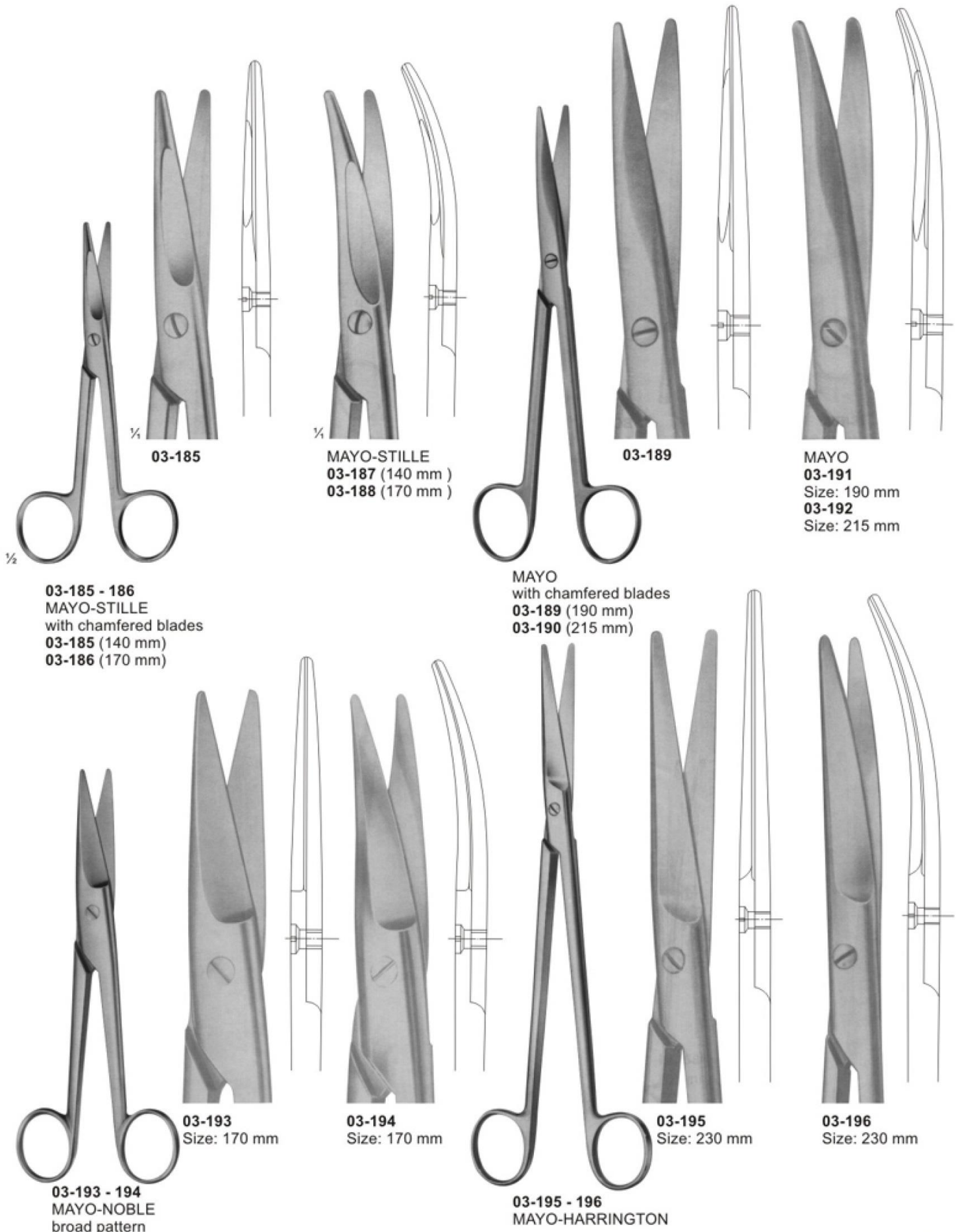

03-185

MAYO-STILLE
03-187 (140 mm)
03-188 (170 mm)

03-189

MAYO
03-191
 Size: 190 mm
03-192
 Size: 215 mm

03-185 - 186
MAYO-STILLE
 with chamfered blades
03-185 (140 mm)
03-186 (170 mm)

MAYO
 with chamfered blades
03-189 (190 mm)
03-190 (215 mm)

03-193
 Size: 170 mm

03-194
 Size: 170 mm

03-195
 Size: 230 mm

03-196
 Size: 230 mm

03-193 - 194
MAYO-NOBLE
 broad pattern

03-195 - 196
MAYO-HARRINGTON

Scissors for Cardiovascular and Neuro-Surgery



03-207
OLIVECRONA
 Dura scissors

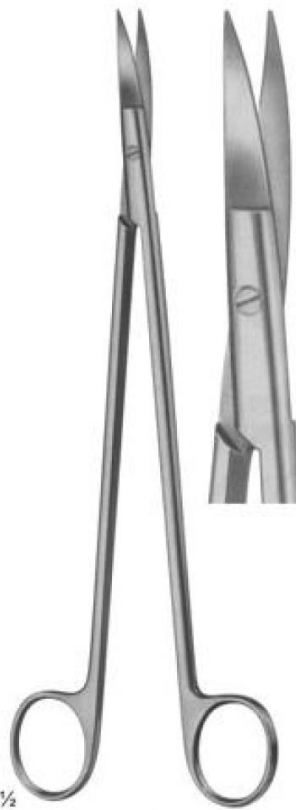

03-208
STRULLY
 pointed
 Size: 220 mm

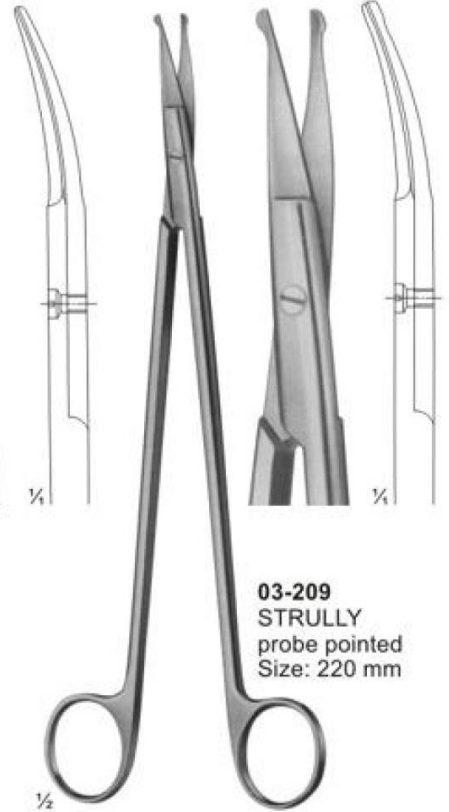

03-209
STRULLY
 probe pointed
 Size: 220 mm

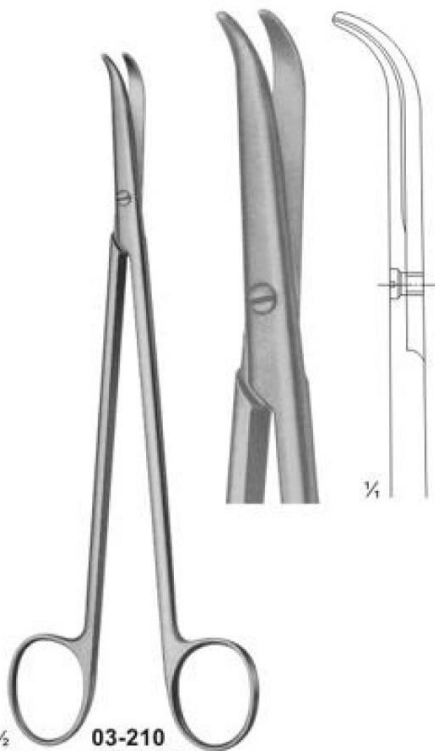

03-210
THOREK
 Size: 180 mm

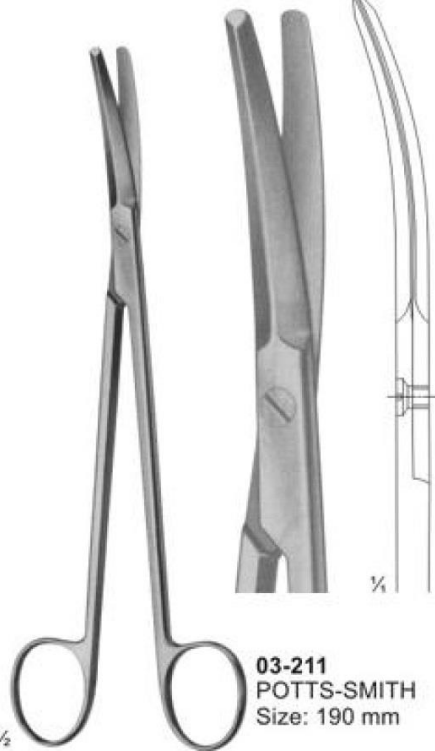

03-211
POTTS-SMITH
 Size: 190 mm

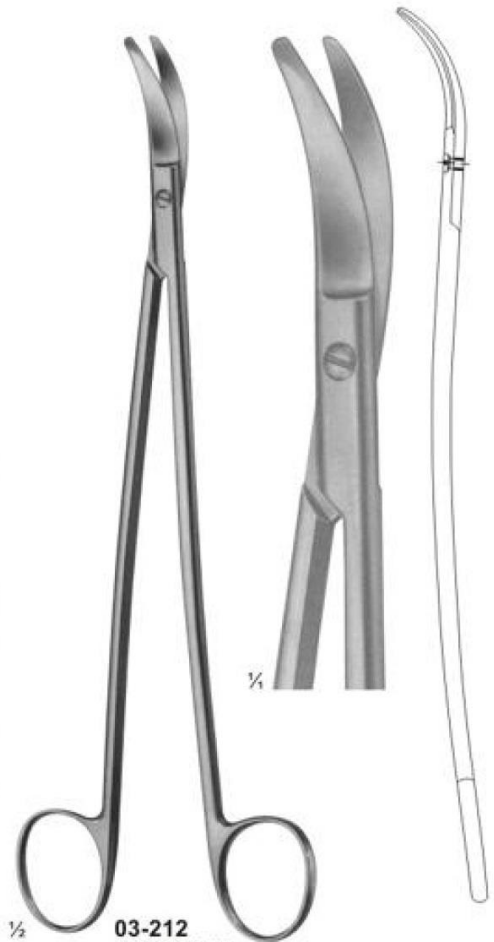

03-212
SATINSKY
 Size: 245 mm

Delicate, Nasal and Tonsil Scissors

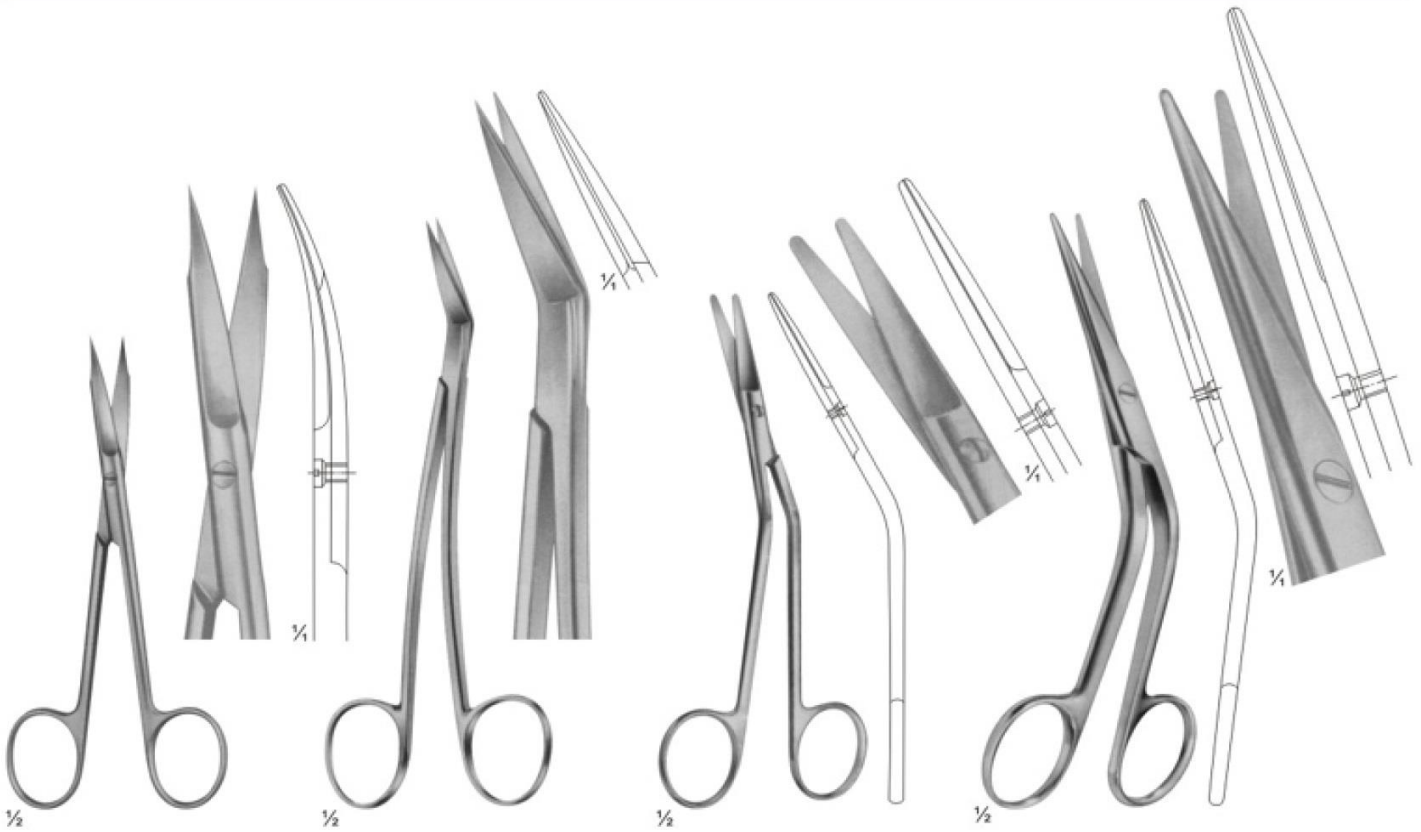

03-213
 1 finely toothed blade
 Size: 130 mm

03-214
 LOCKLIN
 curved sideways,
 1 toothed blade
 Size: 155 mm

03-215
 FOMON
 blades serrated
 Size: 145 mm

03-216
 COTTLE
 Size: 165 mm

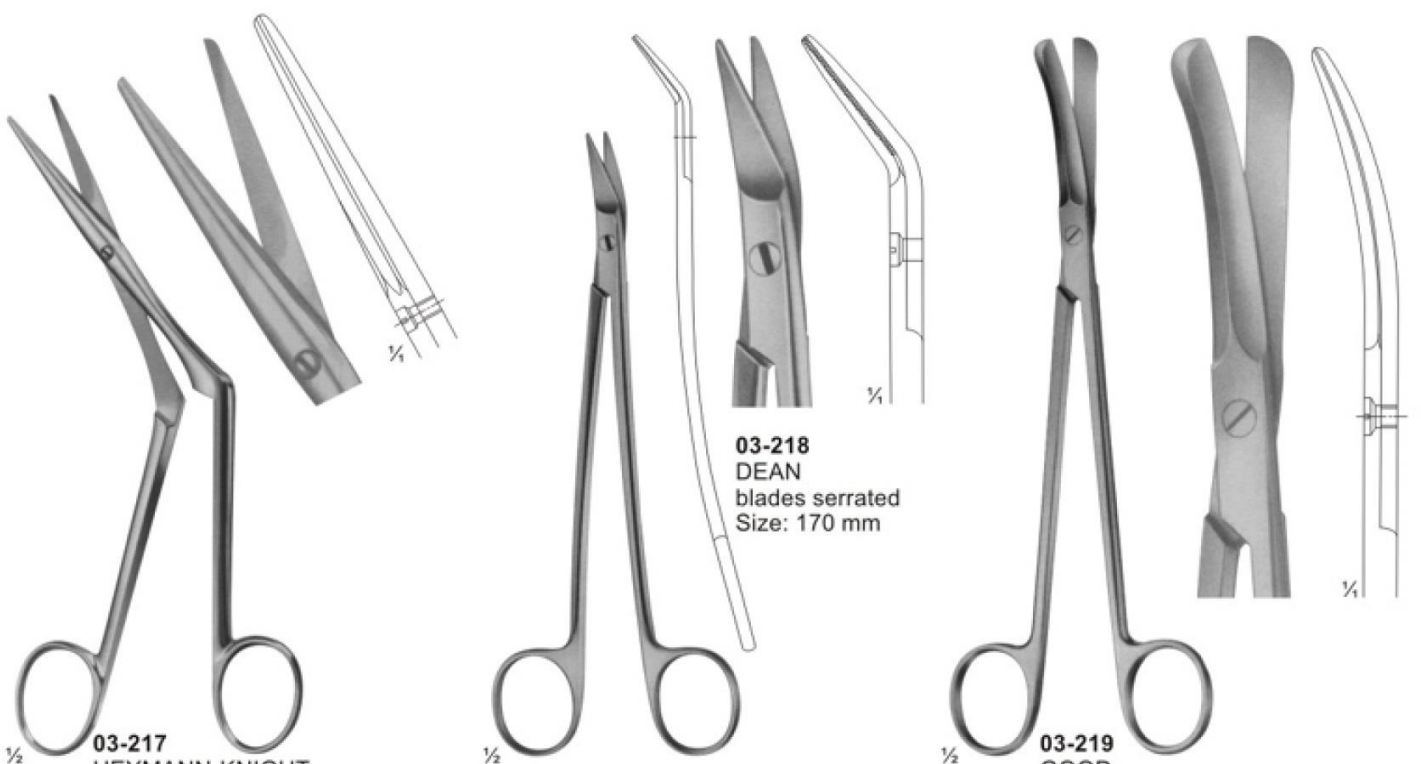

03-217
 HEYMANN-KNIGHT
 Size: 175 mm

03-218
 DEAN
 blades serrated
 Size: 170 mm

03-219
 GOOD
 Size: 195 mm

Bone Shears

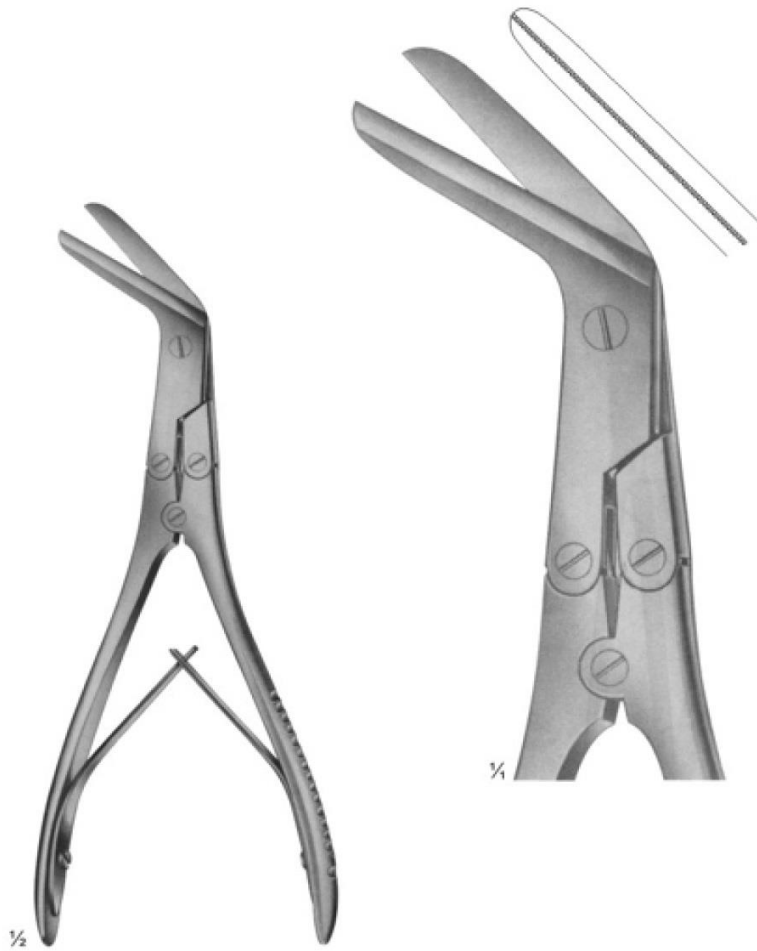

03-220
KILLIAN
Size: 200 mm



03-221 - 222

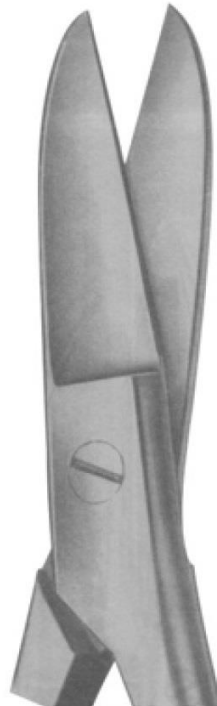

03-221
195 mm

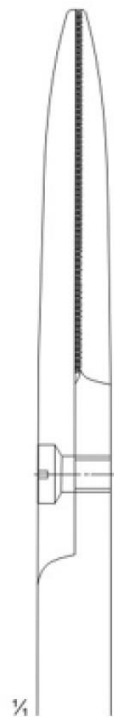

1/4



03-222
225 mm



1/4

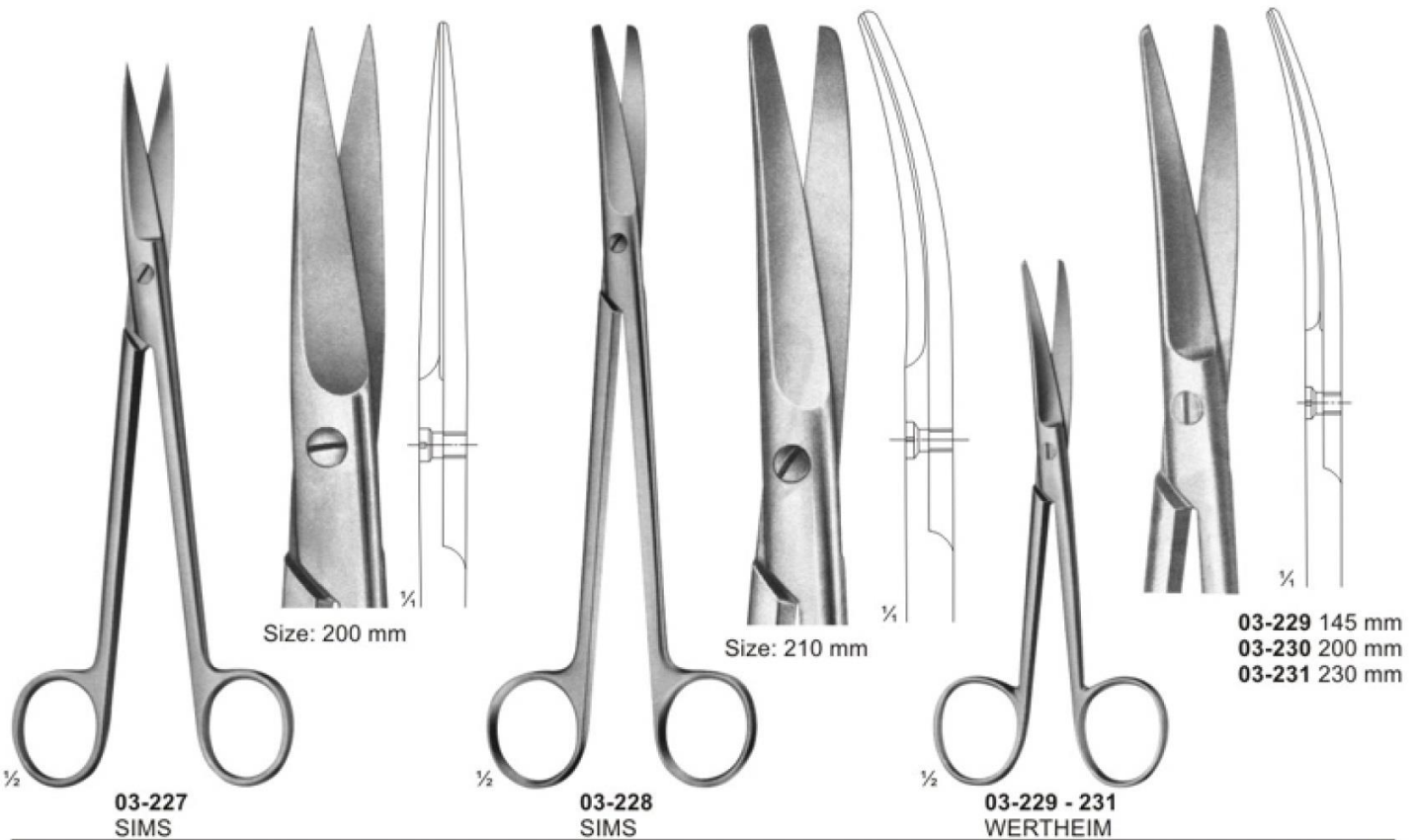
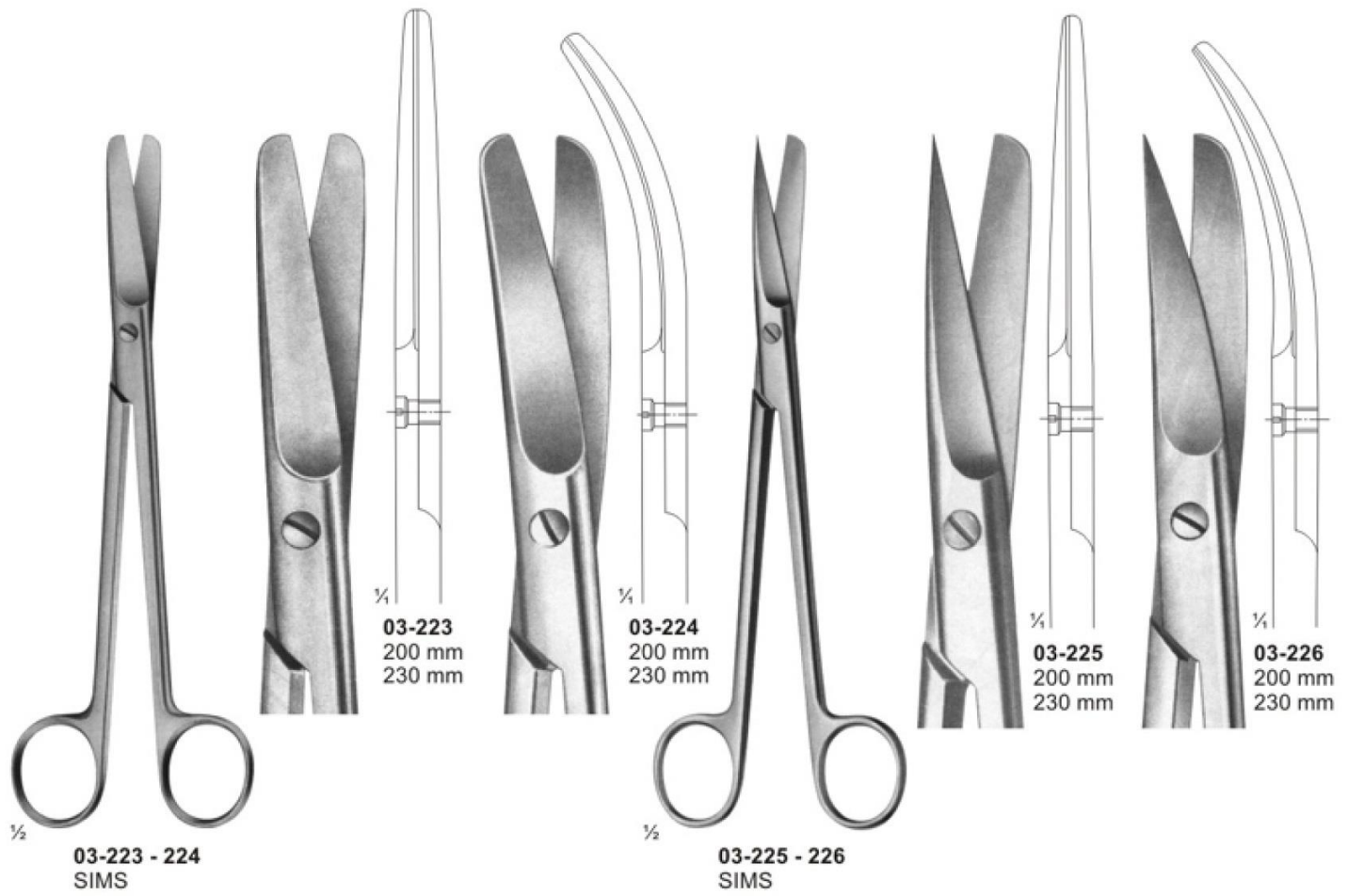



03-232
SCHUMACHER
 Umbilical cord scissors
 Size: 155 mm



03-233
 Umbilical cord scissors
 Size: 105 mm

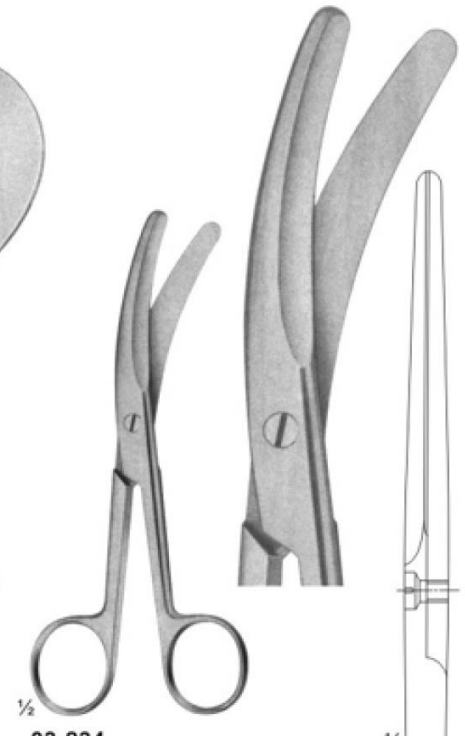

03-234
 Umbilical cord scissors

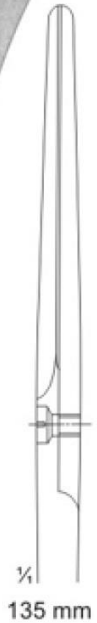

135 mm

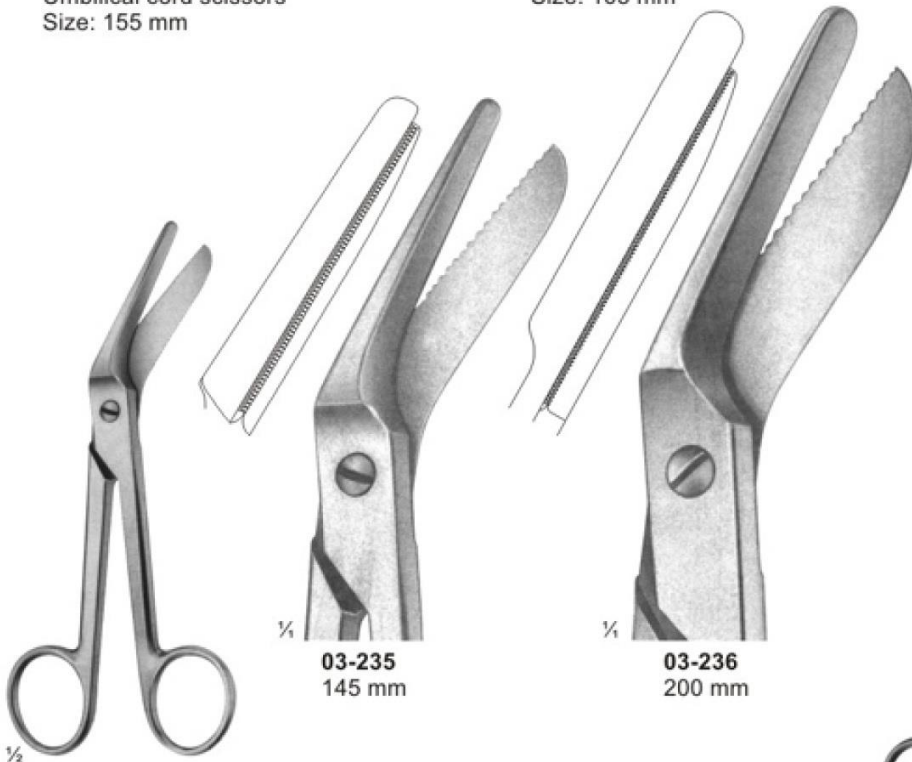

03-235
 145 mm

03-236
 200 mm

03-235 - 236
BRAUN-STADLER
 Episiotomy scissors



03-237
 Episiotomy scissors
 240 mm

Wire and Plate Scissors

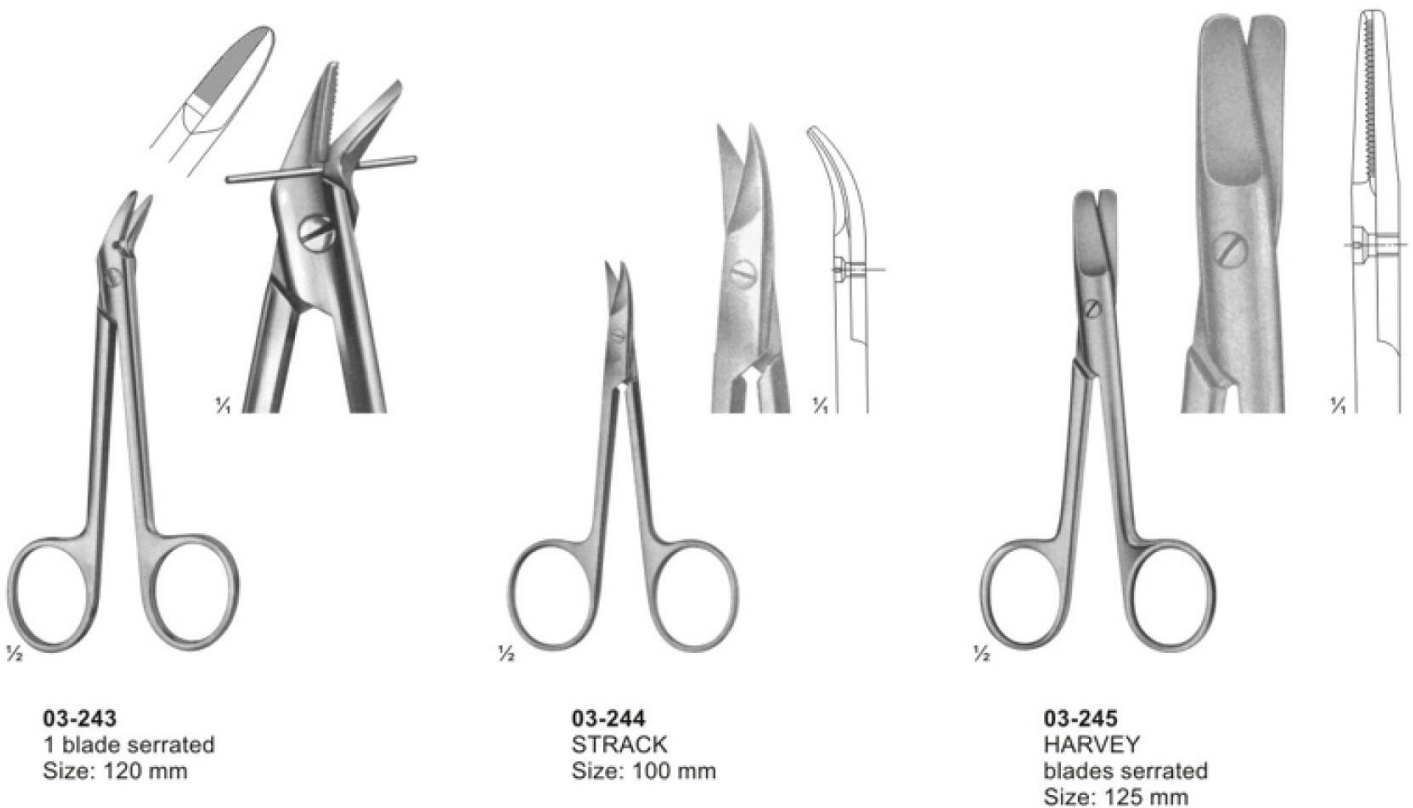
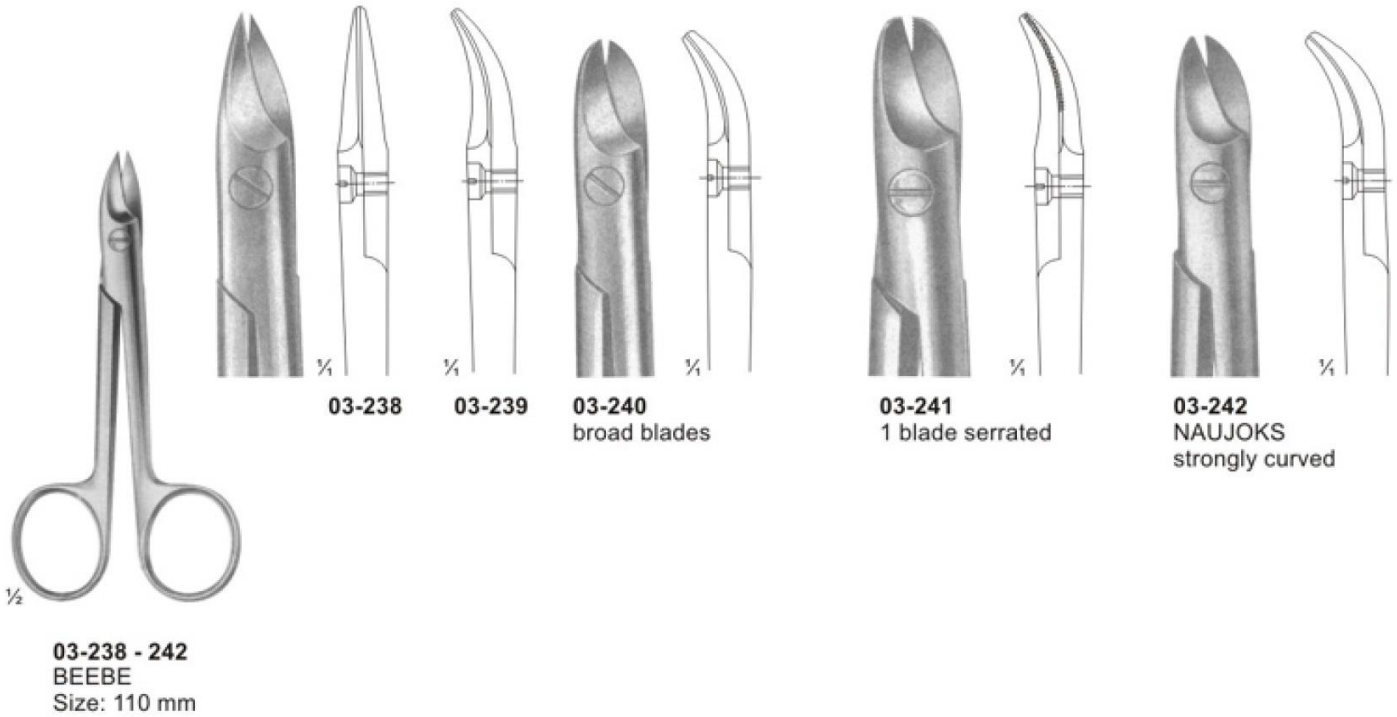

Bandage and Cloth Scissors



03-246
 Universal bandage and cloth scissors,
 with toothed edges
 180 mm



03-247
 LISTER
 Universal bandage and cloth scissors,
 with toothed edges
 Size: 145 mm

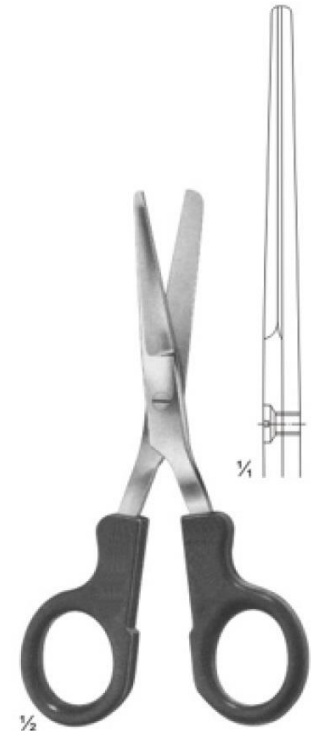

03-248
 LISTER
 Nurse's scissors
 Size: 145 mm

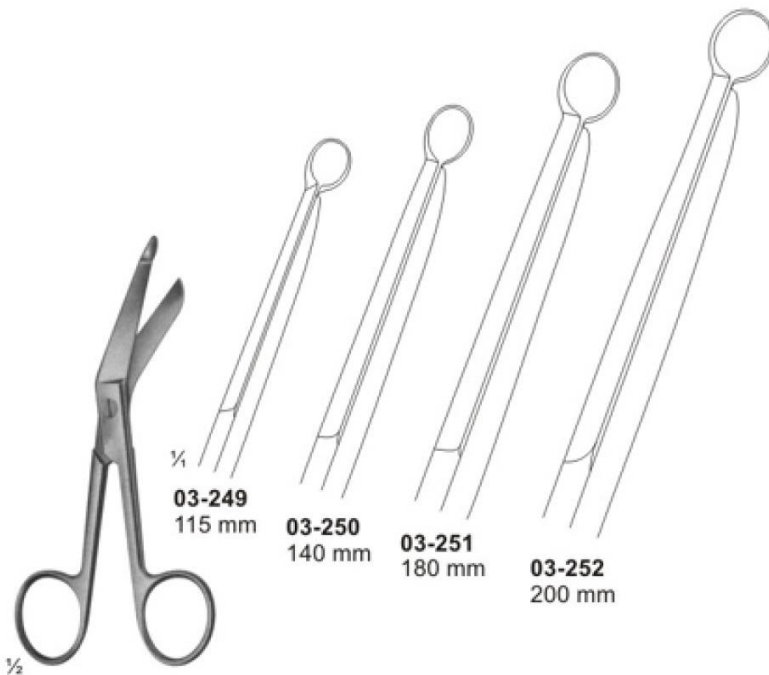

03-249 - 252
 LISTER

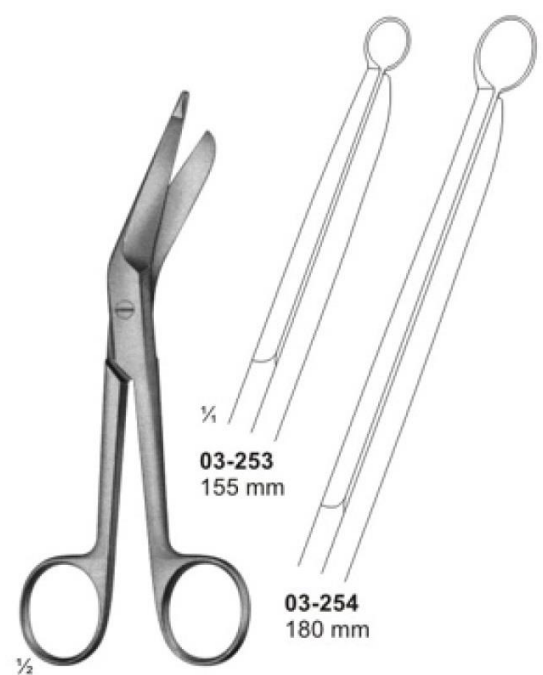

03-253 - 254
 LISTER

Bandage-, Cloth-, and Plaster Scissors



03-255
CLOTH SCISSORS
 205 mm

03-256
BRAUN-STADLER
 225 mm

03-257
SEUTIN
 230 mm

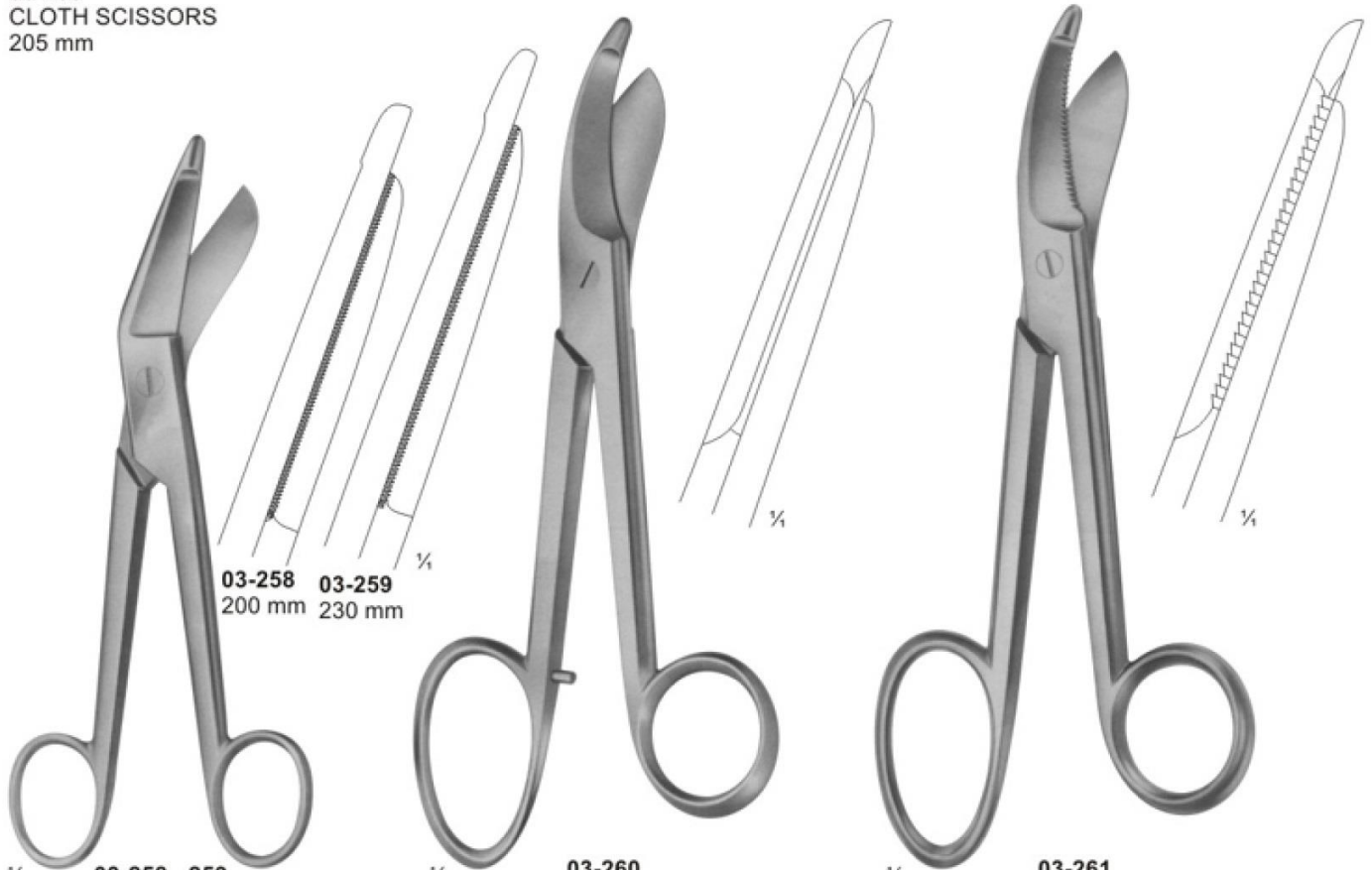

03-258 - 259
ESMARCH

03-260
BRUNS
 235 mm

03-261
Bandage Scissors
 235 mm

Forceps for grasping tissue, tumors etc.

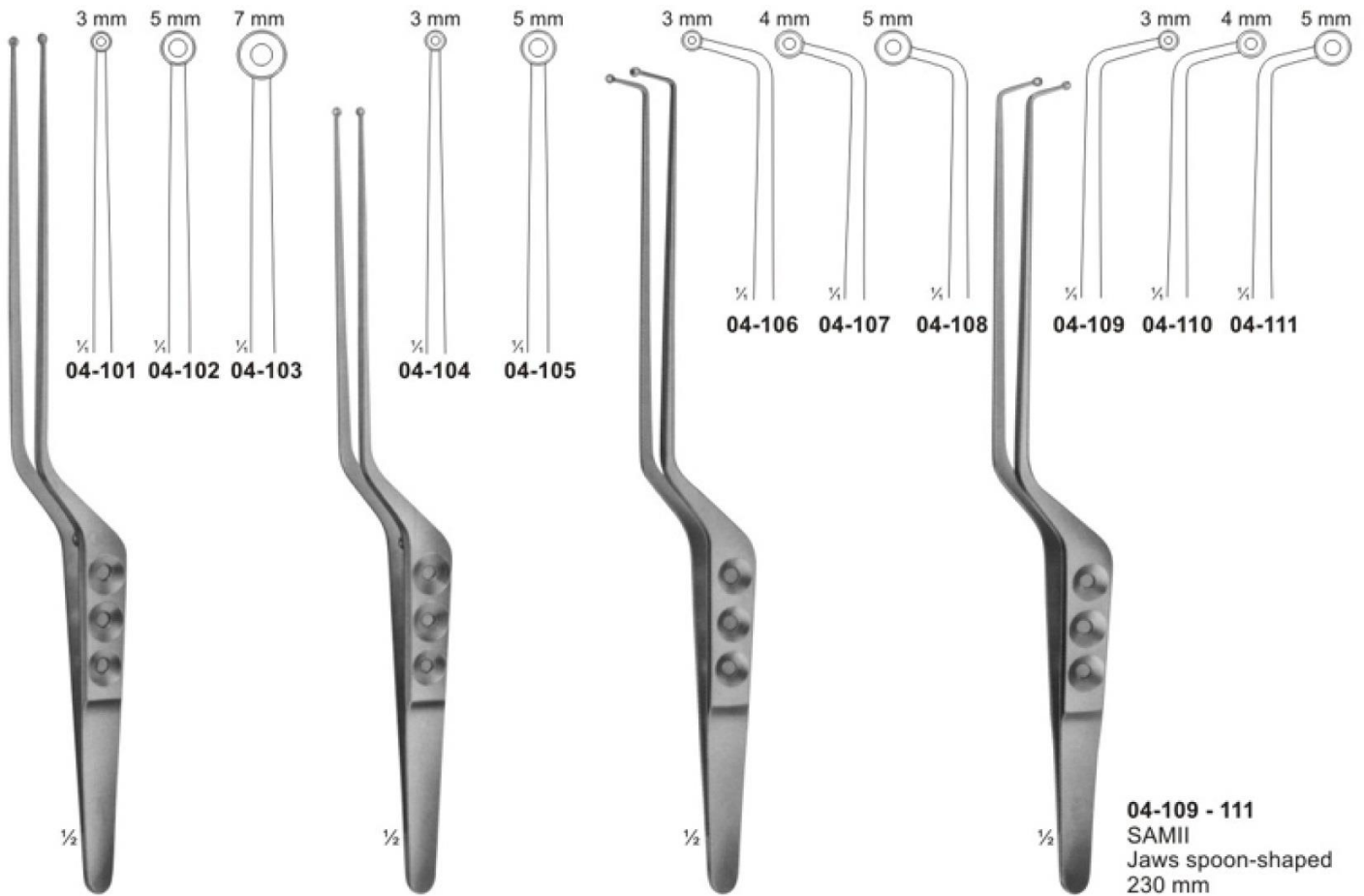

04-101 - 103
YASARGIL-SAMII
 Jaws spoon-shaped
 240 mm

04-104 - 105
YASARGIL
 Jaws spoon-shaped
 220 mm

04-106 - 108
SAMII
 Jaws spoon-shaped
 230 mm

04-109 - 111
SAMII
 Jaws spoon-shaped
 230 mm

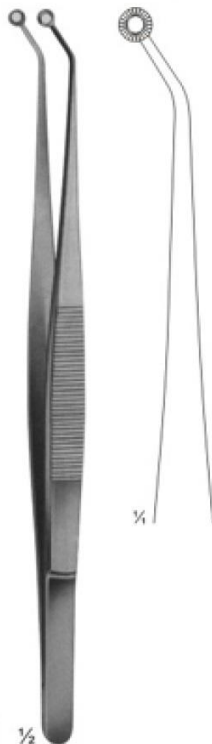

04-112
HUNT
 Tumor-and vessel forceps
 200 mm



04-113
HUNT
 Tumor-and vessel forceps
 200 mm



04-114
YASARGIL
 Tumor-and vessel forceps
 200 mm

Delicate Dissecting, Microscopic, Sterilizing Forceps

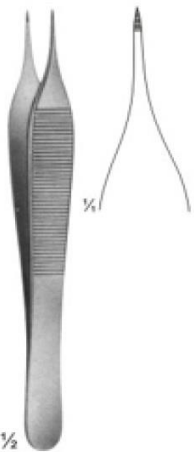

04-115
THORPE
 Corneal forceps
 120 mm

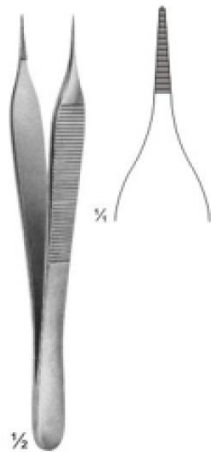

04-116
MICRO-ADSON
 120 mm

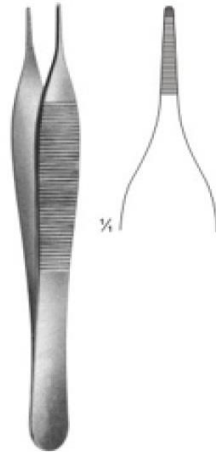

04-117
ADSON
 120 mm



04-118
MICRO-ADSON
 150 mm

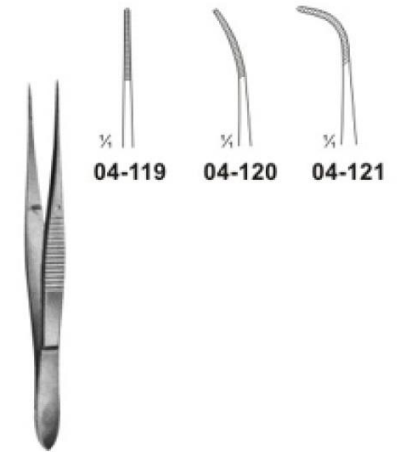

04-119 - 121
 100 mm

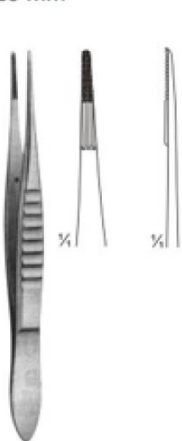

04-122
BONACCOLTO
 110 mm



04-123
 115 mm

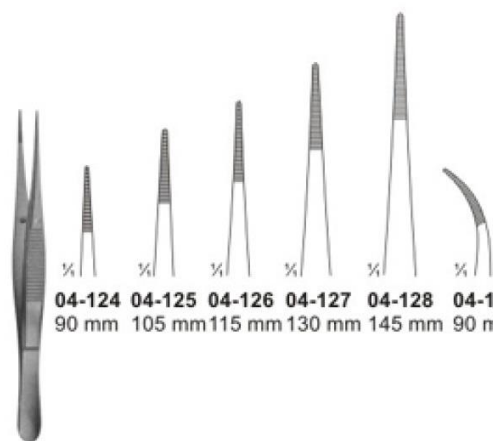

04-124 - 133

04-124 90 mm **04-125** 105 mm **04-126** 115 mm **04-127** 130 mm **04-128** 145 mm **04-129** 90 mm **04-130** 105 mm **04-131** 115 mm **04-132** 130 mm **04-133** 145 mm

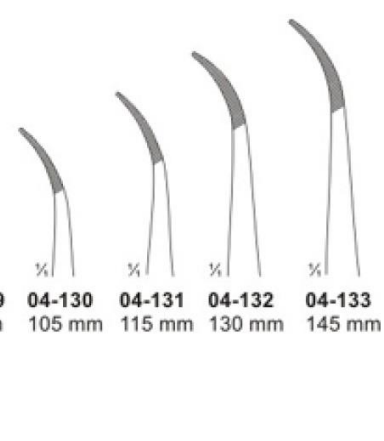

04-134
 100 mm

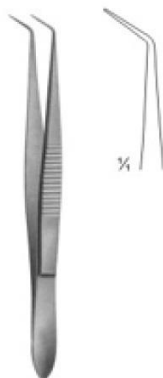

04-135
 100 mm

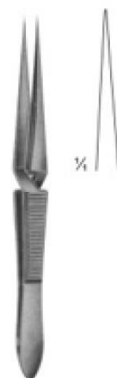

04-136
 100 mm

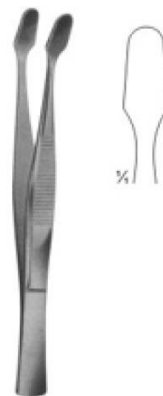

04-137
KUHNE
 Cover glass forceps, 105 mm



04-138
 160 mm

Delicate Dissecting Forceps

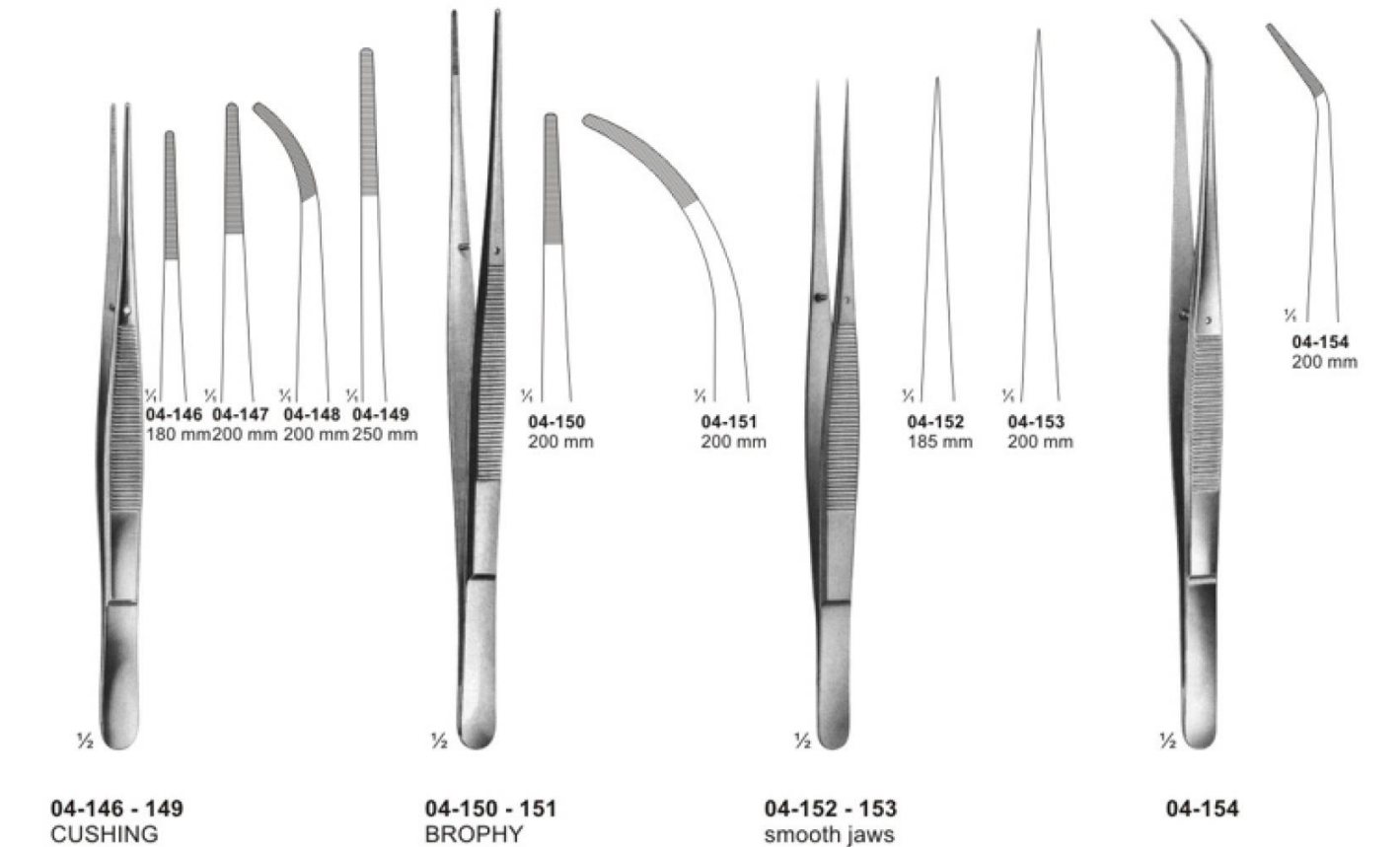
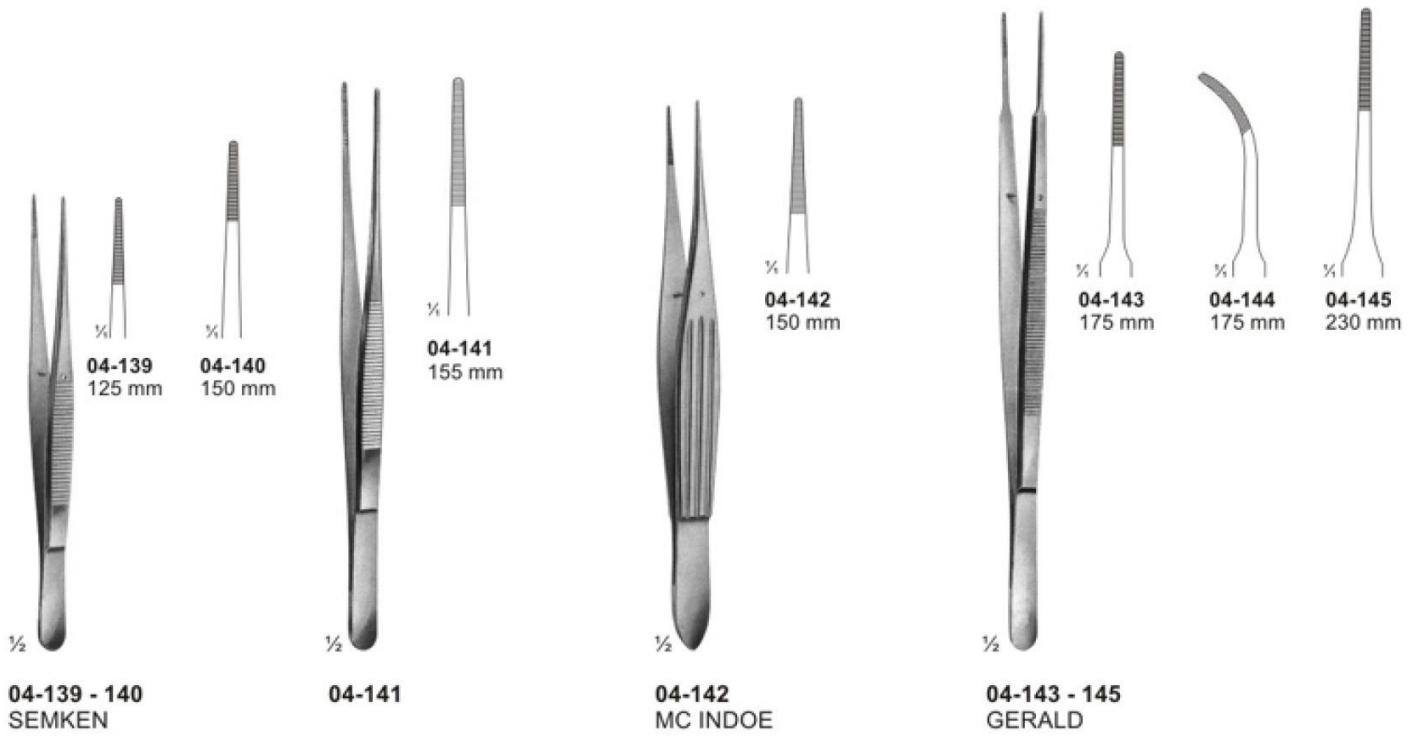

Forceps

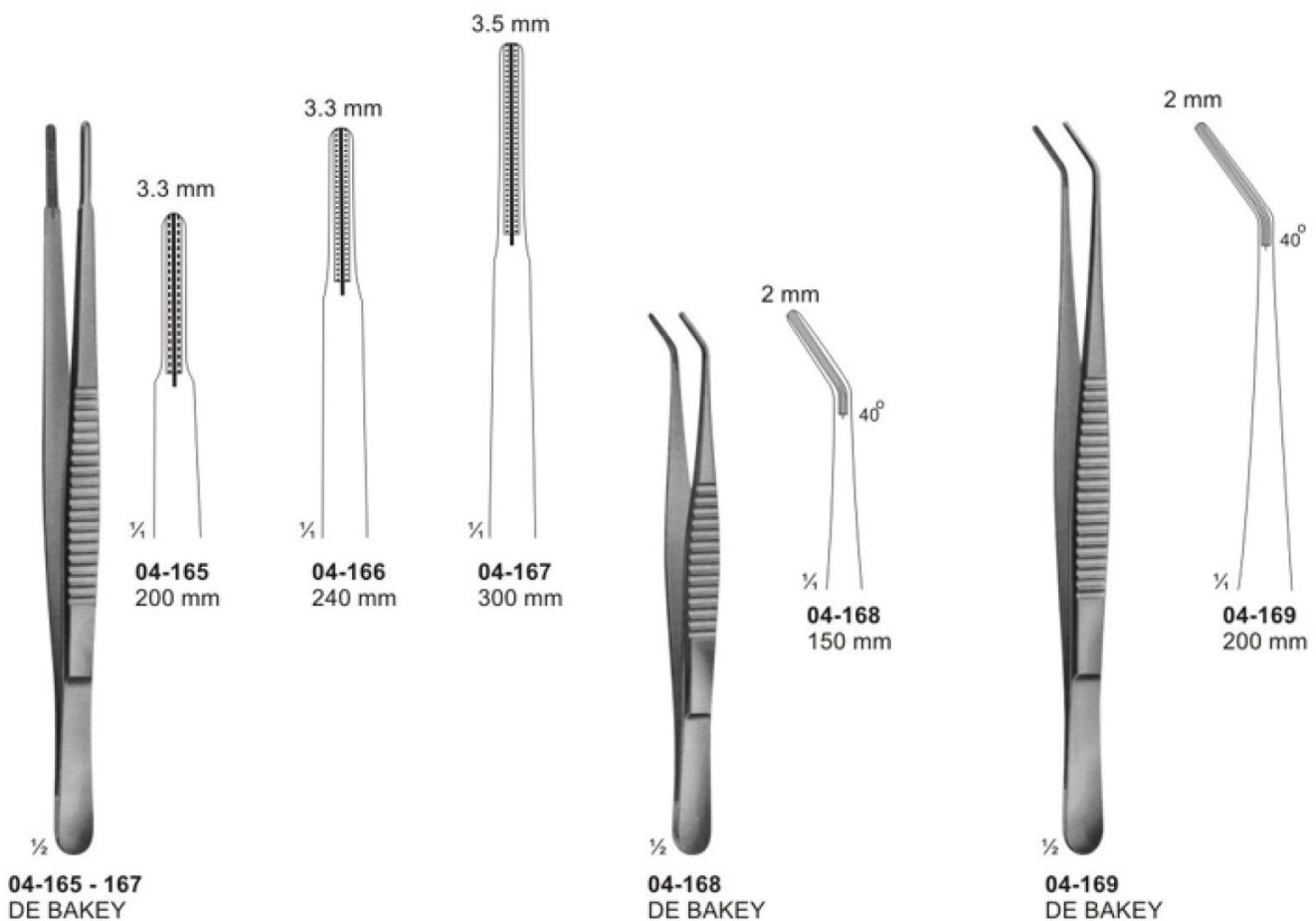
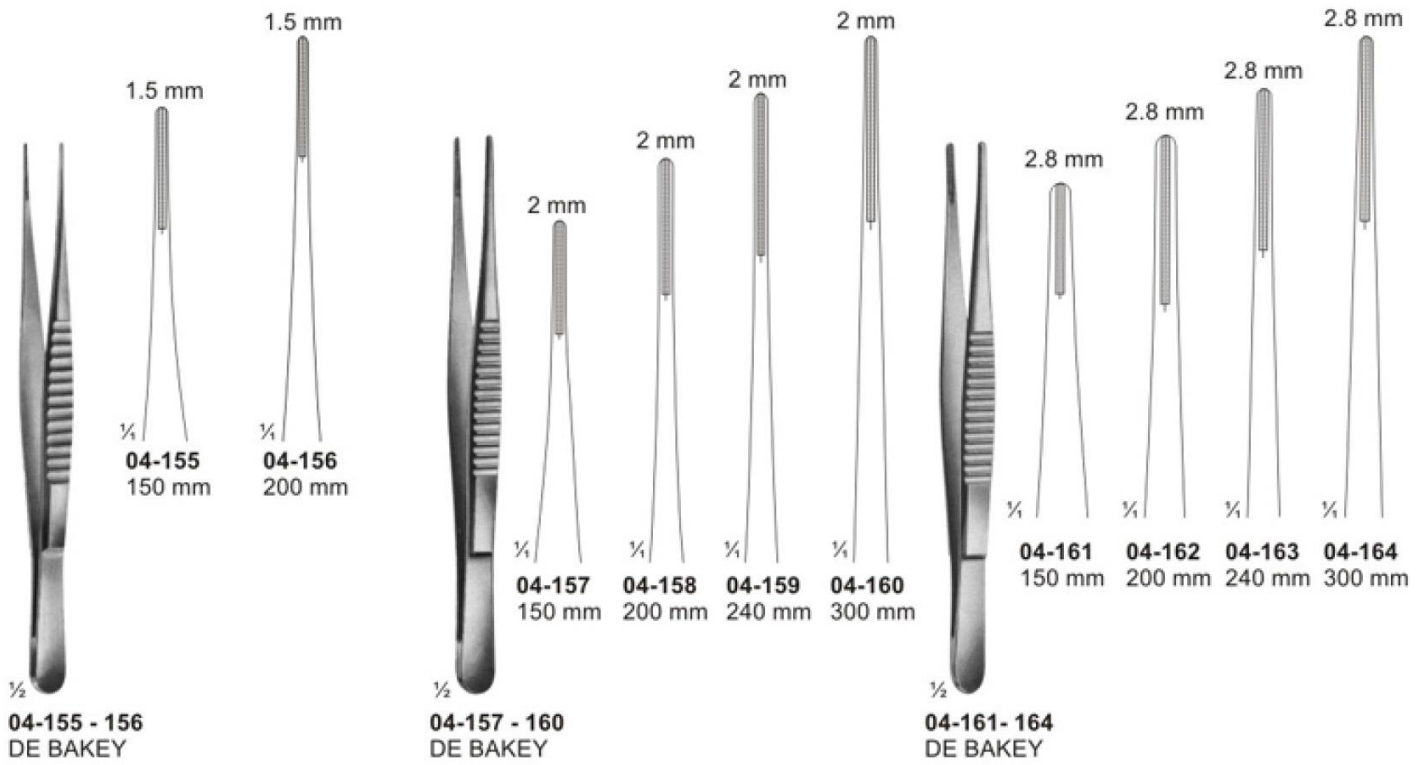

Delicate Tissue Forceps

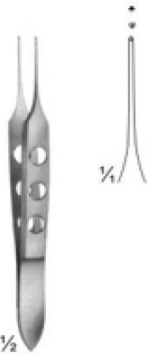

04-170
BISHOP-HARMON
 85 mm

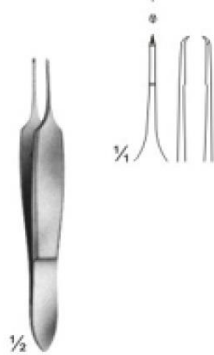

04-171
ST. MARTIN
 80 mm

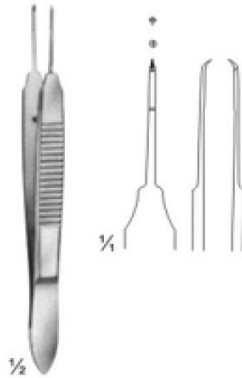

04-172
CASTROVIEJO
 teeth 0.9 mm
 100 mm

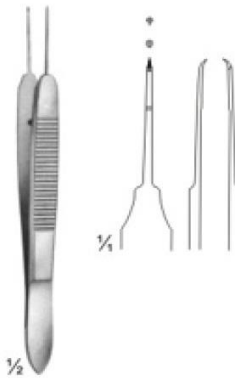

04-173
CASTROVIEJO
 teeth 0.5 mm
 100 mm

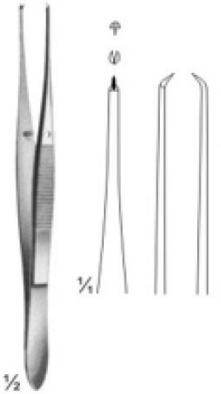

04-174
ELSCHING
 110 mm

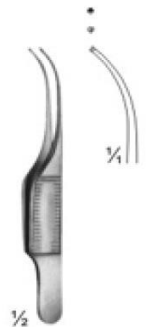

04-175
GILL
 75 mm



04-176
GILL - HESS
 75 mm

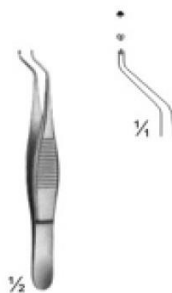

04-177
HESS
 70 mm

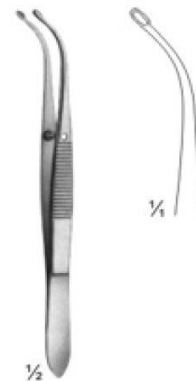

04-178
ARRUGA
 100 mm

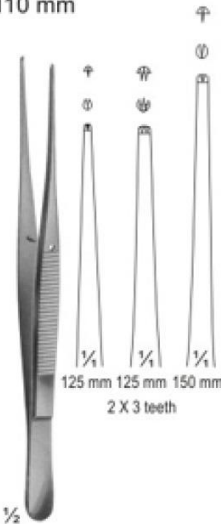

04-179
SEMKEN
 125 mm 125 mm 150 mm
 2 X 3 teeth

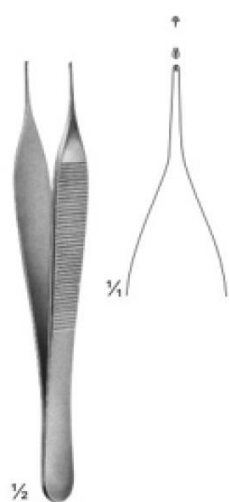

04-180
MICRO-ADSON
 120 mm

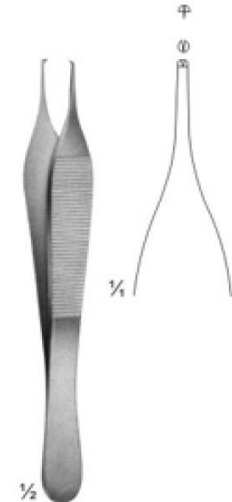

04-181
ADSON
 120 mm

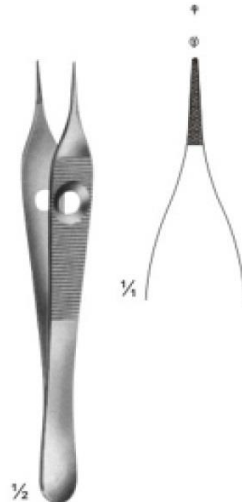

04-182
ADSON
 120 mm

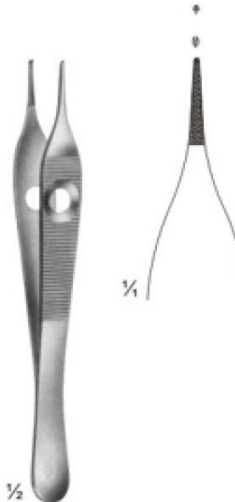

04-183
ADSON
 120 mm



04-184
ADSON
 150 mm

Tissue Forceps, Lung Dissecting Forceps



Splinter and Cilia Forceps

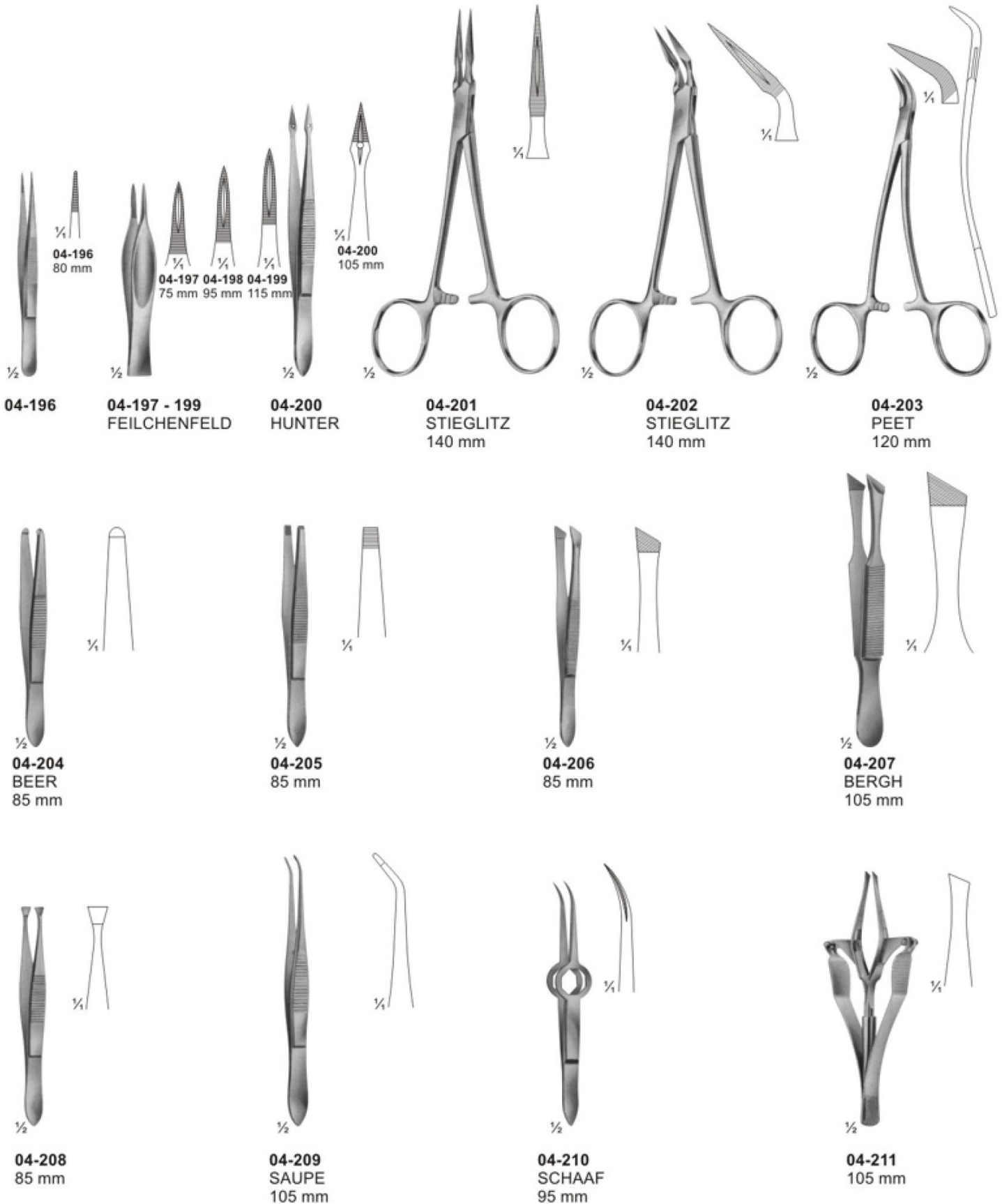

Sponge and Dressing Forceps

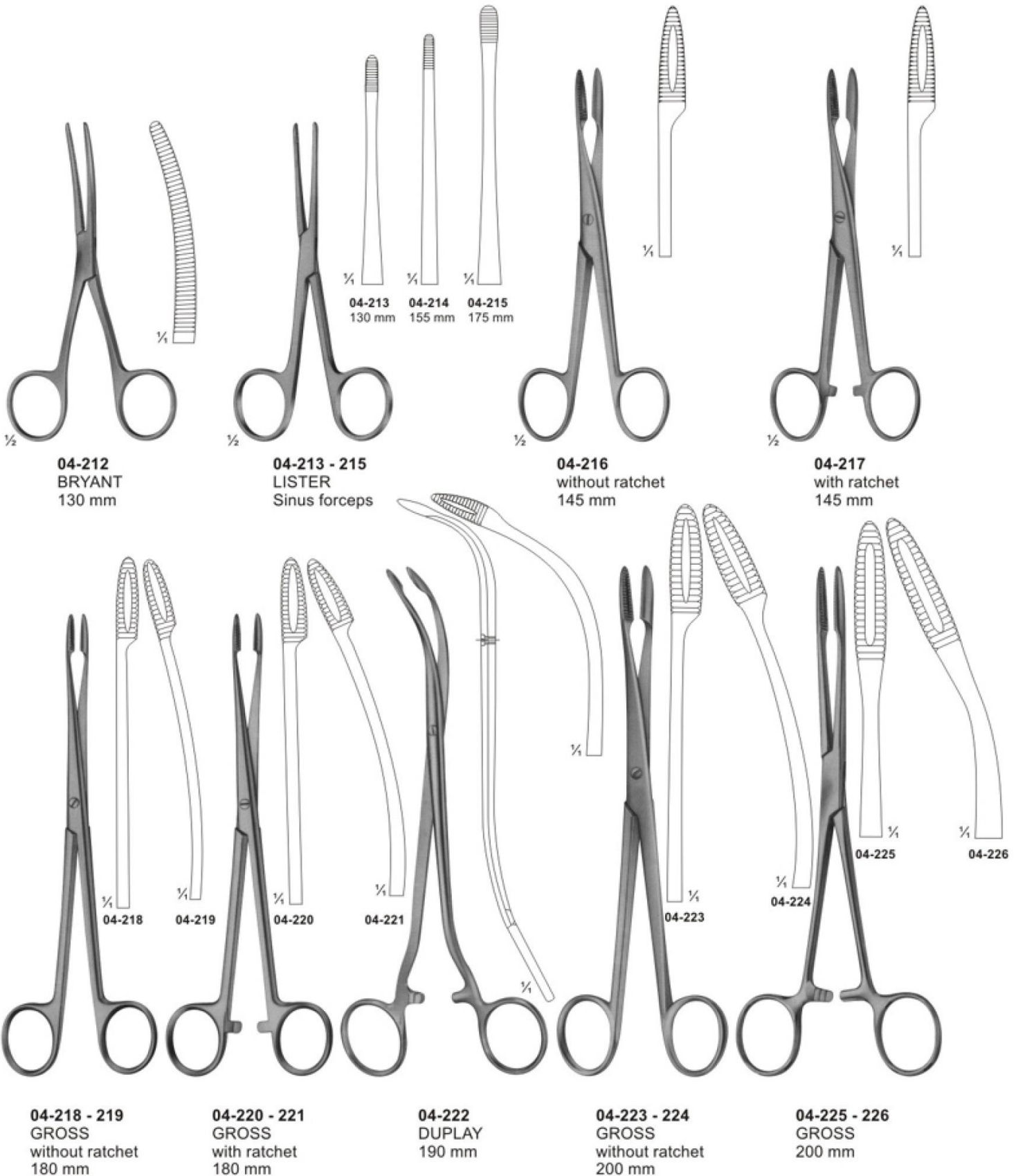

Dressing-, Sponge holding-, Organ- and Tissue Grasping Forceps

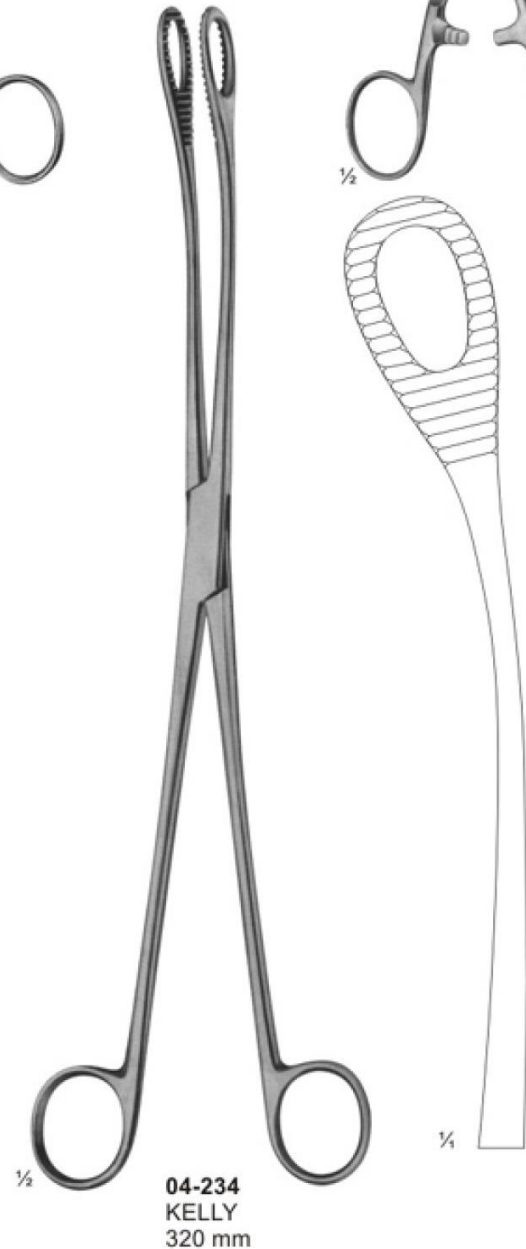
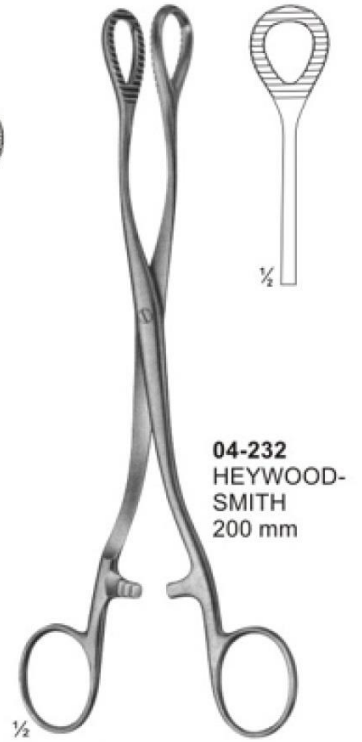
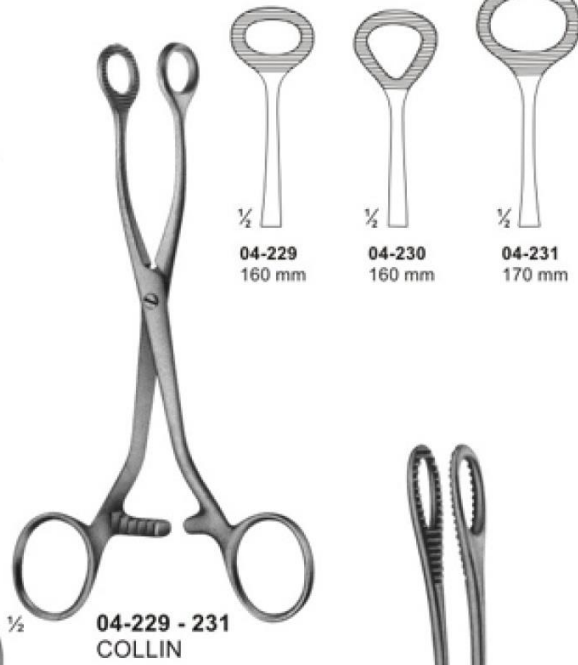

Artery Traction - and Tissue Grasping Forceps

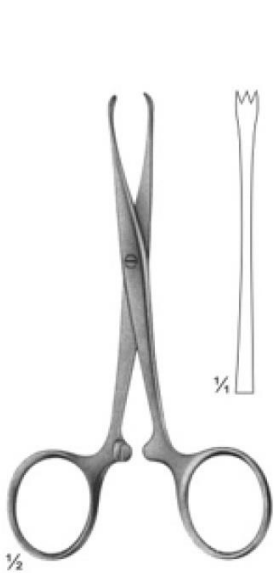

04-235
CHAPUT
 2 x 3 teeth
 125 mm

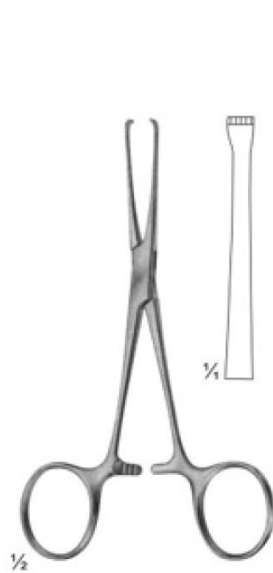

04-236
BABY-ALLIS
 4 x 5 teeth
 130 mm

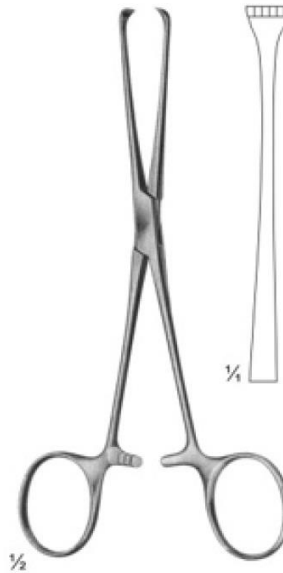

04-237
BOYS-ALLIS
 5 x 6 teeth sharp
 155 mm

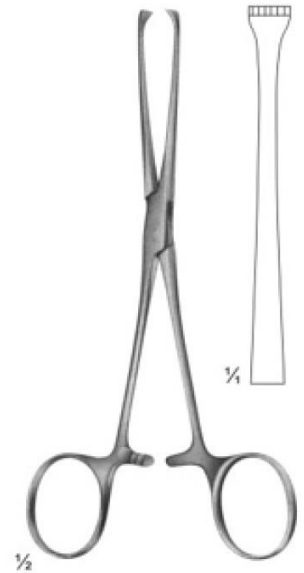

04-238
ALLIS
 5 x 6 teeth
 155 mm



04-239
LAHEY
 155 mm

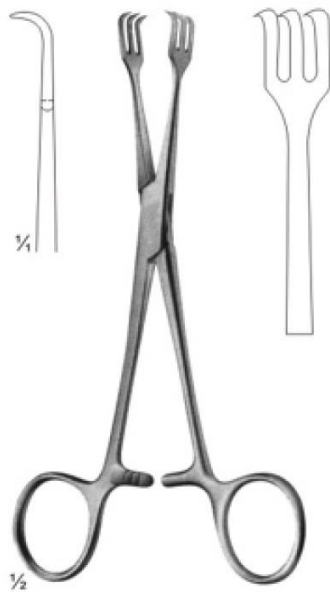

04-240
LAHEY
 155 mm

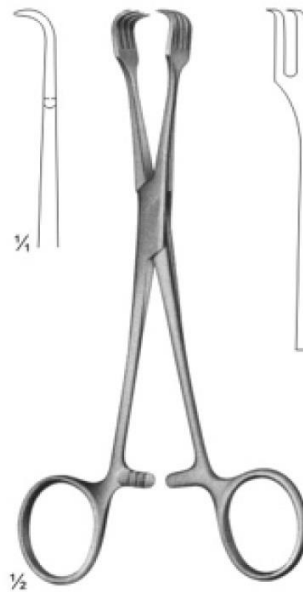

04-241
BRAUN
 155 mm

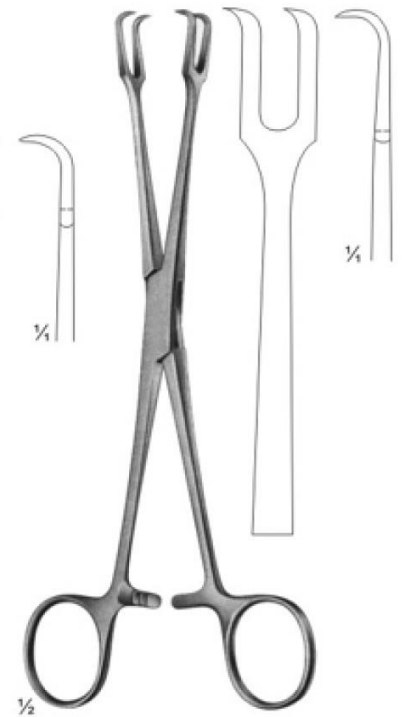

04-242
MUSEUX
 200 mm

Towel Clamps

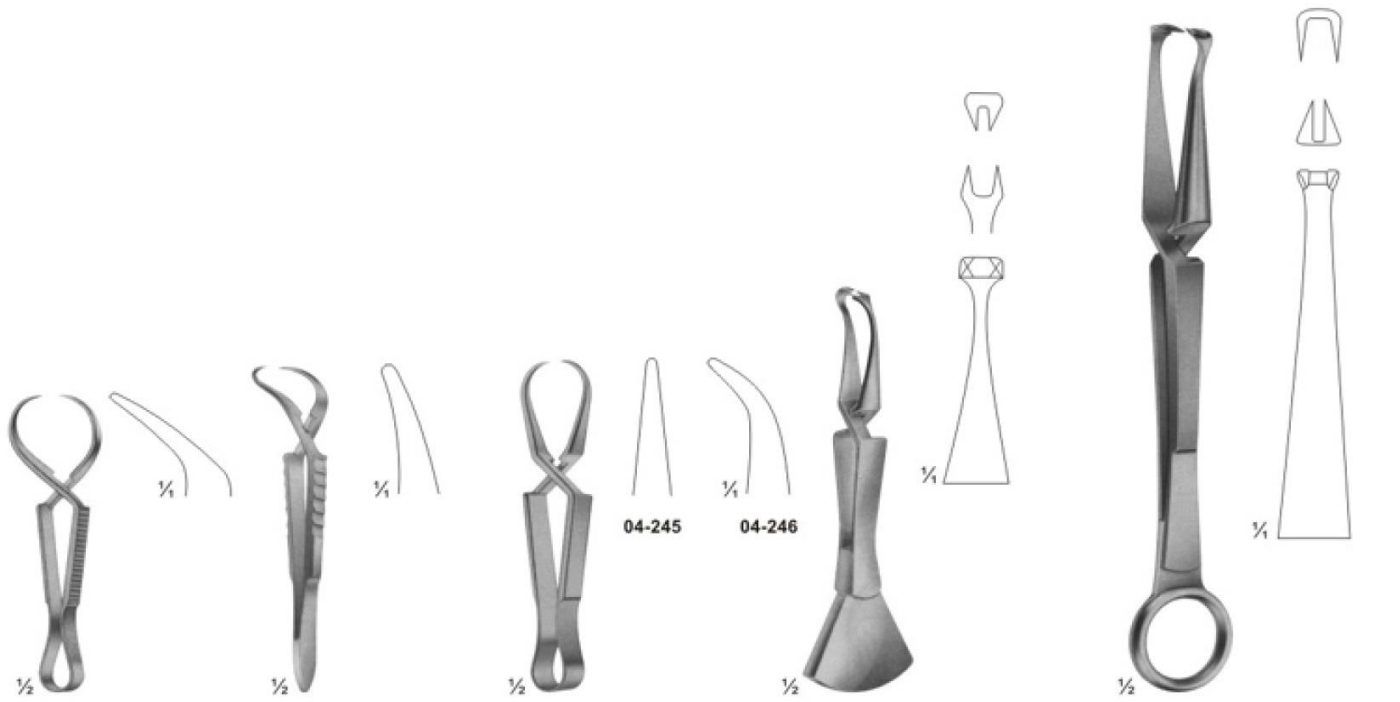

04-243
JONES
 85 mm

04 - 244
ENGL. MOD.
 85 mm

04 245 - 246
SCHAEDEL
 85 mm

04-247
DOYEN
 110 mm

04-248
DOYEN
 180 mm

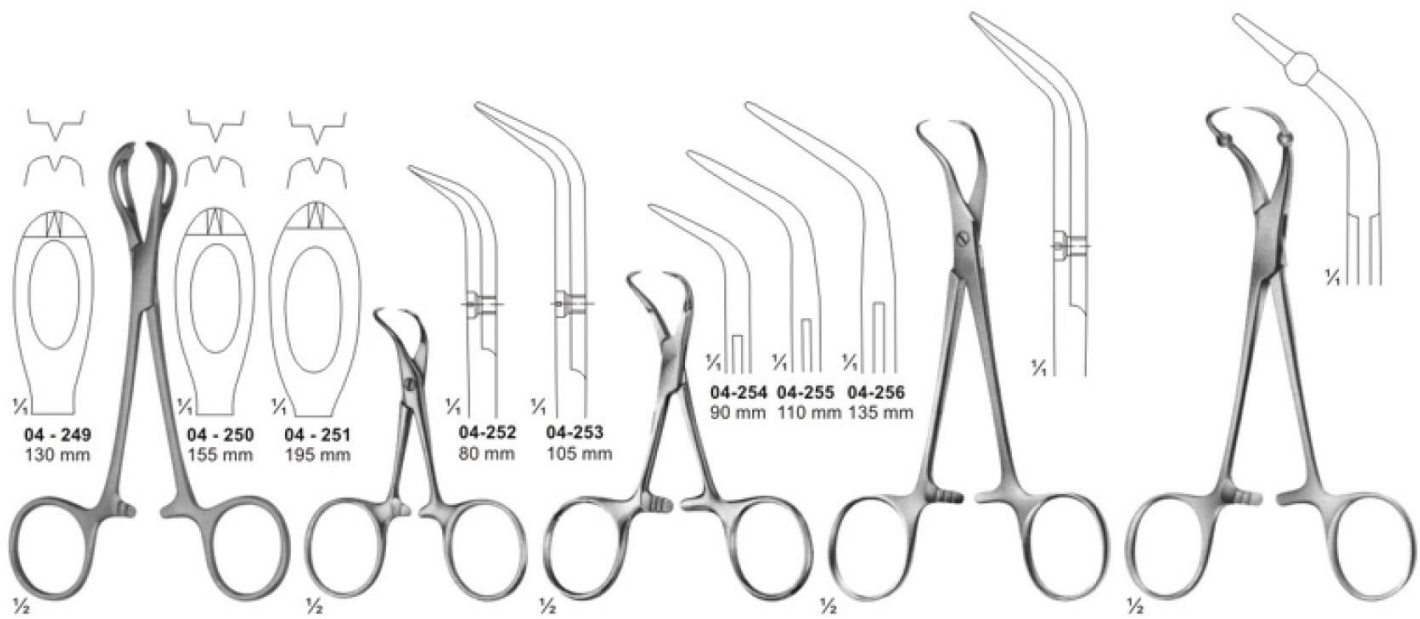

04 - 249
 130 mm

04 - 250
 155 mm

04 - 251
 195 mm

04-252
 80 mm

04-253
 105 mm

04-254 04-255 04-256
 90 mm 110 mm 135 mm

04-249 - 251
LANE

04-252 - 253
BACKHAUS

04-254 - 256
BACKHAUS

04-257
BACKHAUS-KOCHER
 135 mm

04-258
ROEDER
 135 mm

Muller Vessel Clips and Bulldog Clamps

Closing force

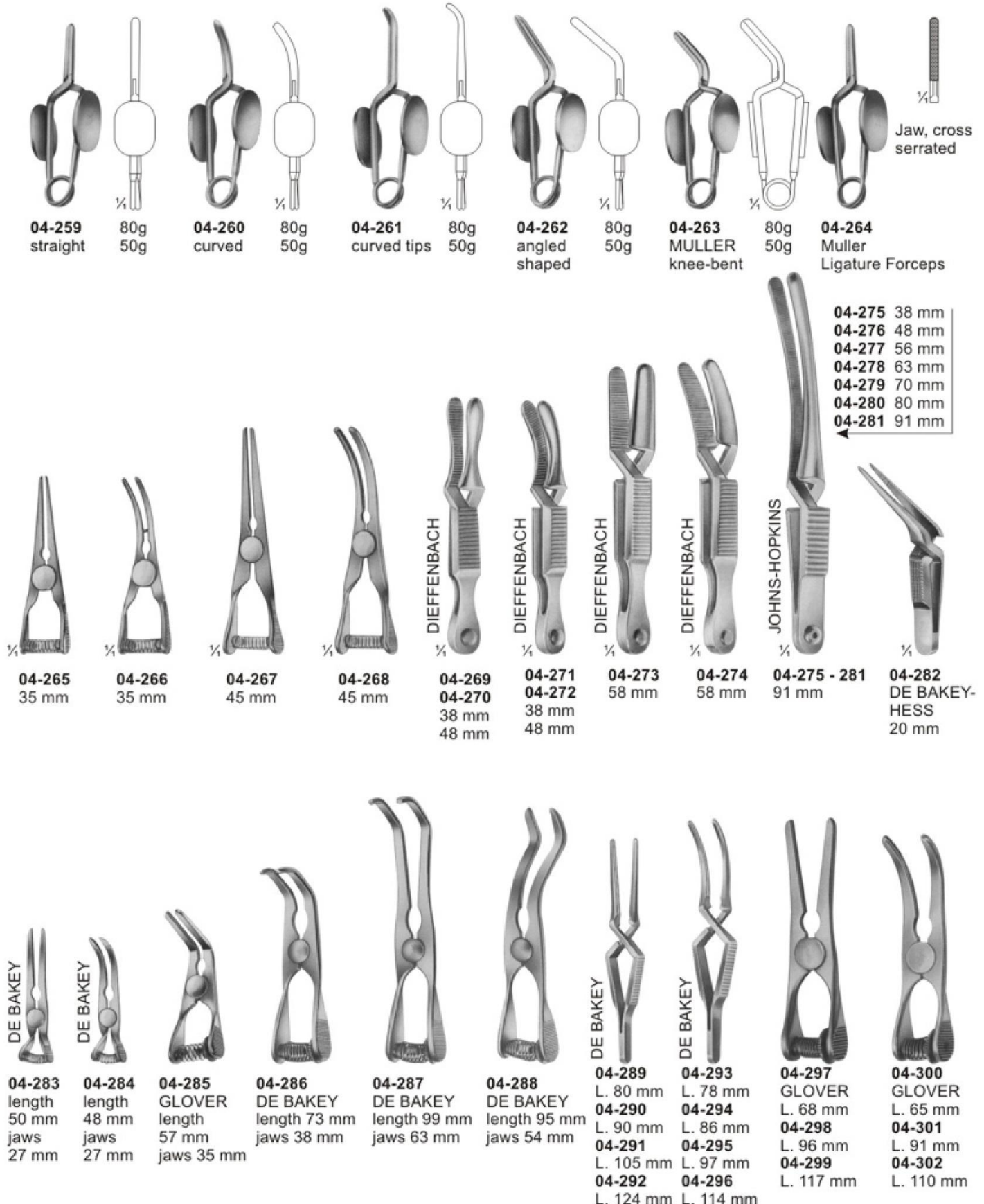

04-259 straight 80g 50g
04-260 curved 80g 50g
04-261 curved tips 80g 50g
04-262 angled shaped 80g 50g
04-263 MULLER knee-bent 80g 50g
04-264 Muller Ligature Forceps

Jaw, cross serrated

04-265 35 mm
04-266 35 mm
04-267 45 mm
04-268 45 mm
04-269 DIEFFENBACH 38 mm
04-270 DIEFFENBACH 48 mm
04-271 DIEFFENBACH 38 mm
04-272 DIEFFENBACH 48 mm
04-273 DIEFFENBACH 58 mm
04-274 DIEFFENBACH 58 mm
04-275 - 281 JOHNS-HOPKINS 91 mm
04-282 DE BAKEY-HESS 20 mm

04-275 38 mm
04-276 48 mm
04-277 56 mm
04-278 63 mm
04-279 70 mm
04-280 80 mm
04-281 91 mm

04-283 DE BAKEY length 50 mm jaws 27 mm
04-284 DE BAKEY length 48 mm jaws 27 mm
04-285 GLOVER length 57 mm jaws 35 mm
04-286 DE BAKEY length 73 mm jaws 38 mm
04-287 DE BAKEY length 99 mm jaws 63 mm
04-288 DE BAKEY length 95 mm jaws 54 mm
04-289 DE BAKEY L. 80 mm
04-290 DE BAKEY L. 90 mm
04-291 DE BAKEY L. 105 mm
04-292 DE BAKEY L. 124 mm
04-293 DE BAKEY L. 78 mm
04-294 DE BAKEY L. 86 mm
04-295 DE BAKEY L. 97 mm
04-296 DE BAKEY L. 114 mm
04-297 GLOVER L. 68 mm
04-298 GLOVER L. 96 mm
04-299 GLOVER L. 117 mm
04-300 GLOVER L. 65 mm
04-301 GLOVER L. 91 mm
04-302 GLOVER L. 110 mm

Delicate Haemostatic Forceps

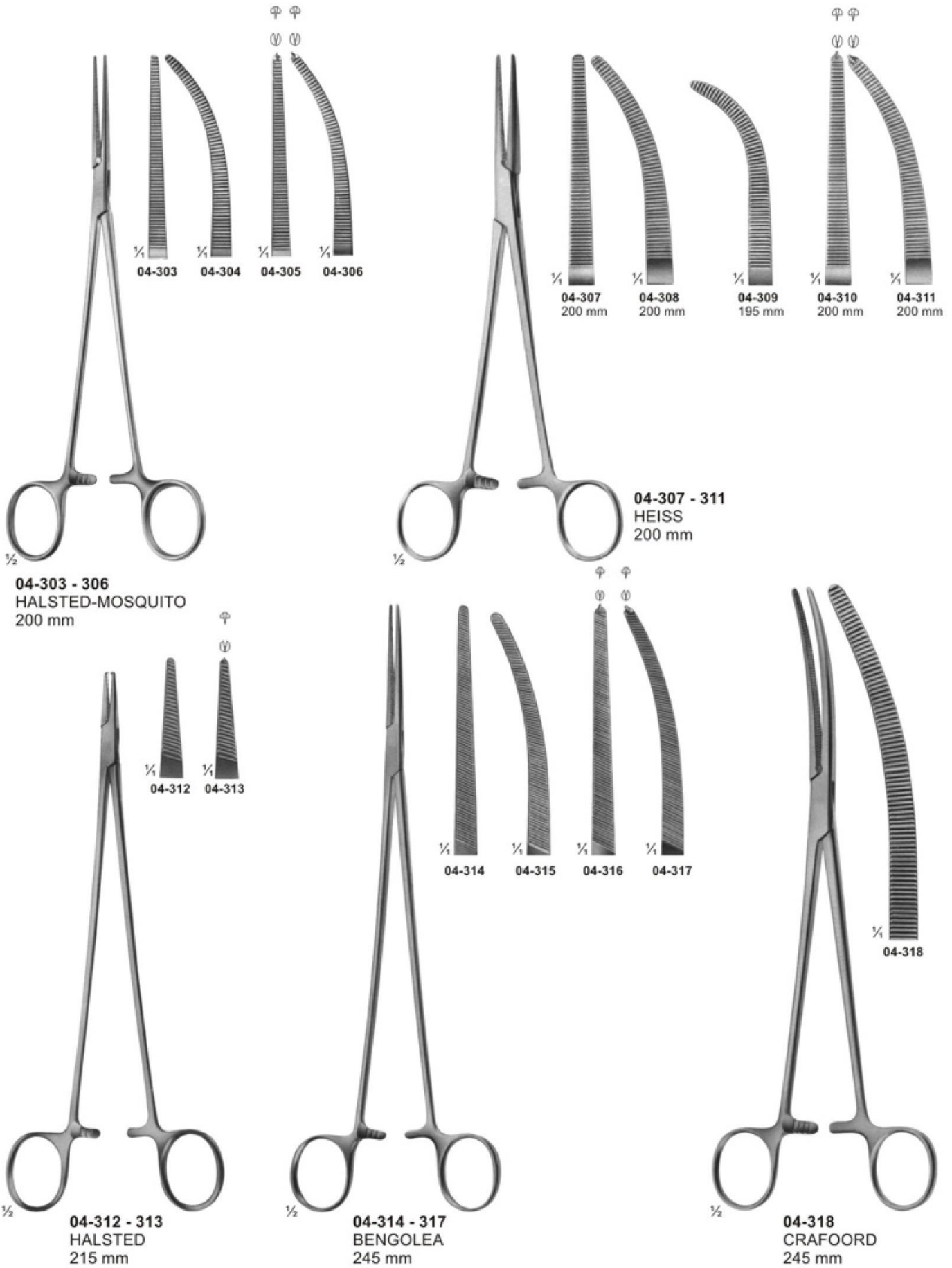

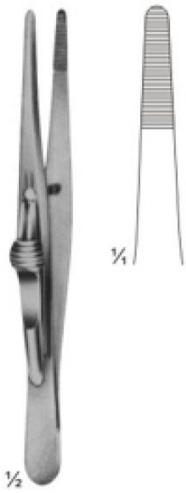

04-319
FRICKE
 Artery forceps
 130 mm

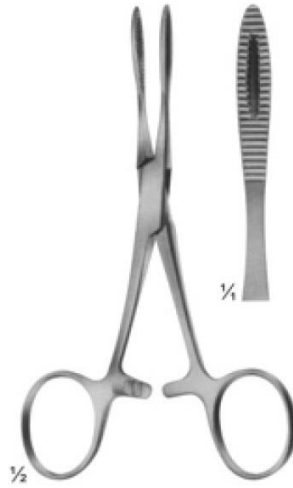

04-320
KRONLEIN
 130 mm

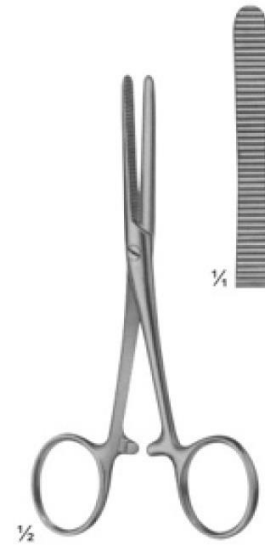

04-321
PEAN
 125 mm



04-322 - 323
PEAN

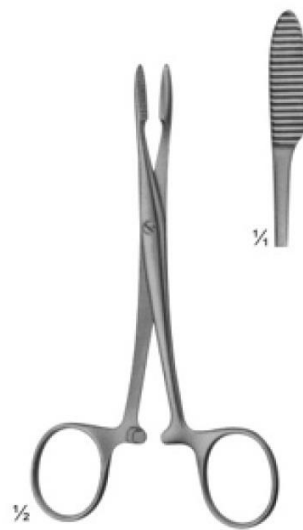

04-324
PEAN
 125 mm

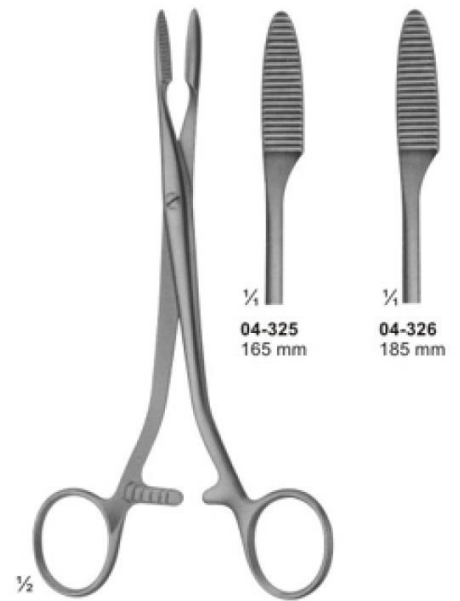

04-325 - 326
PEAN

Haemostatic Forceps, Special Pattern, Tonsil Forceps

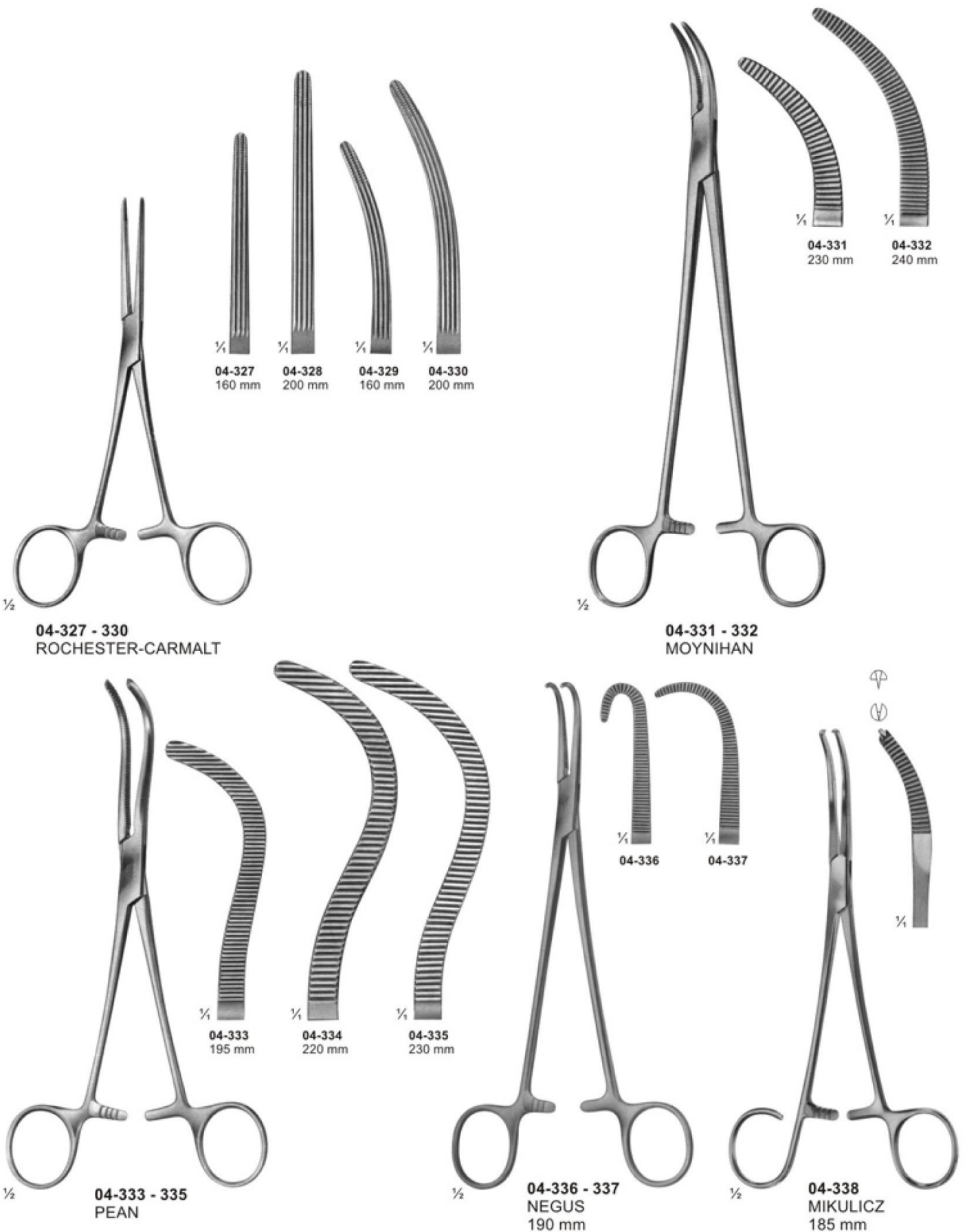

Dissecting- and Ligature Forceps



04-339
MIXTER-O'SHAUGHNESSY
 190 mm

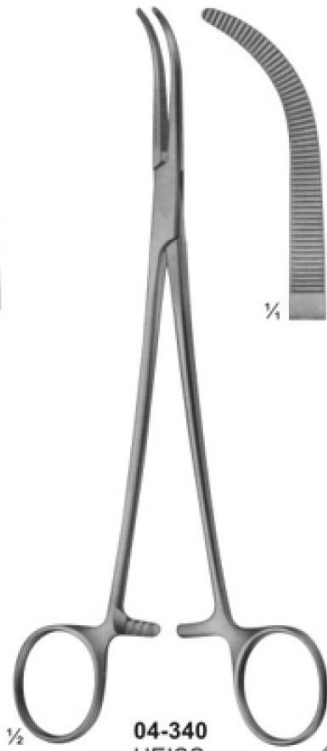

04-340
HEISS
 195 mm

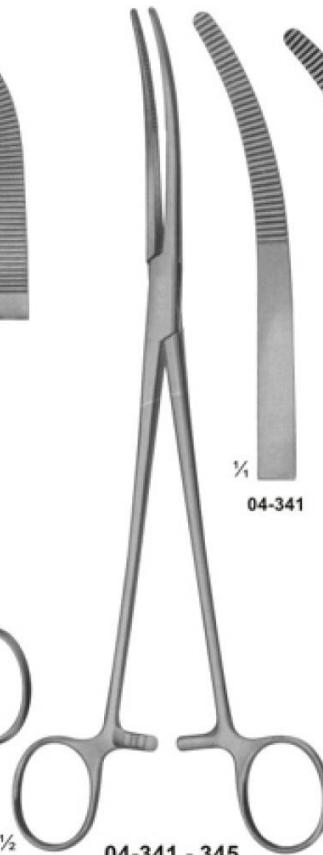

04-341 - 345
RUMEL
 240 mm

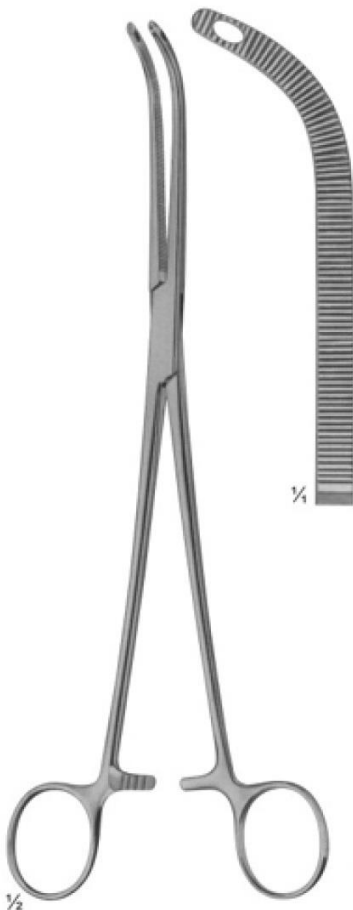
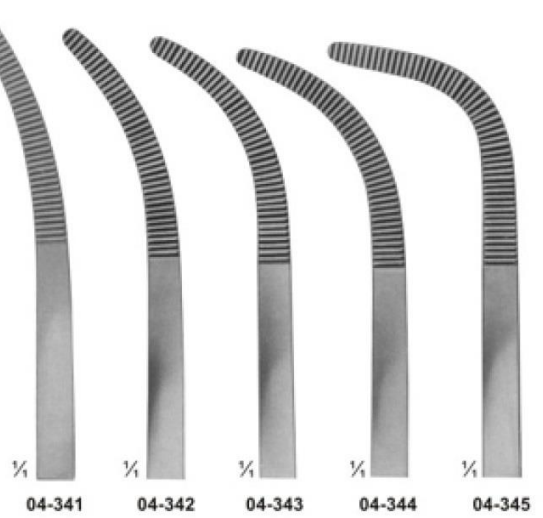

04-346
FINOCHIETTO
 245 mm

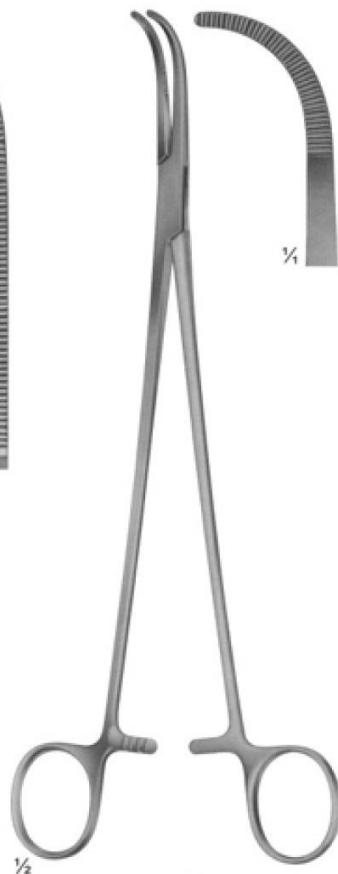

04-347
MIXTER
 230 mm



04-348
LAWRENCE
 270 mm

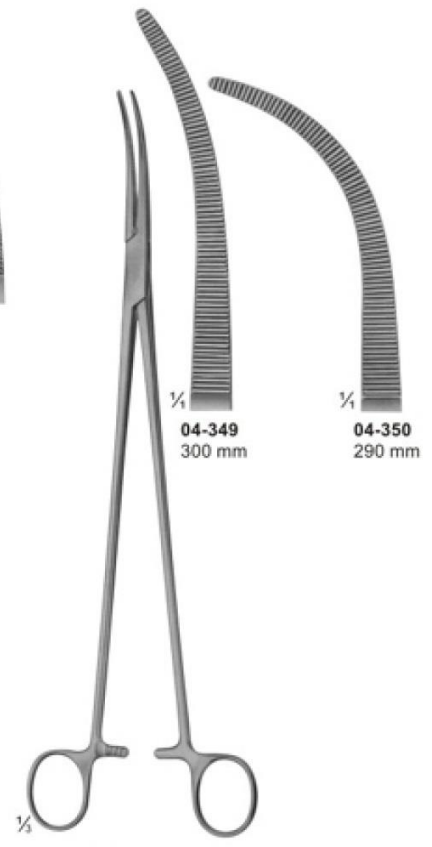

04-349 - 350
ZENKER

Hysterectomy Forceps, Vaginal Clamps
and Compression Forceps

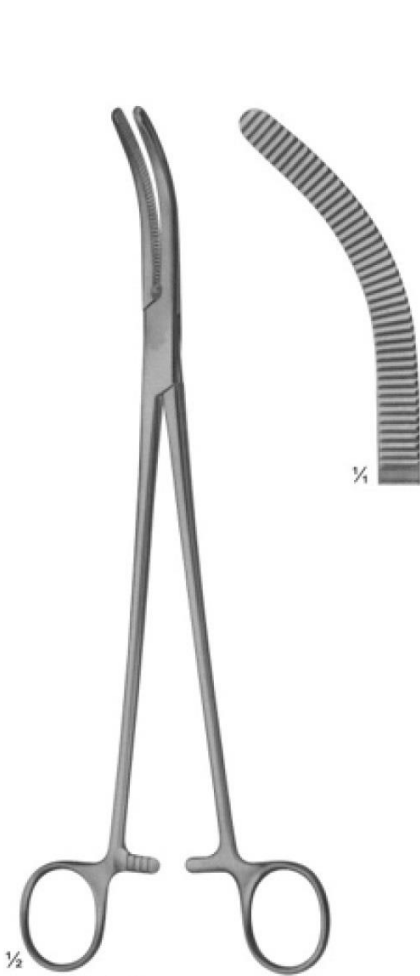

04-351
WERTHEIM
Hysterectomy forceps
255 mm

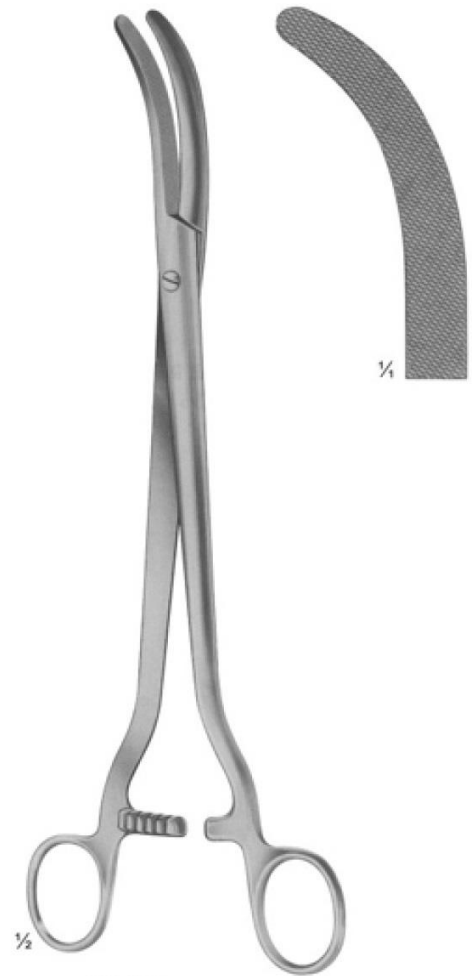

04-352
WERTHEIM
Parametrium clamp
260 mm

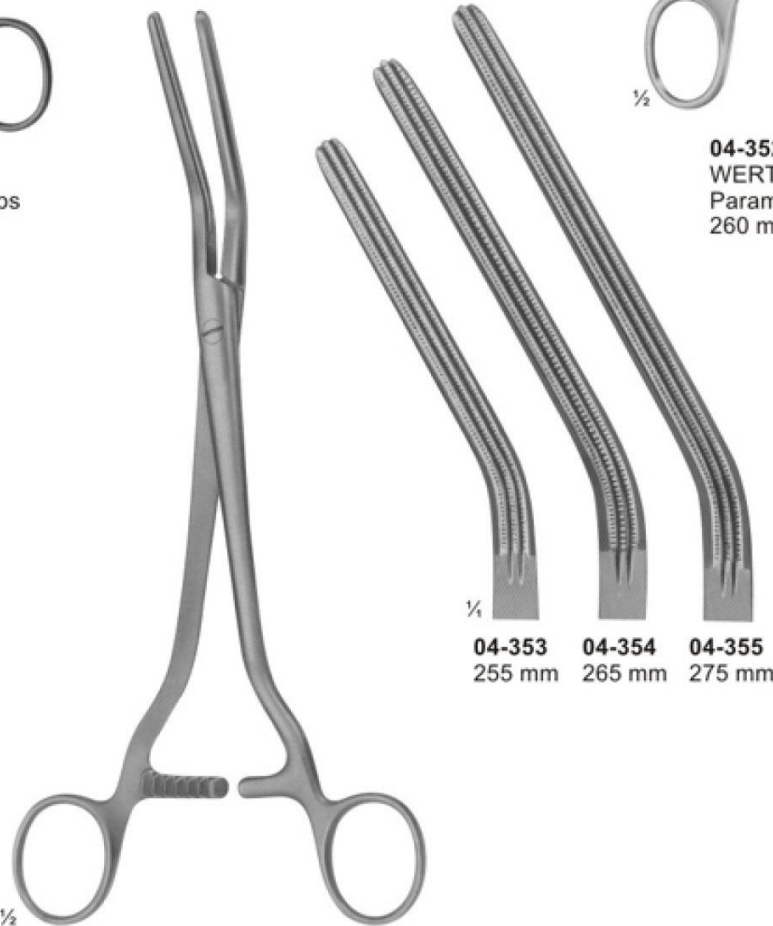

04-353 - 355
DICK

04-353 255 mm
04-354 265 mm
04-355 275 mm

Hysterectomy Forceps, Vaginal Clamps and Compression Forceps

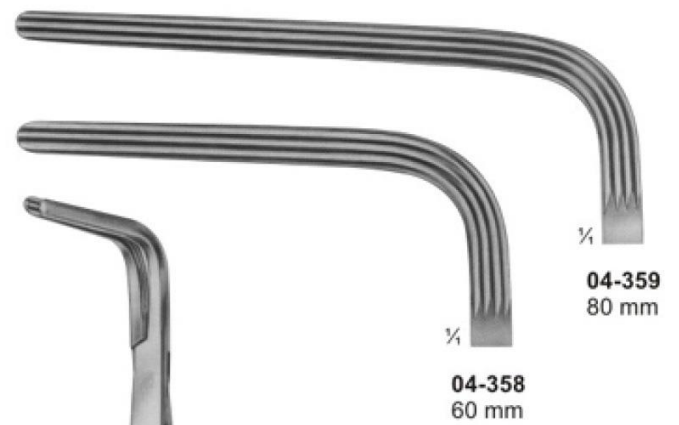

Needle Holders for micro surgery



05-101
ROHRSCHEIDER
 with copper inserts
 100 mm



05-102
KALT
 with catch
 135 mm



05-103
ARRUGA
 with catch
 135 mm



05-104 - 105
CASTROVIEJO
 with catch
 145 mm



05-106 - 107
 without Catch
 160 mm



05-108 - 109
 without catch
 185 mm



05-109



05-110 - 111
JACOBSON
 with catch
 185 mm



05-110
 without catch



05-111
 with catch



05-112
 without catch
 195 mm



05-113 - 114
YASARGIL
 with catch
 200 mm

Needle Holders

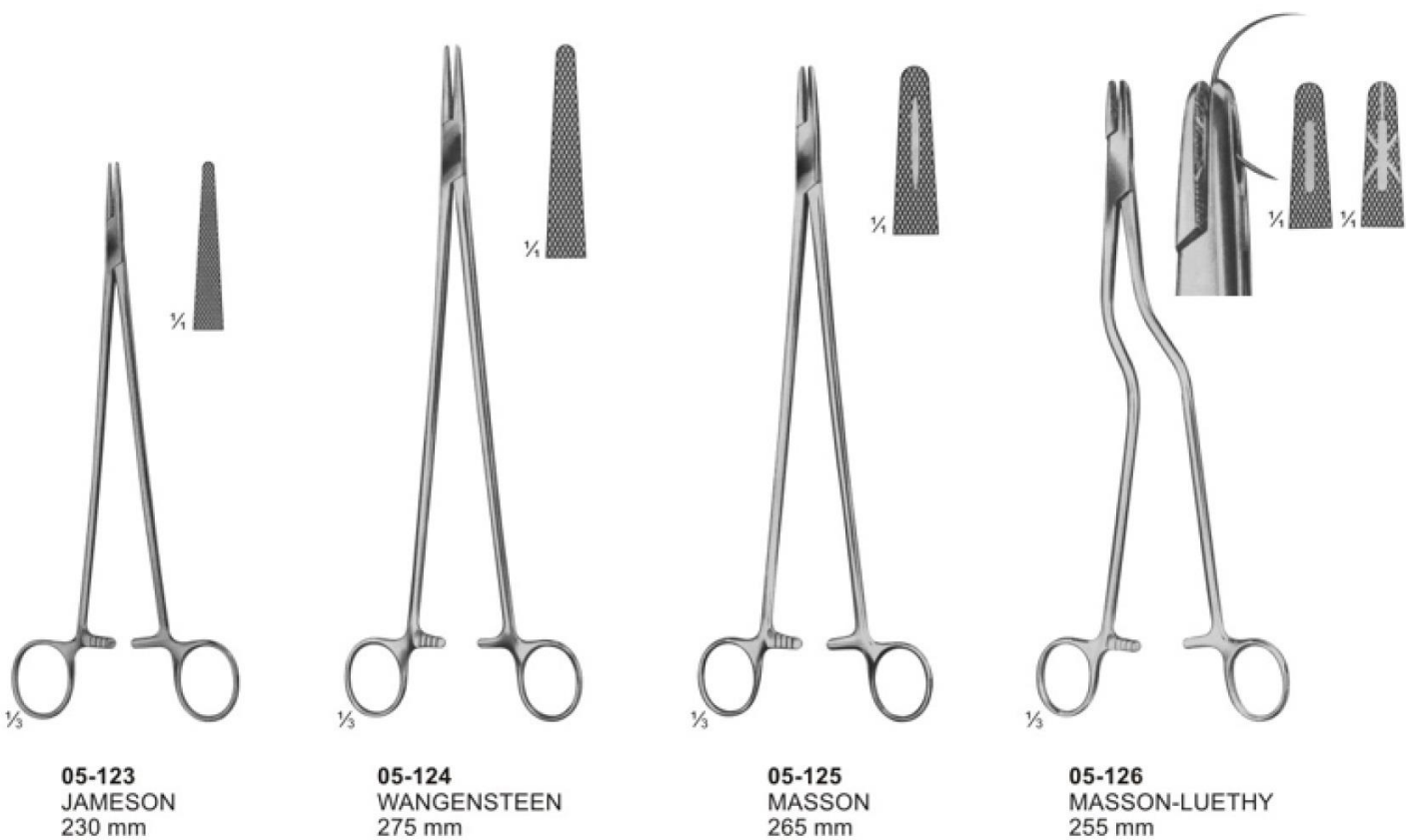
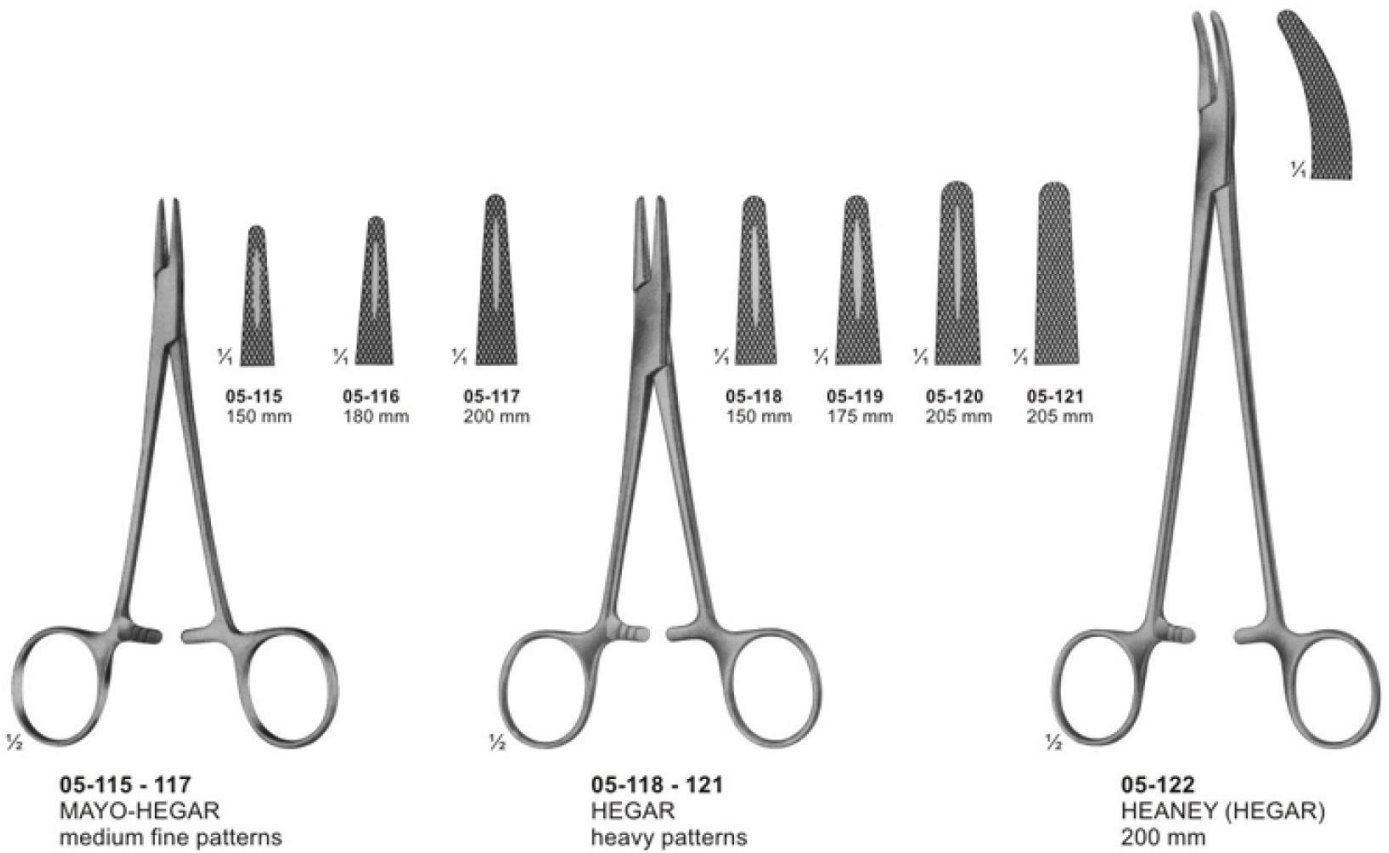

Needle Holders

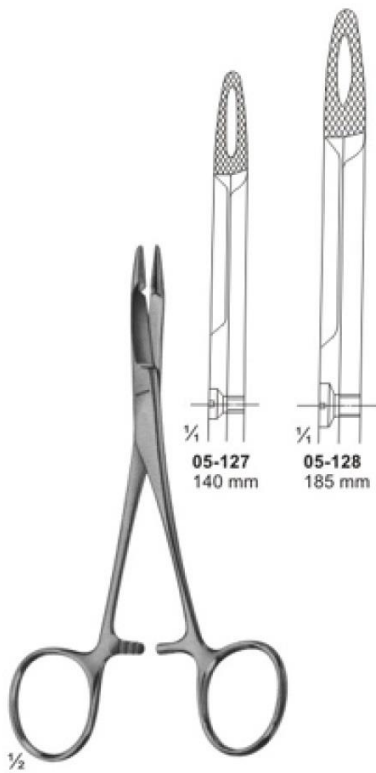

05-127 - 128
HEGAR-OLSEN
 255 mm

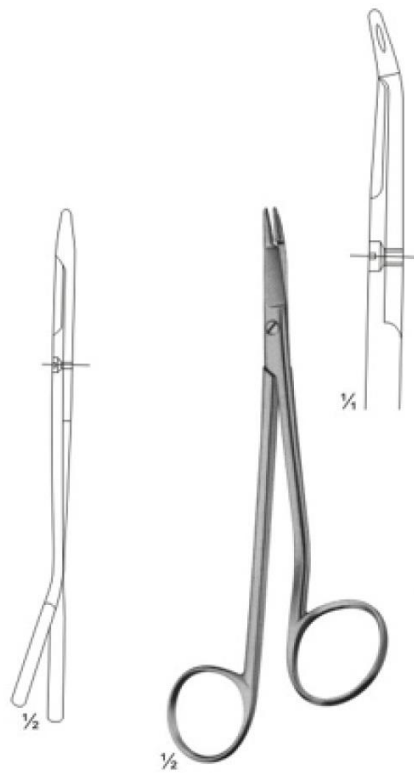

05-129
GILLIES
 150 mm



05-130
GILLIES
 160 mm

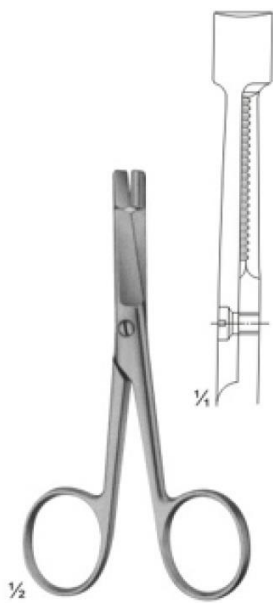

05-131
EISELSBERG
 115 mm

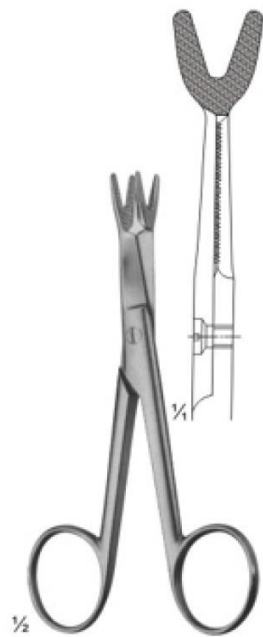

05-132
SCHOEMAKER-LOTH
 125 mm



05-133
CRILE
 150 mm



05-134
TOENNIS
 Elastic pattern for
 dura-or intestinal suture
 180 mm

Suture Instruments - Reverdin Needles

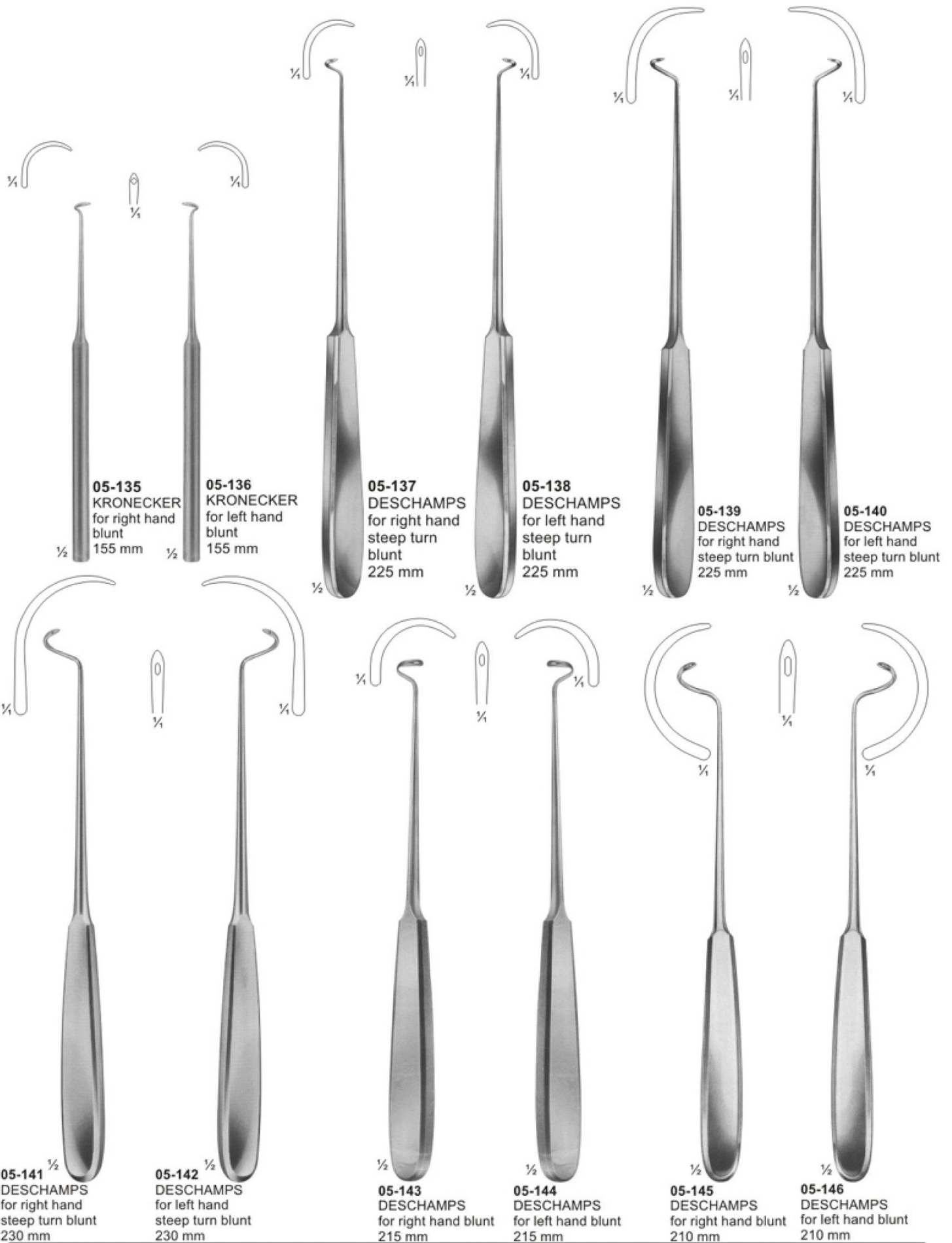



05-147 130 mm
05-148 145 mm
05-149 160 mm
 Directors

05-150
DOYEN
 145 mm
 Directors

05-151
NELATON
 160 mm
 Directors

05-152
 Director with tip
 Diam. of tip 3,3 mm
 140 mm

05-153
BRODIE
 Director with tip,
 Diam. of tip 3,5 mm
 200 mm

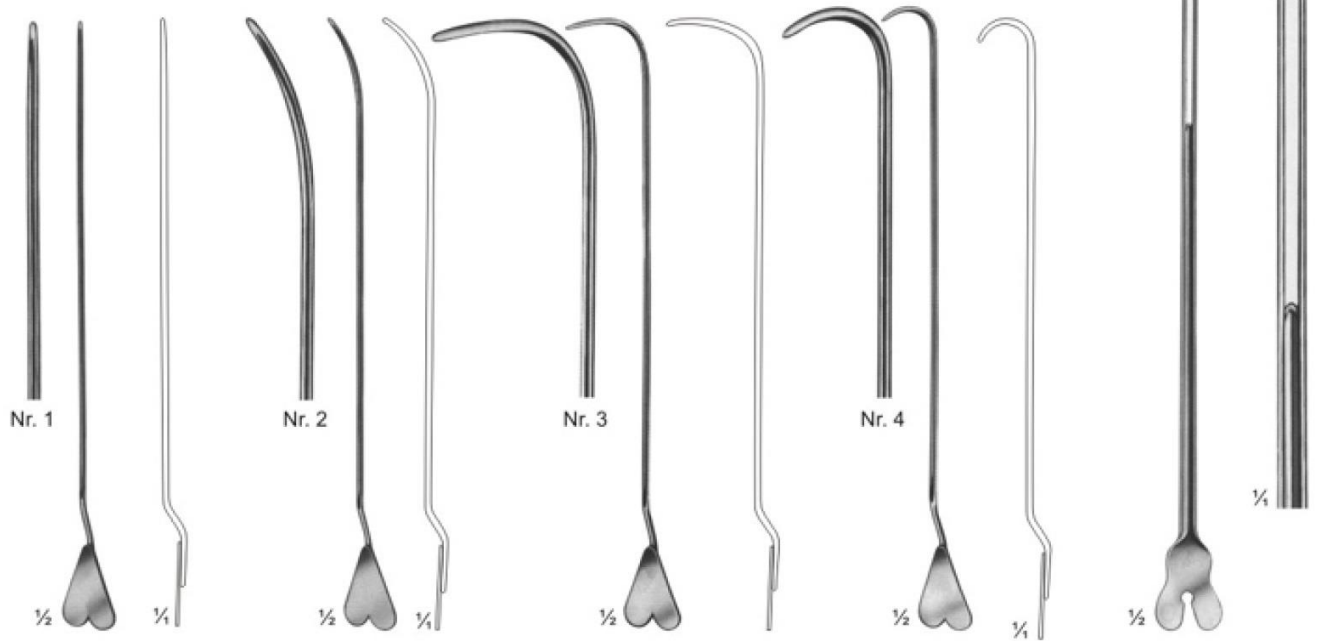

05-154
LOCKHART-MUMMERY
 165 mm

05-155
LOCKHART-MUMMERY
 165 mm

05-156
LOCKHART-MUMMERY
 165 mm

05-157
LOCKHART-MUMMERY
 165 mm

05-158
 Director with wire
 loop, malleable
 190 mm

05-199 2,5 mm
05-200 2,5 mm
05-201 3,0 mm



1/2

05-159 145 mm
05-160 160 mm
05-161 200 mm
 Probes with eye

1,5 mm



1/2

05-162
 Myrtle leaf probe
 145 mm

2,0 mm



1/2

05-163 130 mm
05-164 145 mm
05-165 160 mm
05-166 180 mm
05-167 200 mm



1/2

05-168
 Probes



1/2

05-169
 Double ended probe,
 malleable, diam. of tips
 3 mm with hole
 190 mm



05-170
 Double ended probes,
 tin, malleable,
 diam. of tips
 3,5 mm with hole
 250 mm, 300 mm



1/4

05-171
 Double ended probes,
 tin, malleable,
 diam. of tips 4 mm
 400 mm



1/2 \varnothing tip

05-172 1,5 mm
05-173 2,0 mm
05-174 2,5 mm
 300 mm

Suturing Instrument Set, Pocket Instrument Set



05-175

Suturing instruments set, in metal case
 consisting of: Scissors, curved, sharp/sharp, 115mm
 25 MICHEL clip, 16 x 3mm
 1 Delicate tissue forceps, 130mm
 1 Scalpel, bellied
 1 MATHIEU needle holder, 140mm
 1 Perforated metal case, stainless
 containing:
 1 Suture needle
 1 item 1 item



05-176

Pocket instrument set, in metal case
 consisting of:

Bottom tray

1 MATHIEU needle holder, 140mm
 1 MICHEL clip forceps, combined
 1 Myrtle leaf probe, 130mm
 1 Sharp double curette
 1 Skin hook
 1 Detachable scalpel handle, no.4
 1 Perforated metal case, containing
 6 Scalpel blades
 1 Perforated metal case,
 stainless, containing
 1 Suture needle
 1 item
 1 item

Top tray

1 Tissue forceps, 130mm
 1 KOCHER haemostatic forceps, 130mm
 1 Straight surgical scissors, 130mm
 1 Dissecting forceps, 130mm
 1 FEILCHENFELD splinter forceps, 115mm
 25 MICHEL clip, 16 x 3mm
 1 Flacon of suture skin, sterile in alcohol



05-177

Pocket instrument set, in metal case
 consisting of:

Bottom tray







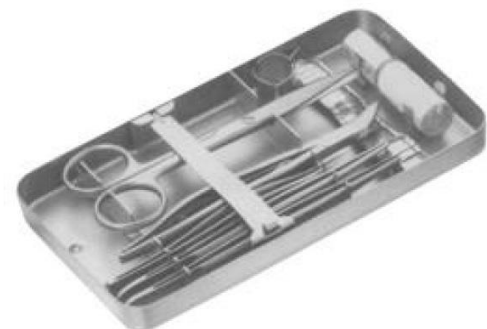



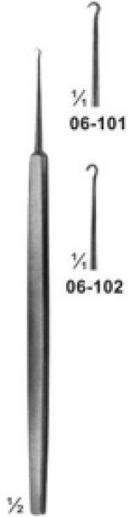
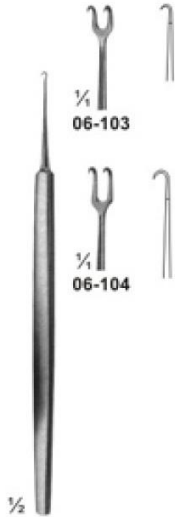

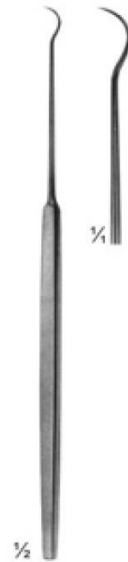
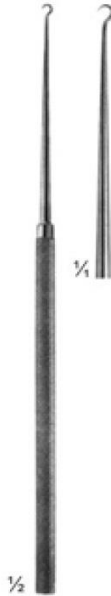
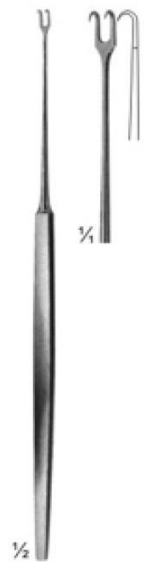
1 MAYO-HEGER needle holder, 150mm
 1 MICHEL clip forceps, combined
 1 Myrtle leaf probe, 130mm
 1 Sharp double curette
 1 Skin hook
 1 Detachable scalpel handle, no. 4
 1 Perforated metal case, consisting
 6 Scalpel blades
 1 Perforated metal case, stainless, consisting:
 1 Suture needle
 1 item, & 1 item

Top tray

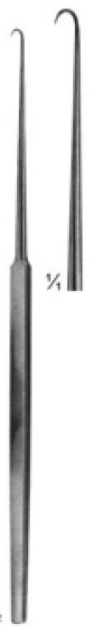
1 Tissue forceps, 130mm
 1 CRILE haemostatic forceps, 140mm
 1 Straight surgical scissors, 130mm
 1 Dissecting forceps, 130mm
 1 FEILCHENFELD splinter forceps, 115mm
 25 MICHEL clip, 16 x 3mm
 1 Flacon of suture silk, sterile in alcohol



Fine Wound Retractors (Dura- and Skin Retractors)

 <p>1/4 06-101 1/4 06-102</p>	 <p>1/4 06-103 1/4 06-104</p>	 <p>1/4 06-105 1/4 06-106 1/4 06-107</p>	 <p>1/4</p>	 <p>1/4</p>	 <p>1/4</p>	 <p>1/4</p>		
<p>06-101 Sharp 06-102 Blunt GRAEFE 125 mm</p>	<p>06-103 125 mm 06-104 130 mm sharp GUTHRIE</p>	<p>06-105 130 mm 06-106 135 mm sharp ROLLET 06-107 135 mm blunt</p>	<p>06-108 FRAZIER Dura retractors 130 mm</p>	<p>06-109 TONNIS Dura retractors 150 mm</p>	<p>06-110 KILNER 160 mm</p>	<p>06-111 FREER 150 mm</p>		
 <p>1/4</p>	 <p>1/4</p>	 <p>1/4</p>	 <p>1/4</p>	 <p>1/4</p>	 <p>1/4</p>	 <p>1/4 06-117 1/4 06-118 3 mm 1/4 06-119 6 mm 1/4 06-120 8 mm</p>	 <p>1/4 06-121 1/4 06-122</p>	 <p>7 X 12 mm 3 X 11 mm 8 X 12 mm</p>
<p>06-112 MULLER 150 mm</p>	<p>06-113 MULLER 150 mm</p>	<p>06-114 COTTLE 160 mm</p>	<p>06-115 COTTLE 160 mm</p>	<p>06-116 JAEGER 135 mm</p>	<p>06-117 - 120 JOSEPH 165 mm</p>	<p>06-121 - 122 GILLIES 180 mm</p>	<p>06-123 KILNER sharp 80 mm</p>	<p>06-124 CONVERSE blunt 120 mm</p>

Retractors With treangle handle

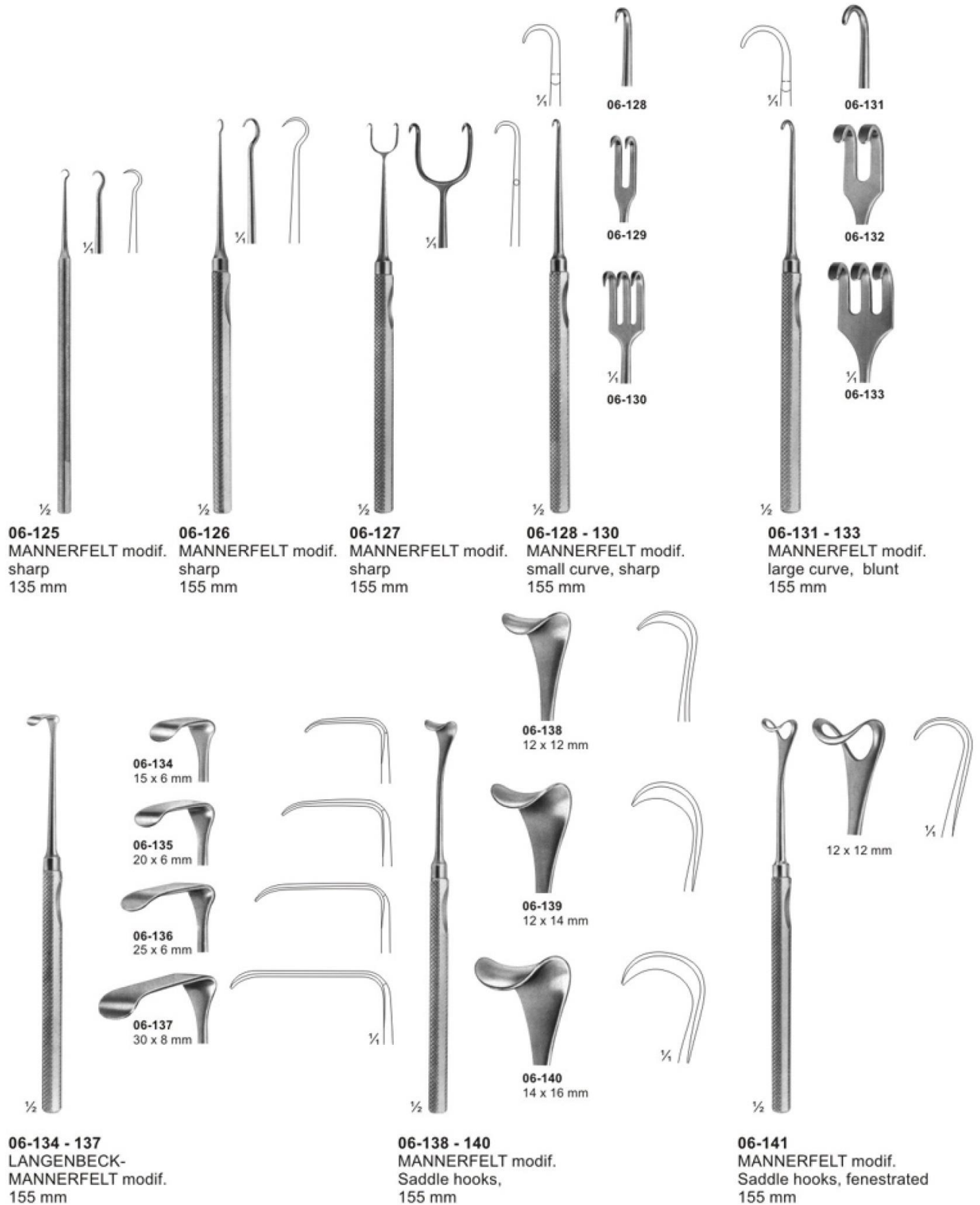

Retractors

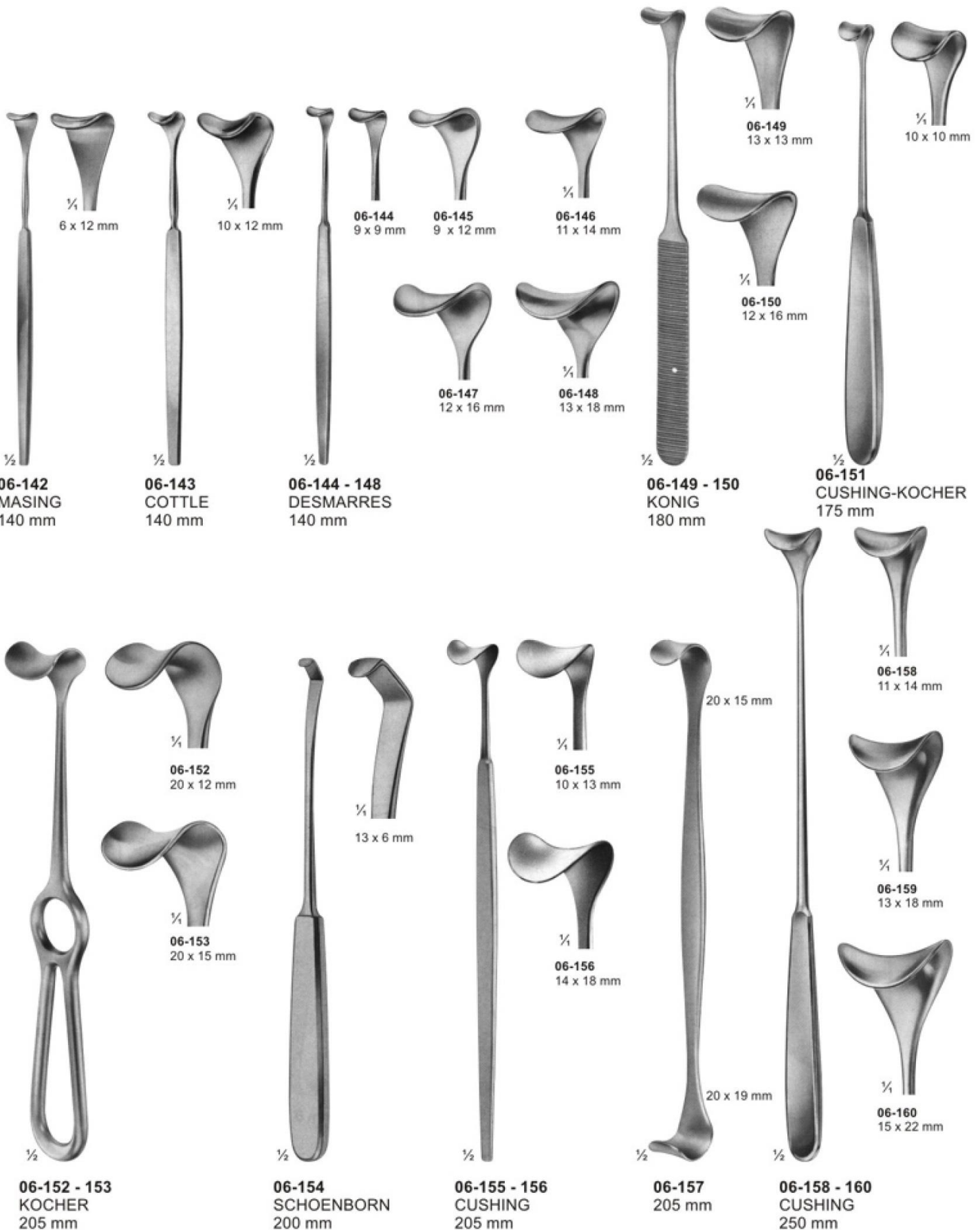

Retractors

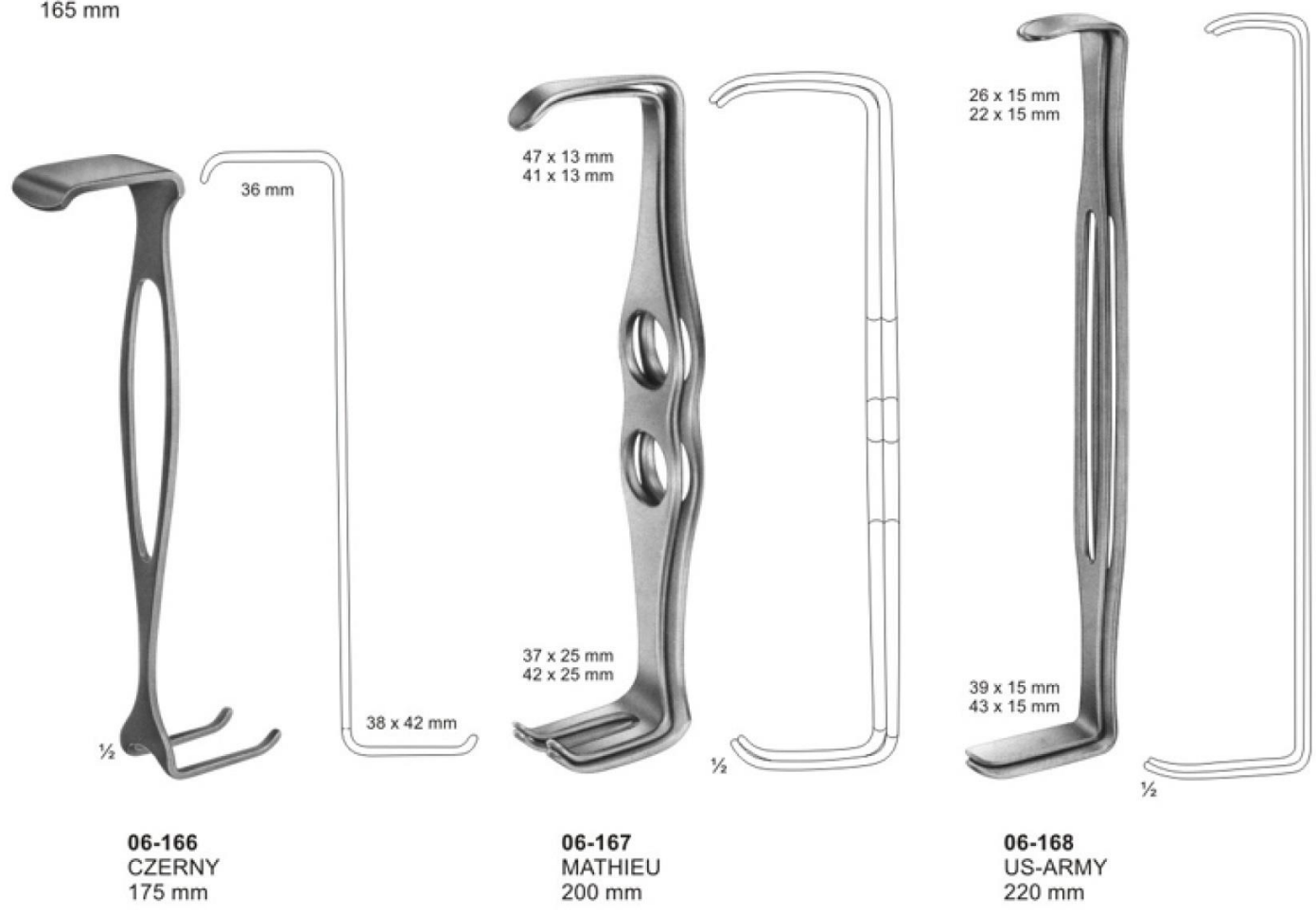
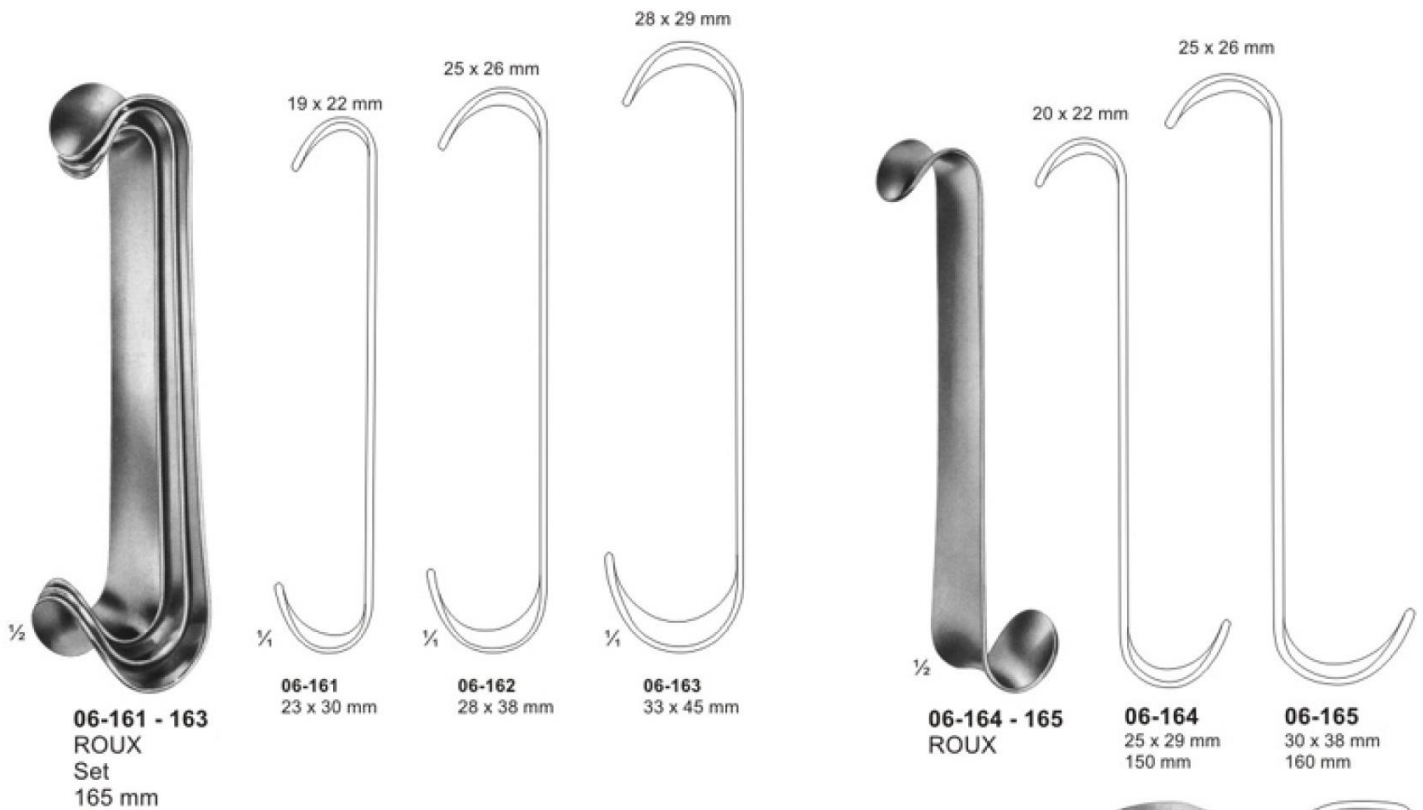

Bone Retractors and Retractors



06-169
KOCHER
 sharp
 205 mm



06-170
KOCHER
 sharp
 220 mm



06-171
KOCHER
 sharp
 220 mm



06-172
VOLKMANN
 blunt
 220 mm



06-173
VOLKMANN
 sharp
 220 mm



06-174 - 181
VOLKMANN
 225 mm

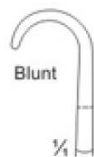
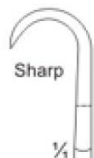

06-174
 9 x 8 mm



06-175
 9 x 13 mm



06-176
 9 x 19 mm



06-177
 9 x 29 mm



06-178
 8,5 x 8 mm



06-179
 8,5 x 13 mm



06-180
 8,5 x 19 mm



06-181
 8,5 x 29 mm

Retractors

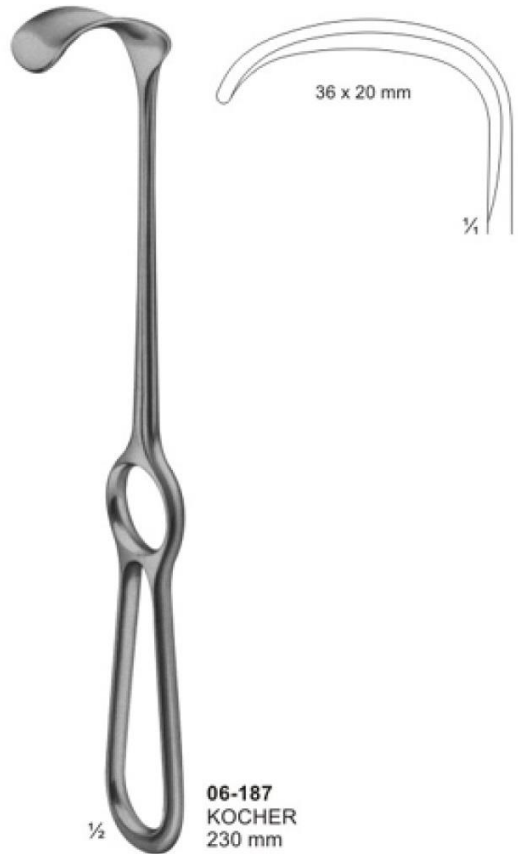
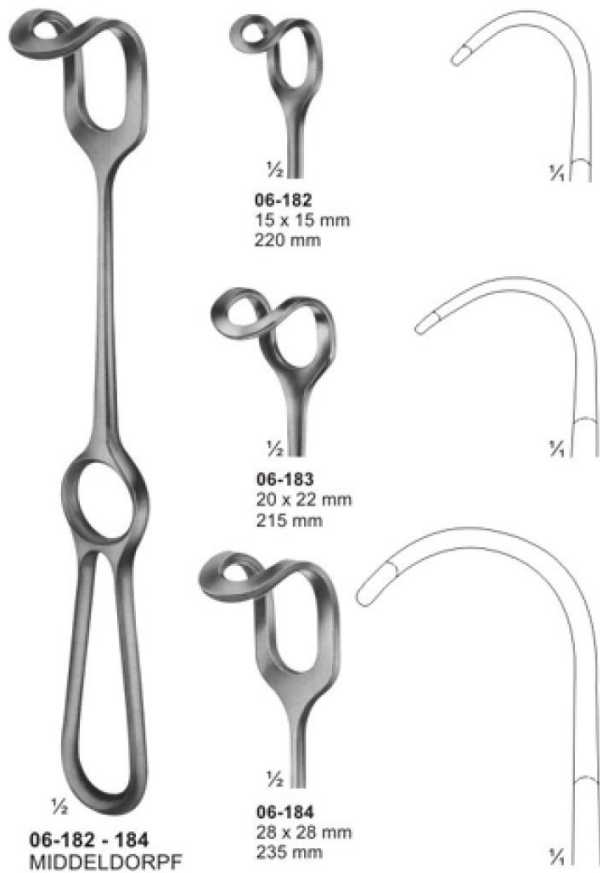



06-188 - 194
 BRUNNER
 275 mm

- 06-188** 80 x 20
- 06-189** 100 x 25
- 06-190** 120 x 25
- 06-191** 130 x 30
- 06-192** 140 x 30
- 06-193** 160 x 30
- 06-194** 180 x 30

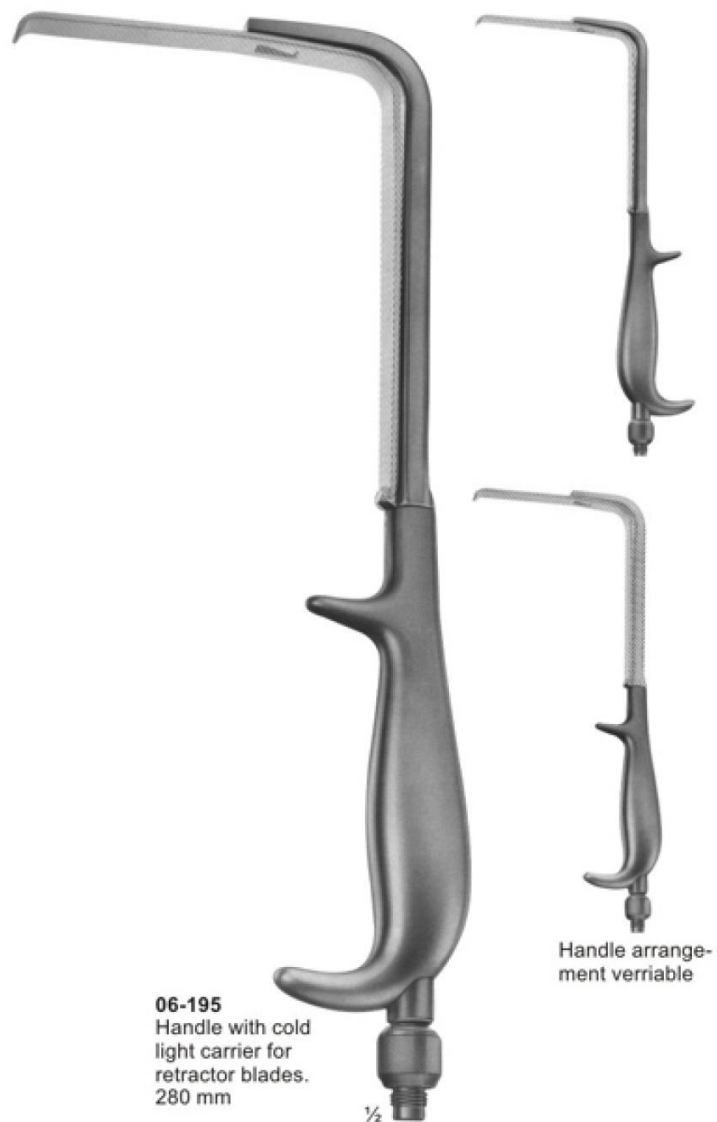

06-195
 Handle with cold
 light carrier for
 retractor blades.
 280 mm

Retractors, Lung Spatulas



Retractors for deep surgery (Abdominal Retractors)

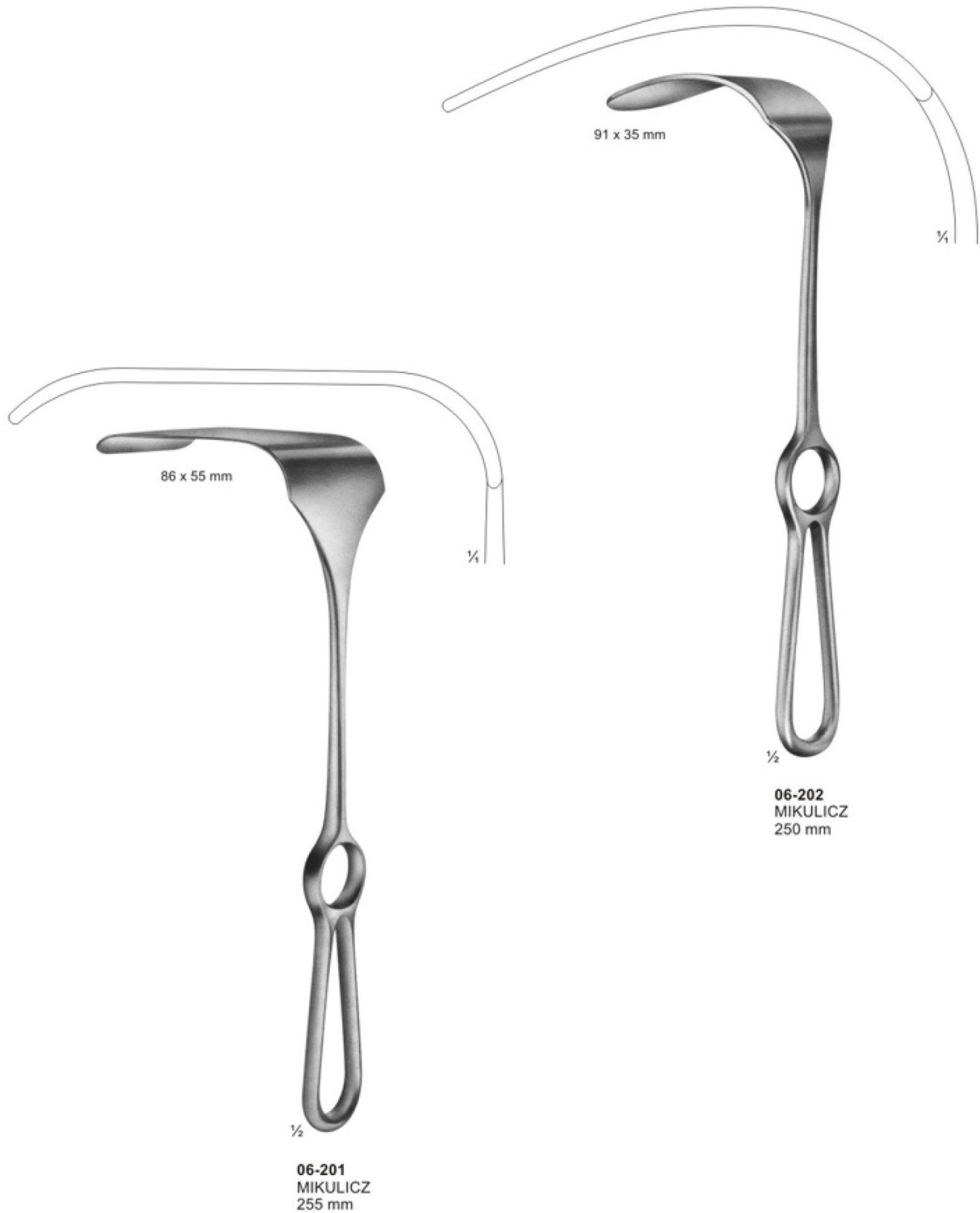

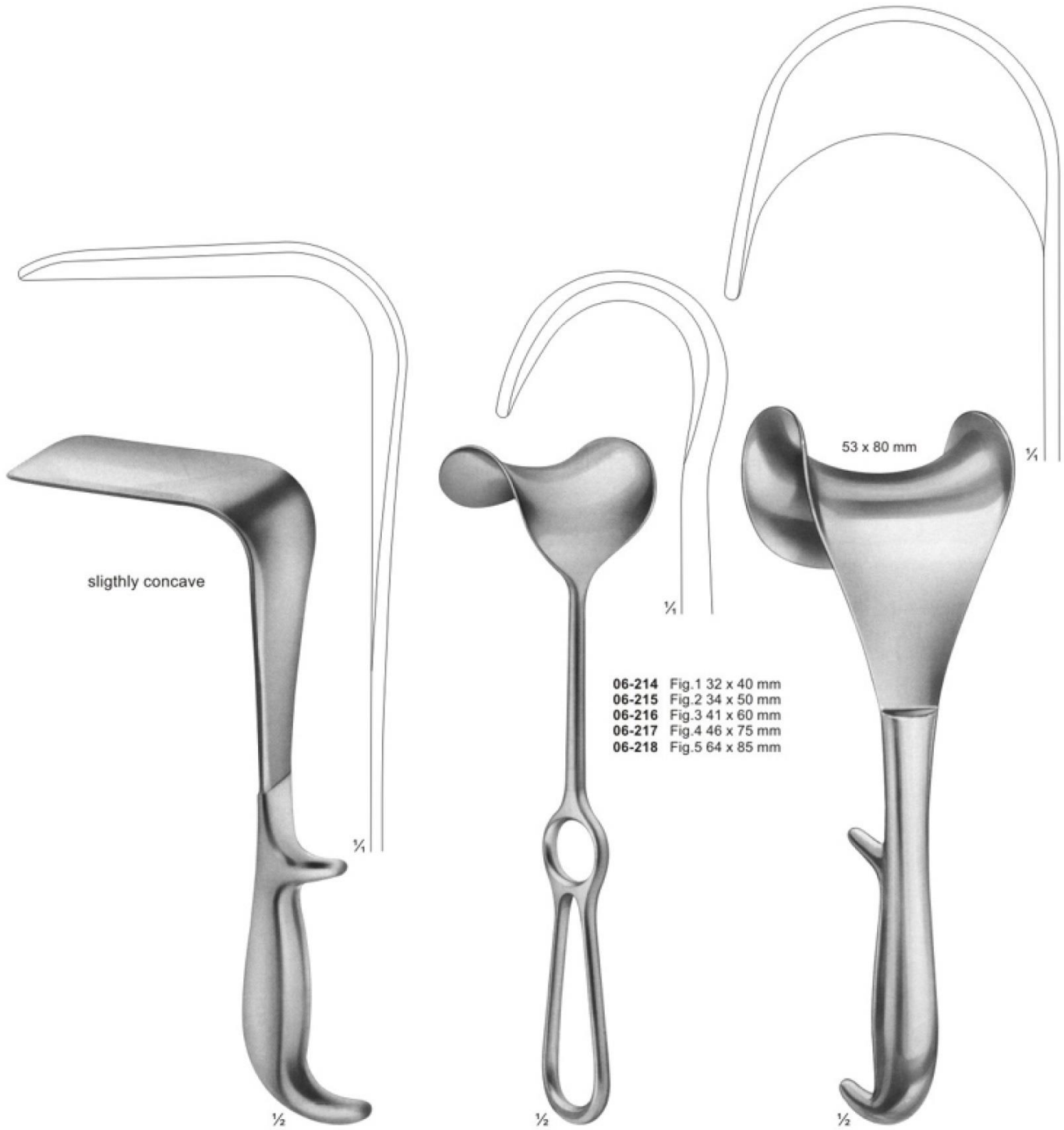

- 06-214 Fig.1 32 x 40 mm
- 06-215 Fig.2 34 x 50 mm
- 06-216 Fig.3 41 x 60 mm
- 06-217 Fig.4 46 x 75 mm
- 06-218 Fig.5 64 x 85 mm

06-203 - 213
DOYEN
 240 mm

06-214 - 218
FRITSCH
 240 mm

06-219
DOYEN
 250 mm

	width of blades	35 mm, 45 mm, 60 mm
length of blades	06-203 , 06-204 , 06-205	62 mm
	06-206 , 06-207 , 06-208	92 mm
	06-209 , 06-210 , 06-211	122 mm
	06-212 , 06-213	160 mm

Abdominal- and Intestinal Spatulas

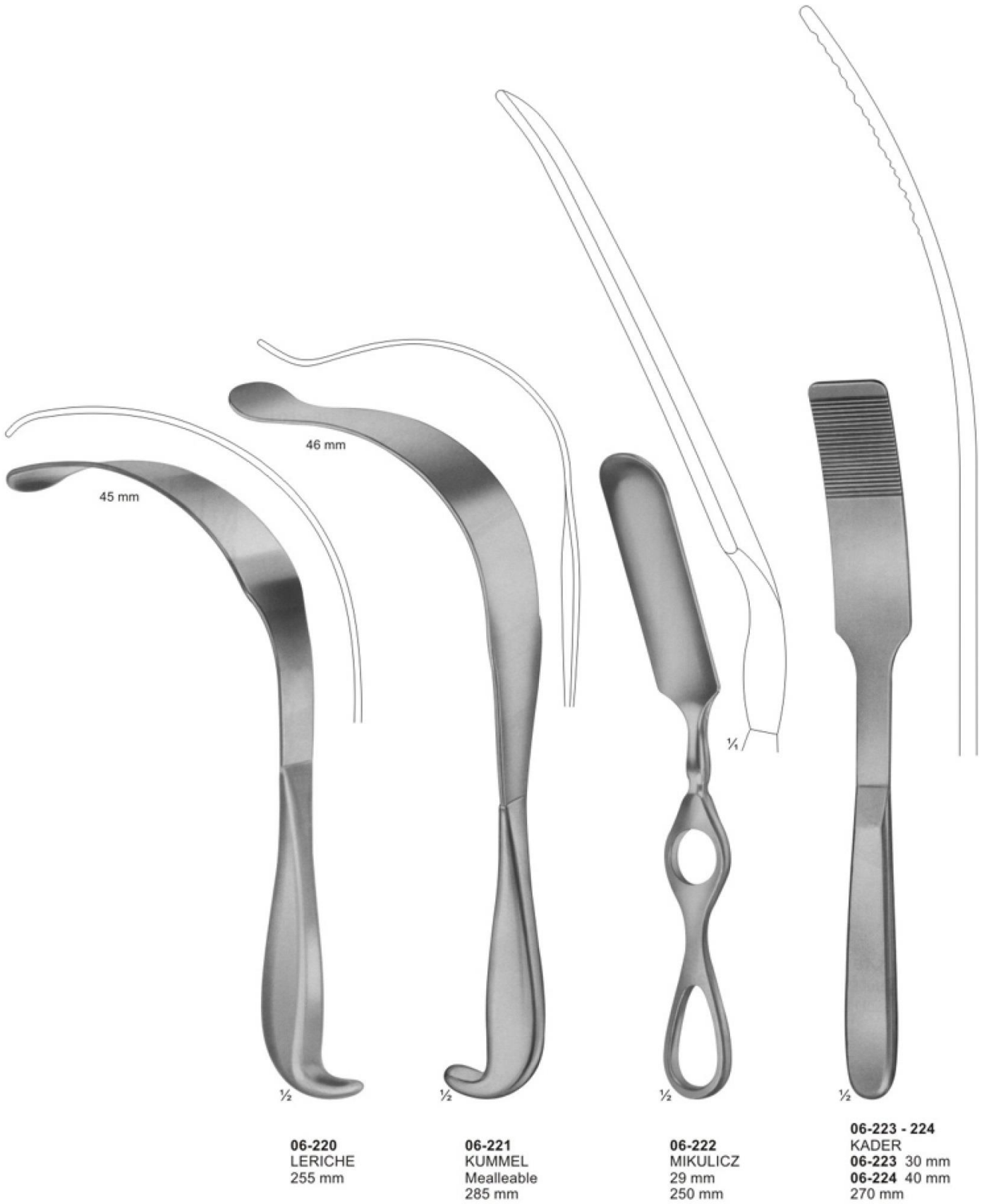

Self-Retaining Retractors

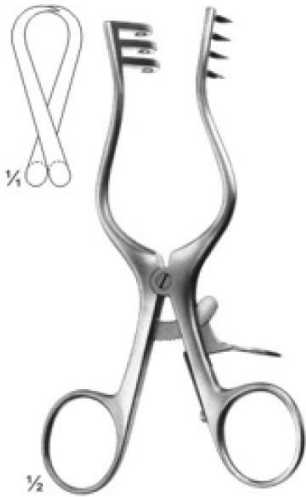

06-225
WEITLANER
 sharp
 130 mm

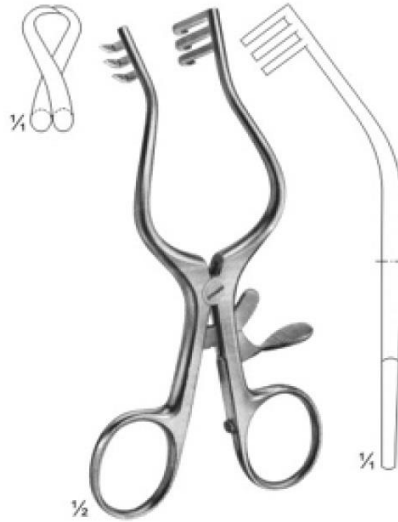

06-226
WULLSTEIN
 sharp
 130 mm

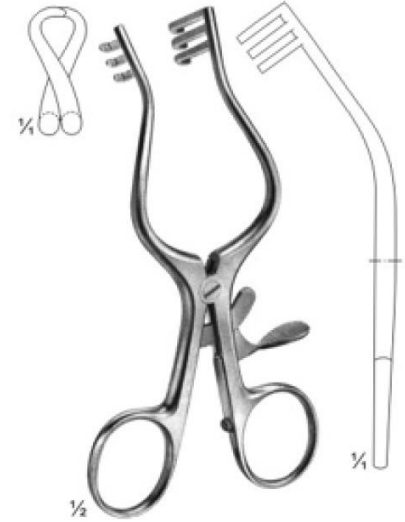

06-227
WULLSTEIN
 blunt
 130 mm



06-228
WEITLANER
 sharp
 165 mm



06-229
PLESTER
 blunt
 110 mm



06-230
PERKINS
 130 mm

Special Retractors



06-231
JOLL (FRIEDMAN)
 Thyroid- and vaginal retractor
 155 mm

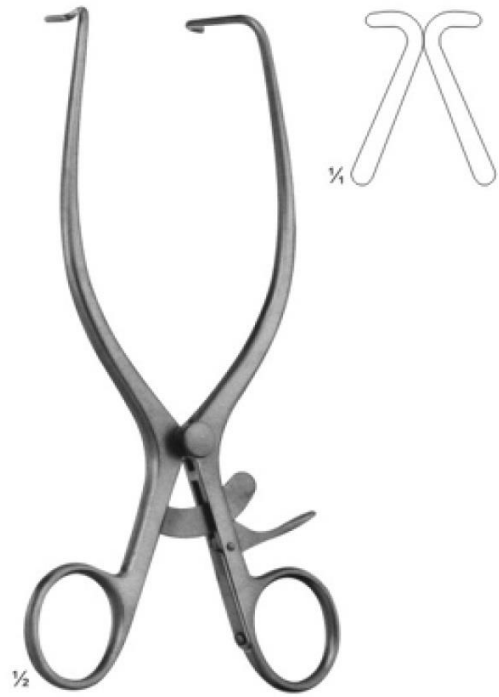

06-232
JACKSON BURROWS
 Retractor, blunt
 185 mm



06-233
GELPI
 Vaginal retractor
 135 mm

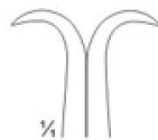

06-234
GELPI
 Skin- and vaginal retractor
 175 mm

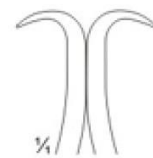

06-235
DE BAKEY
 Femur retractor
 145 mm

Lamina Spreaders



06-236
CLOWARD
155 mm



06-237
CLOWARD
135 mm



06-238
INGE
170 mm

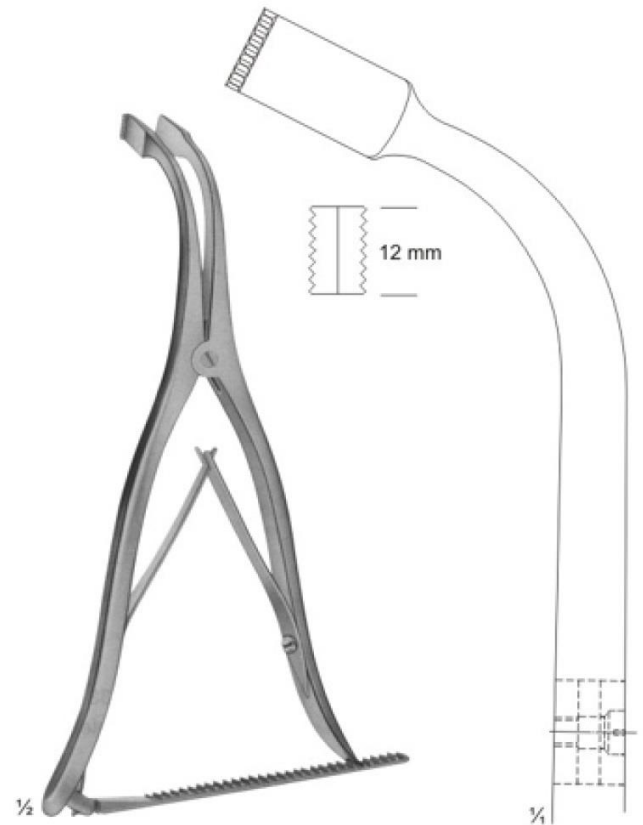

06-239
INGE
275 mm

Abdominal Retractors



06-240
GOSSET
 Blades: 38 mm deep

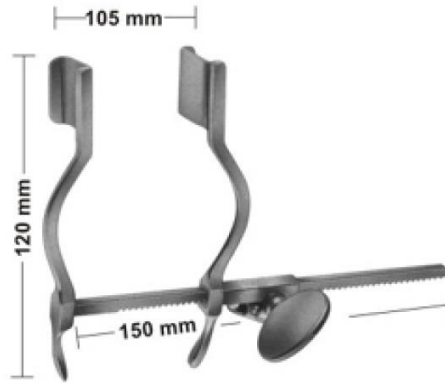

06-241
HERTZLER
 Blades 20 X 25 mm

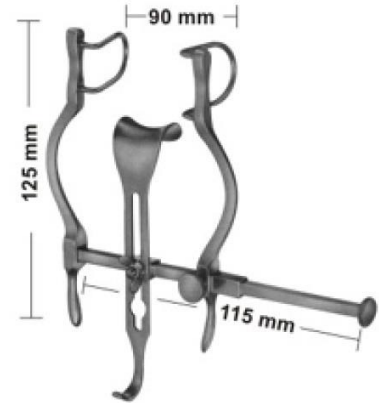

06-242
BALFOUR-BABY
 Lateral blades 27 mm deep
 Center blade 21x24 mm

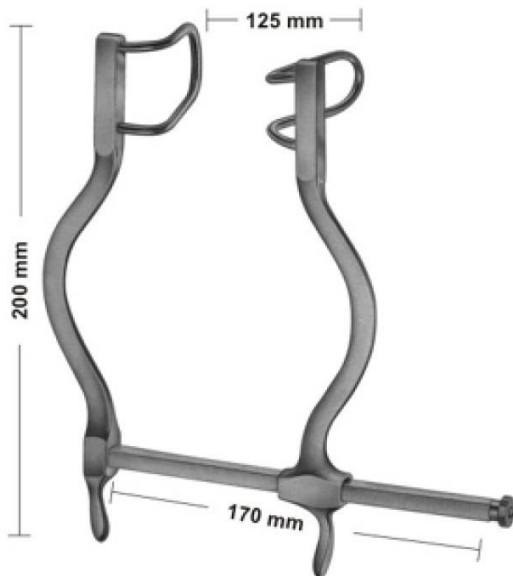

06-243
GOSSET
 Blades: 55mm deep

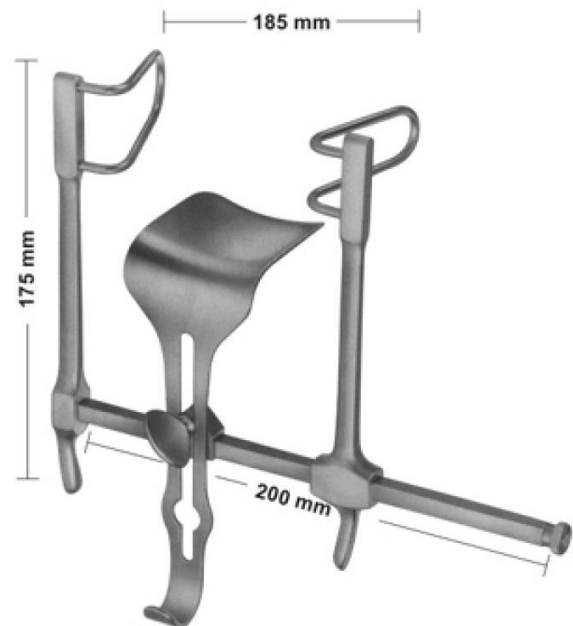

06-244
GOSSET
 Lateral blades 58 mm deep
 Center blade 59 x 57 mm

Abdominal Retractors

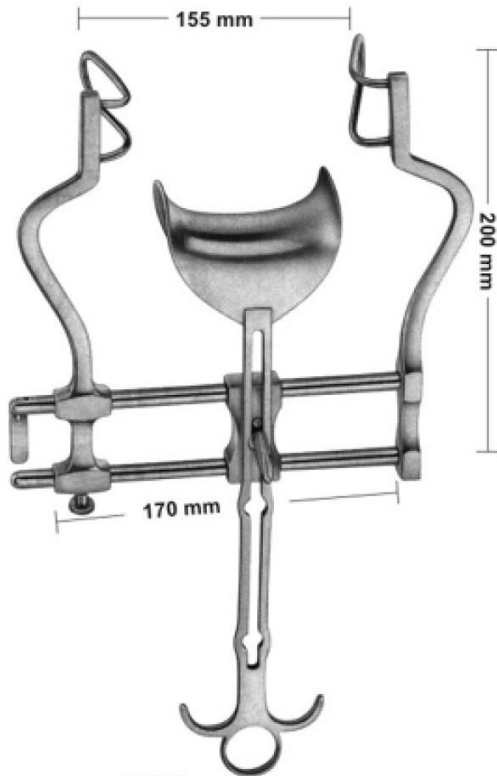

06-245
BALFOUR
 Lateral blades 60 mm deep
 Center blade 47 x 80 mm

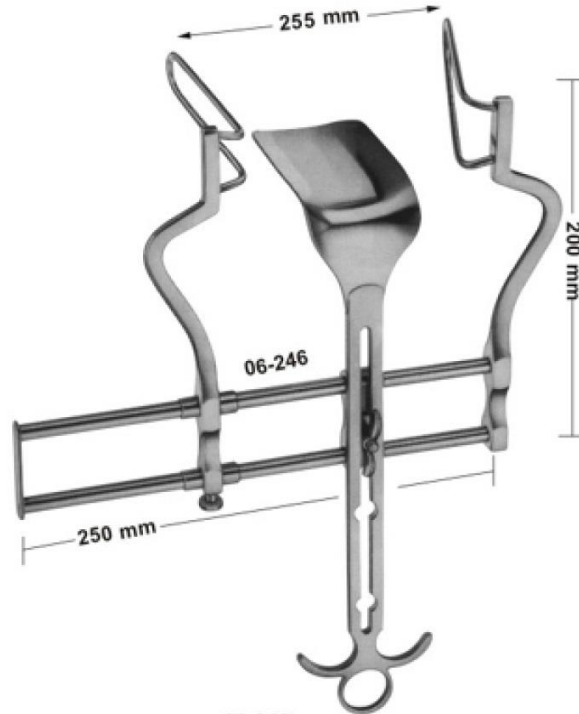

06-246
BALFOUR
 Lateral blades 105 mm deep
 Center blade 107x 59 mm

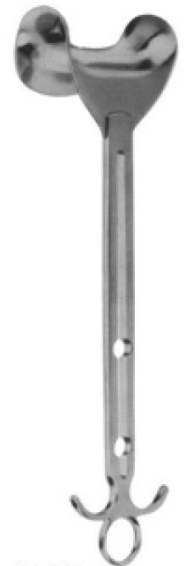

06-247
 Center blade only
 54x80 mm

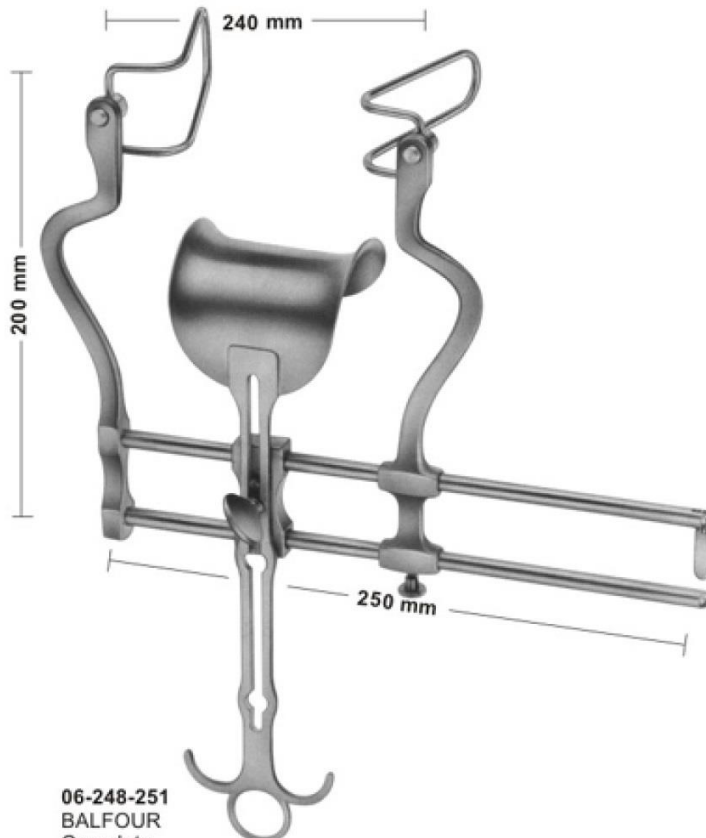

06-248-251
BALFOUR
 Complete
 Spreader only **06-248** **06-249** **06-250** **06-251**
 Lateral blades 50 mm 60 mm 75 mm 90 mm
 Center blade 47 x 80 mm 62x76 mm 80x80 mm 80x80 mm



Lateral blades
06-252 50 mm deep
06-253 60 mm deep
06-254 75 mm deep
06-255 90 mm deep
 Sales Unit of blades:PR = pair

Organ-, Tissue and Intestinal Grasping Forceps

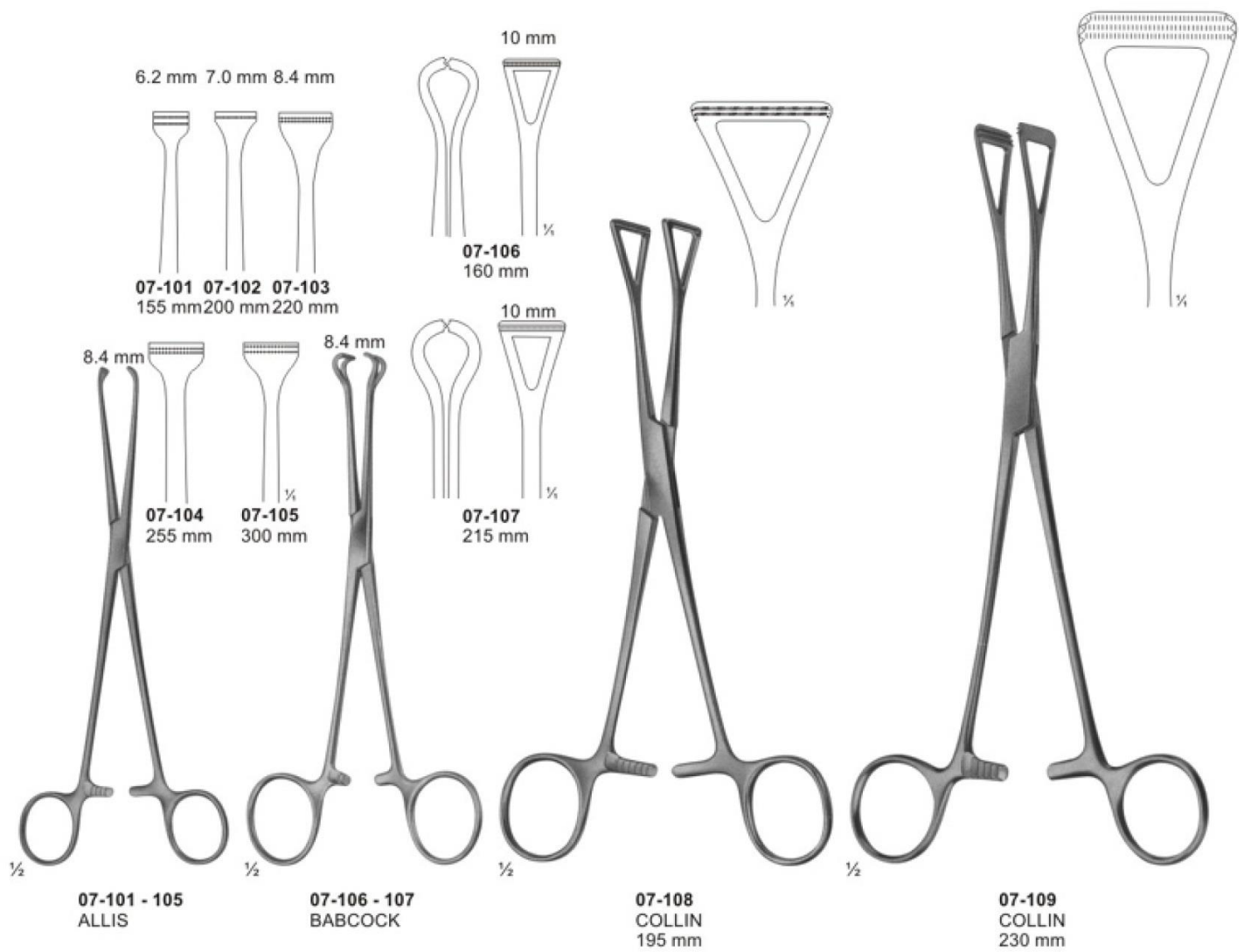

Intestinal Clamps, soft elastic

ATRAUMATA

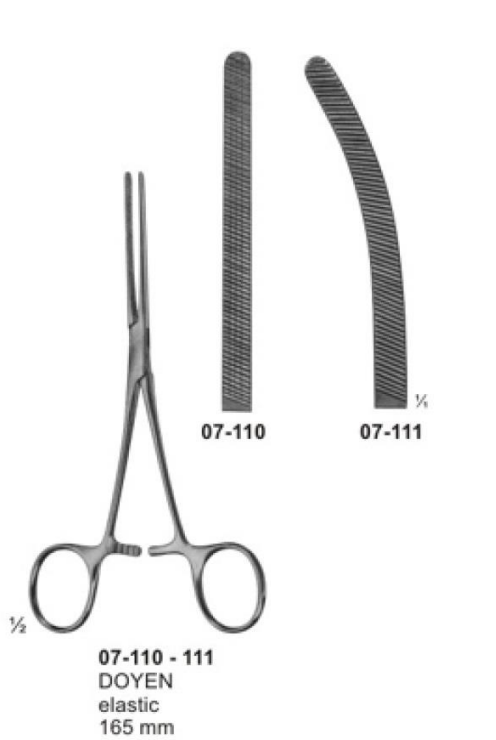

ATRAUMATA

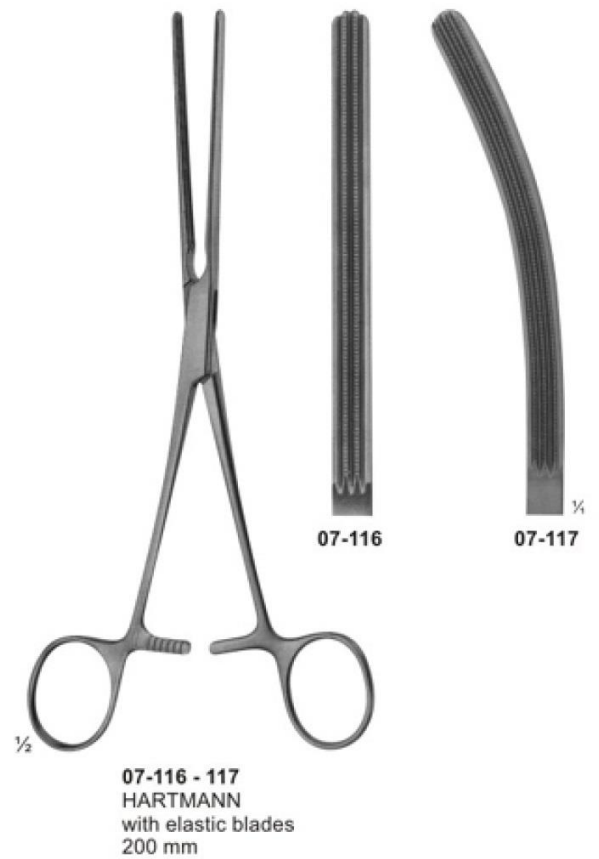
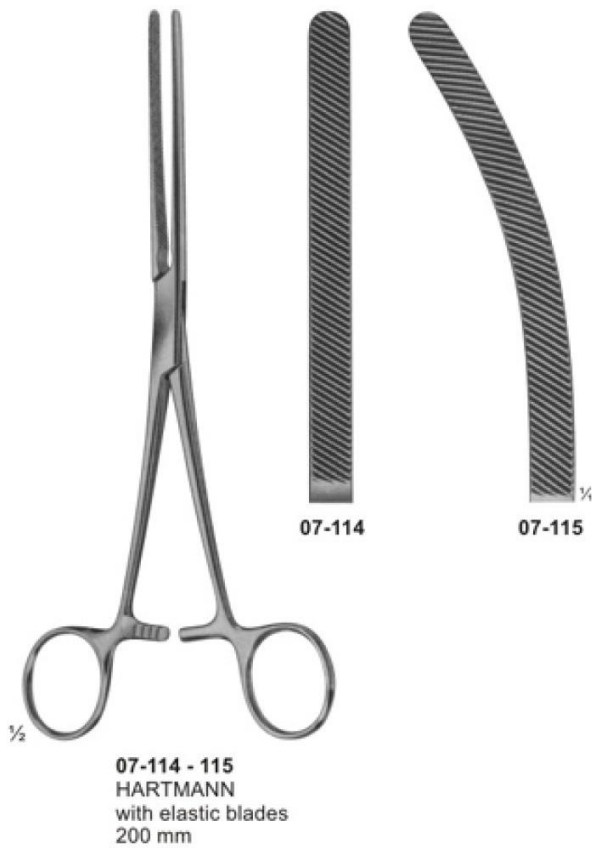

Intestinal and Pylorus Clamps



1/2
07-118
PAYR
Intestinal clamp
light pattern,
for children
180 mm

1/2
07-119
PAYR
200 mm

1/2
07-120
PAYR
275 mm

1/2
07-121
PAYR
Pylorus clamp
315 mm

ATRAUMATA
Sigmoid Anastomosis Forceps

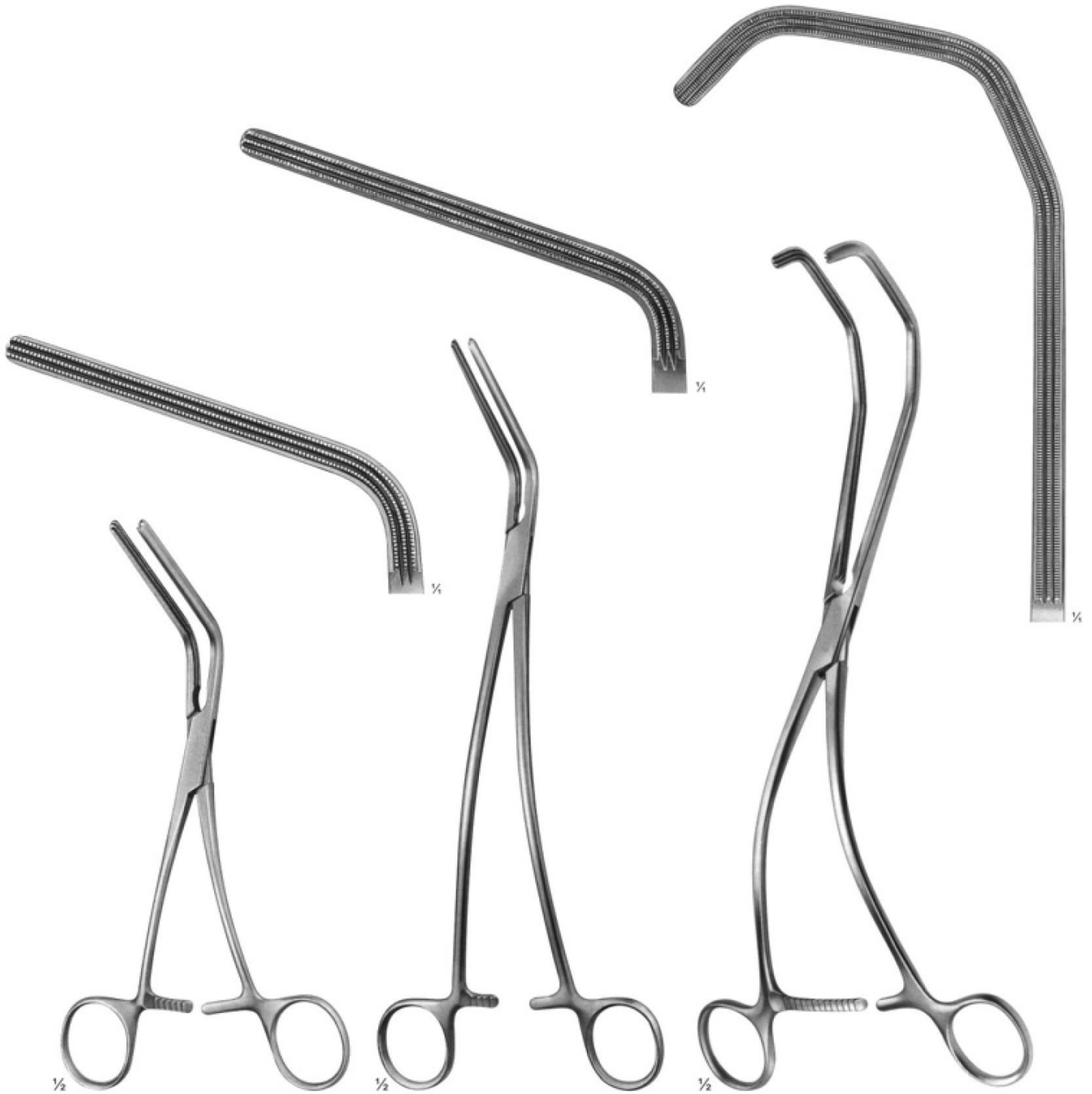

07-222
MORRIS
175 mm

07-223
DE BAKEY
(MORRIS modif.)
240 mm

07-224
KERSTING
270 mm

Rectal Specula

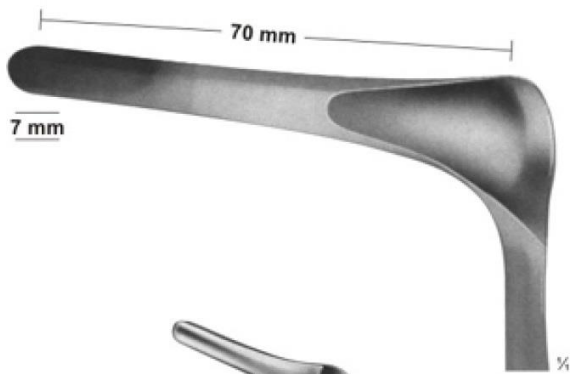

08-101
KILLIAN
 for children
 145 mm



08-102
SIMS
 160 mm



08-103
SIMS
 160 mm

Anuscopes-Sphincteroscopes



08-104
IVES-FANSLER
 Anuscops
 145 mm
 Ø24mm



08-105
KELLY
 Sphincteroscope
 160 mm
 Ø21mm



08-106
KELLY
 Sphincteroscope
 160 mm
 Ø27mm

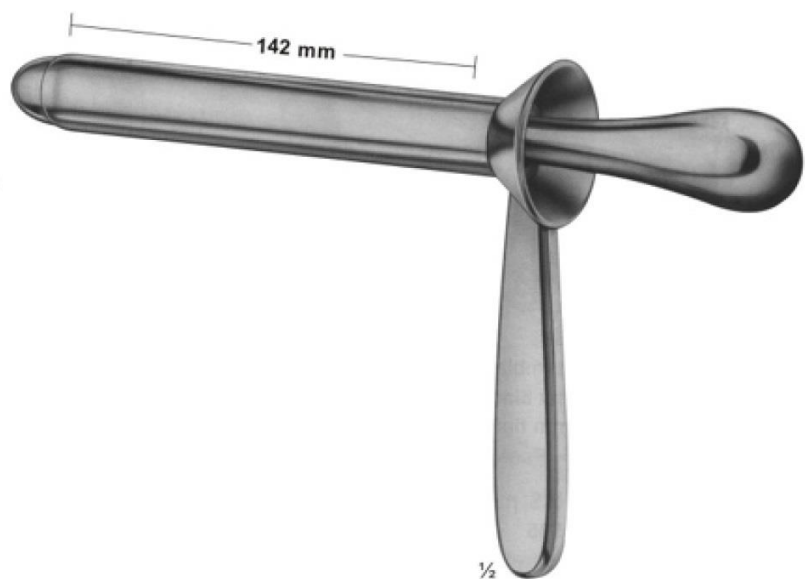

08-107
KELLY
 Proctoscope
 140 mm
 Ø22mm

Biopsy forceps for rectum

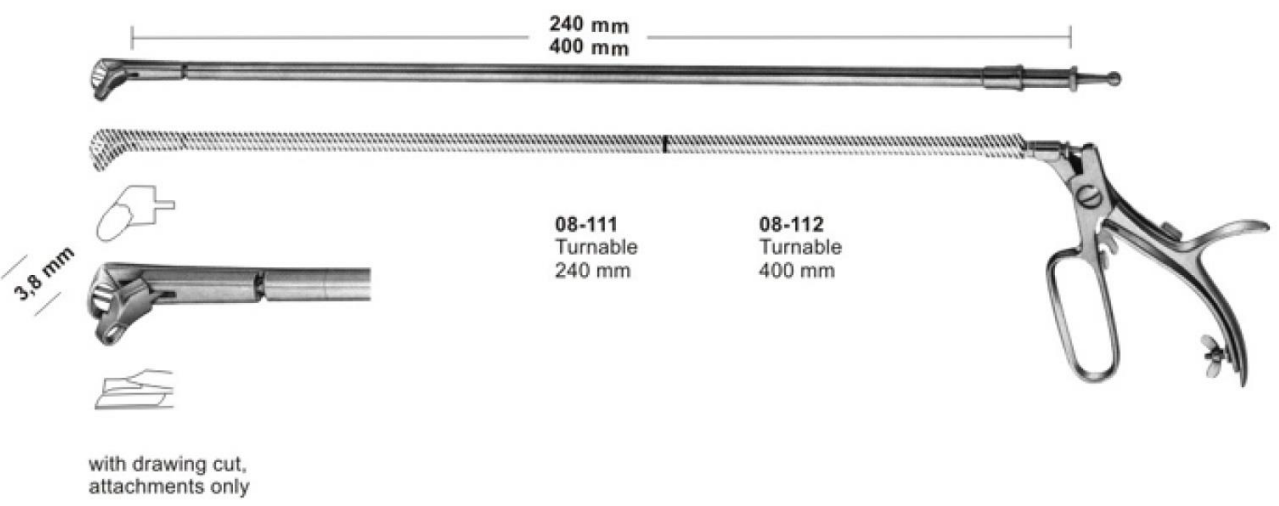
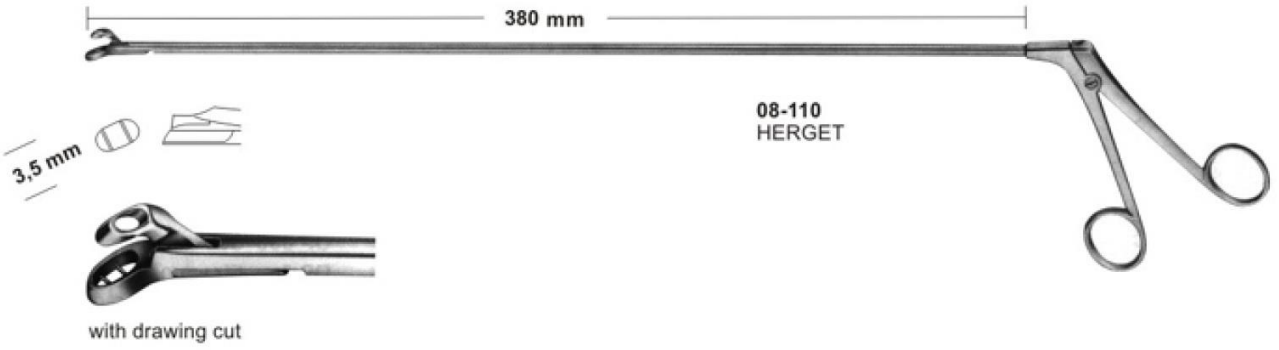
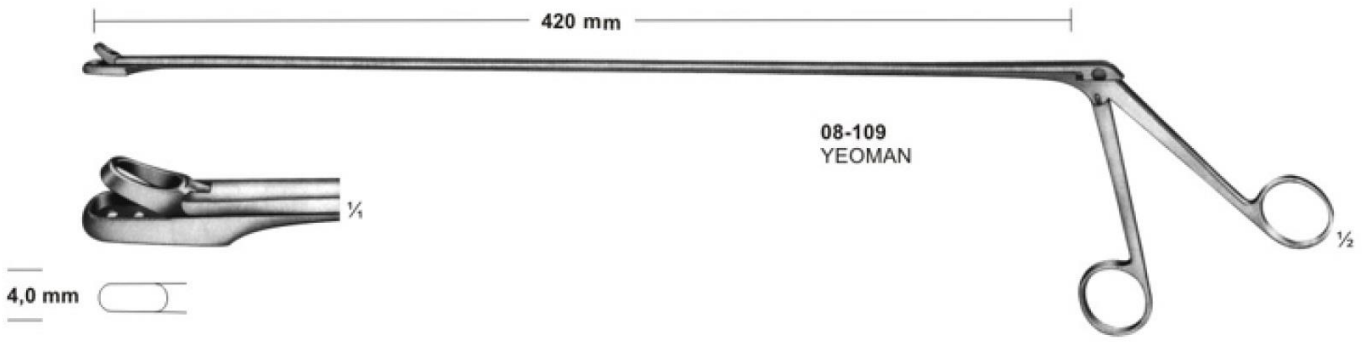
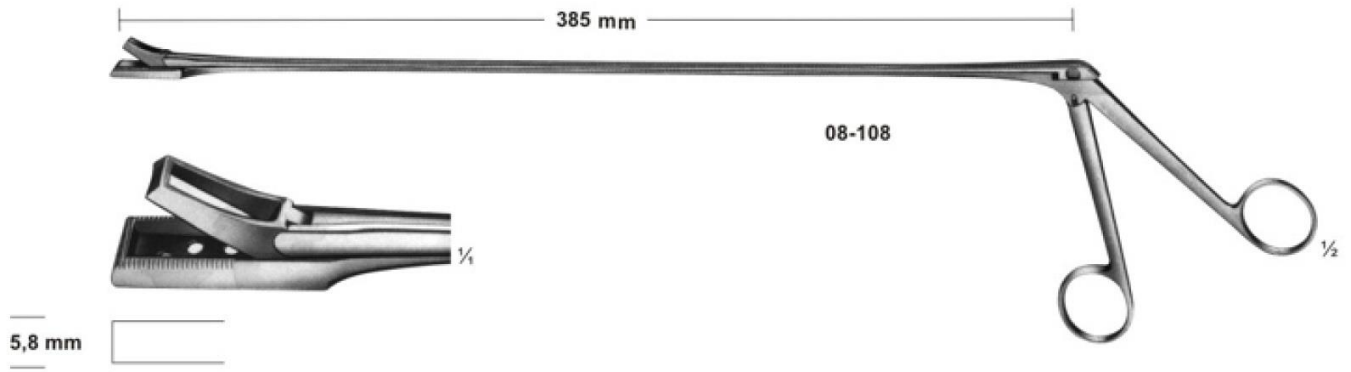

Haemorrhoidal Forceps

ATRAUMATA

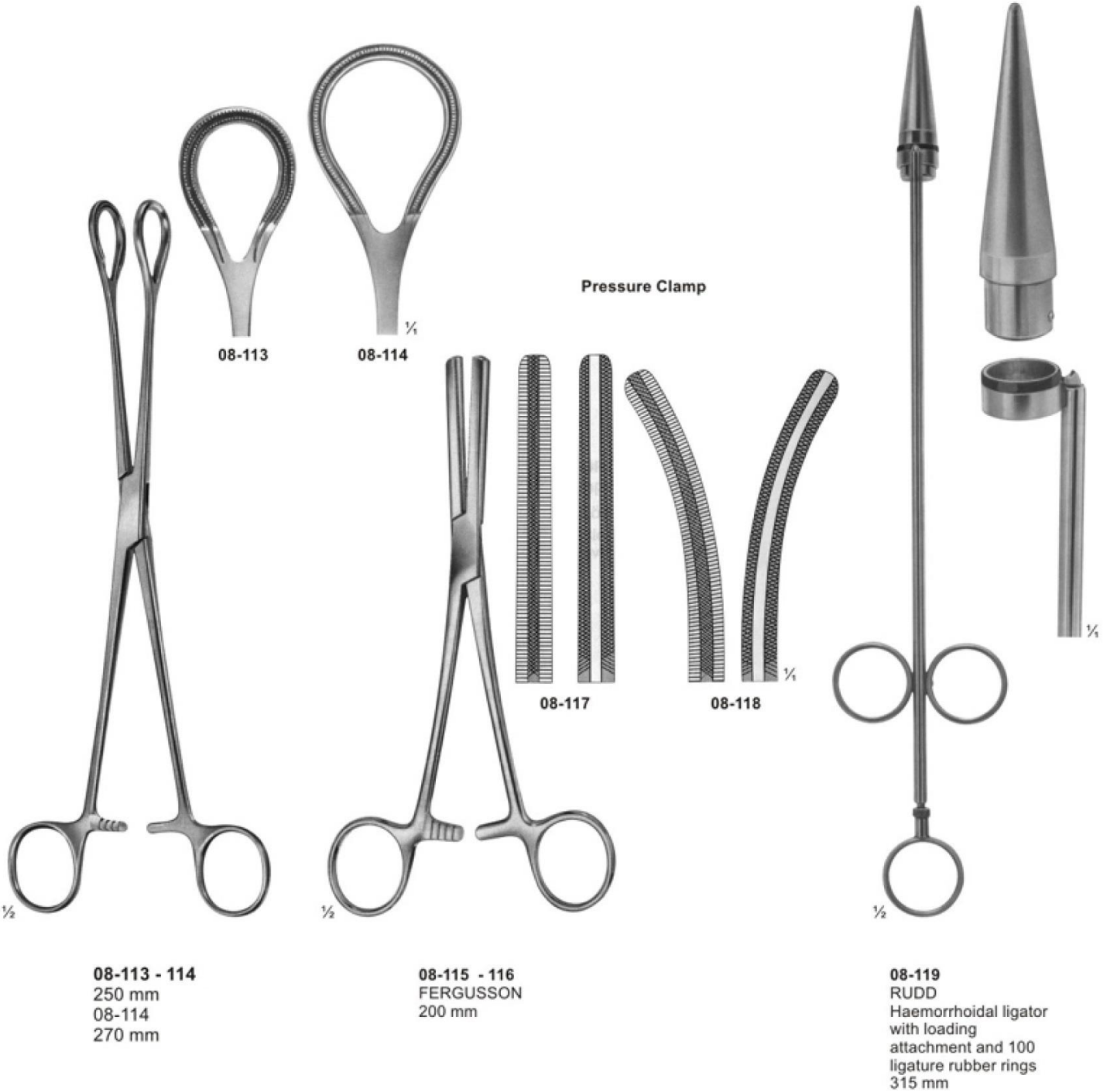

Gall Duct Forceps



08-120
LOWER
180 mm



08-121
LAHEY (SWEET)
190 mm



08-123
LAHEY
220 mm



08-124
DESJARDINS
Gall duct-and cystic forceps
210 mm



08-125
NISSEN
Gall duct-and cystic forceps
215 mm

Gall Duct Dilators and Gall Stone Scoops

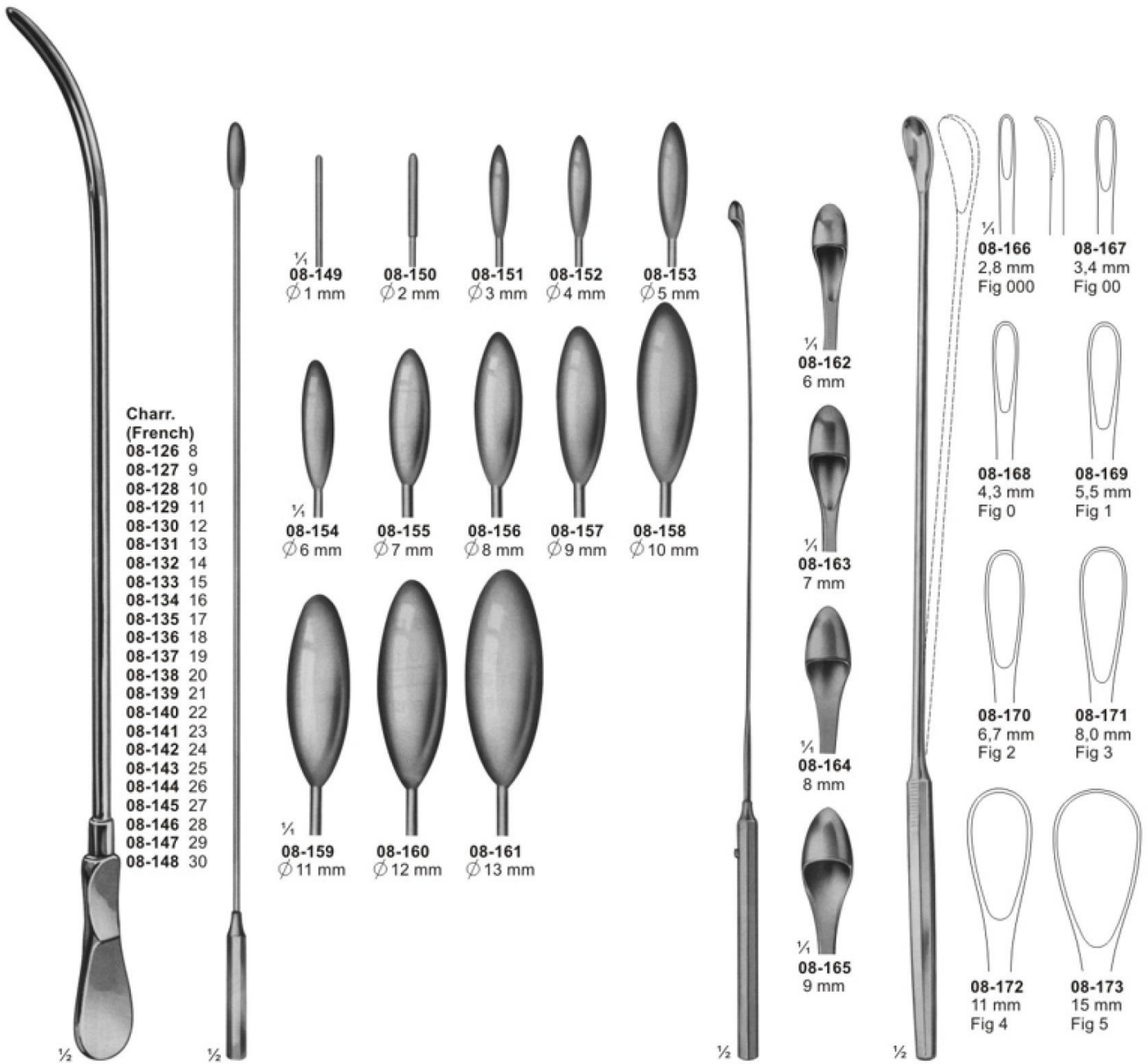

**Charr.
(French)**
 08-126 8
 08-127 9
 08-128 10
 08-129 11
 08-130 12
 08-131 13
 08-132 14
 08-133 15
 08-134 16
 08-135 17
 08-136 18
 08-137 19
 08-138 20
 08-139 21
 08-140 22
 08-141 23
 08-142 24
 08-143 25
 08-144 26
 08-145 27
 08-146 28
 08-147 29
 08-148 30

1/4
08-149
 Ø 1 mm

1/4
08-150
 Ø 2 mm

1/4
08-151
 Ø 3 mm

1/4
08-152
 Ø 4 mm

1/4
08-153
 Ø 5 mm

1/4
08-154
 Ø 6 mm

1/4
08-155
 Ø 7 mm

1/4
08-156
 Ø 8 mm

1/4
08-157
 Ø 9 mm

1/4
08-158
 Ø 10 mm

1/4
08-159
 Ø 11 mm

1/4
08-160
 Ø 12 mm

1/4
08-161
 Ø 13 mm

1/4
08-162
 6 mm

1/4
08-163
 7 mm

1/4
08-164
 8 mm

1/4
08-165
 9 mm

1/4
08-166
 2,8 mm
 Fig 000

1/4
08-167
 3,4 mm
 Fig 00

1/4
08-168
 4,3 mm
 Fig 0

1/4
08-169
 5,5 mm
 Fig 1

1/4
08-170
 6,7 mm
 Fig 2

1/4
08-171
 8,0 mm
 Fig 3

1/4
08-172
 11 mm
 Fig 4

1/4
08-173
 15 mm
 Fig 5

08-126 - 148
DITTEL
 Metall bougies and
 dilating sounds, stiff
 345 mm

08-149 - 161
BAKES
 Common bile duct
 dilators, malleable
 08-149-153 315 mm
 08-154-161 320 mm

08-162 - 165
DESJARDINS
 Probe and catch
 with flexible shaft
 300 mm

08-166 - 173
LUER-KOERTE modif
 with malleable shaft
 310 mm

Gall Stone Forceps

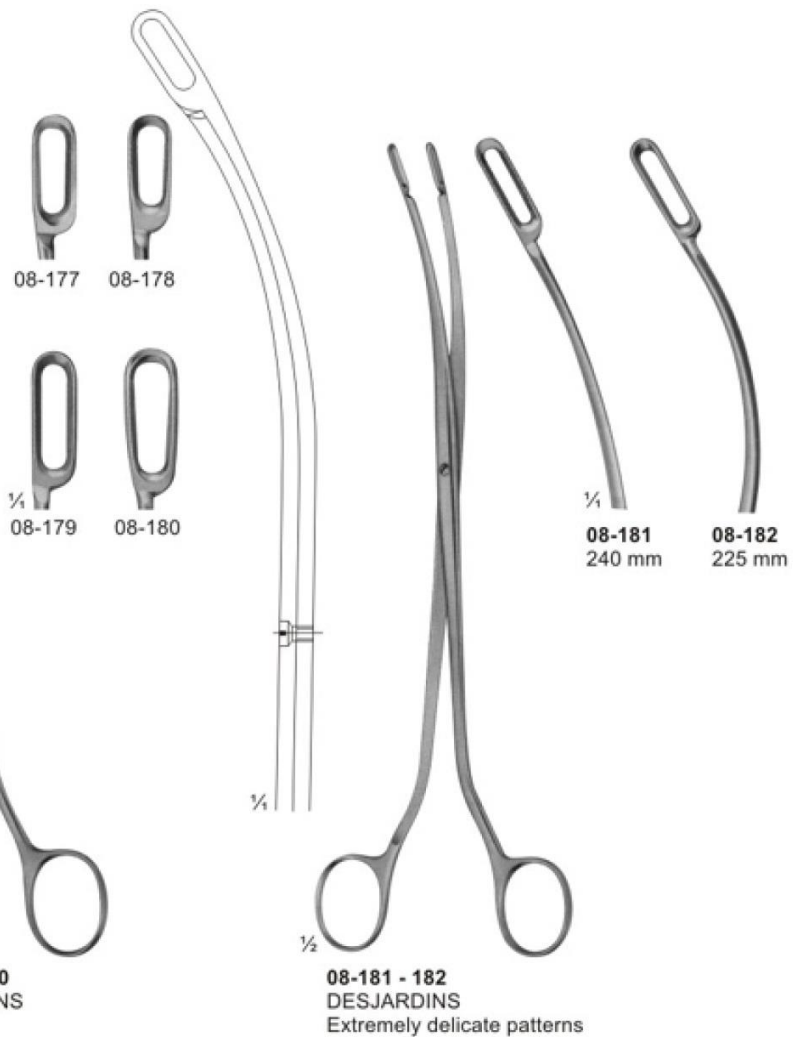
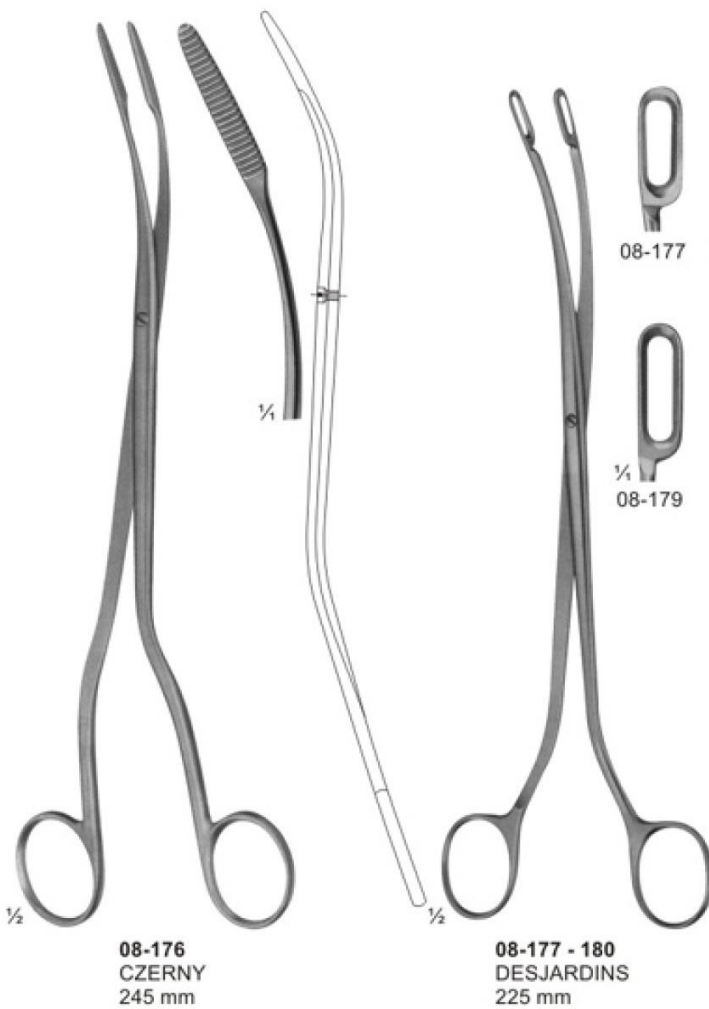
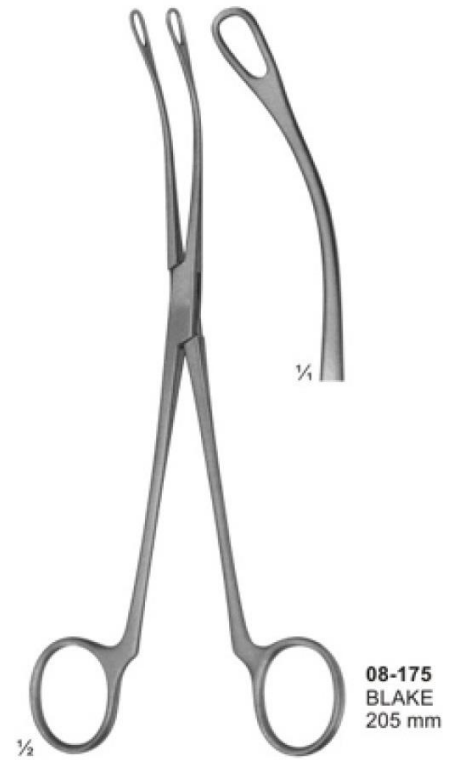

Kidney Clamps

ATRAUMATA

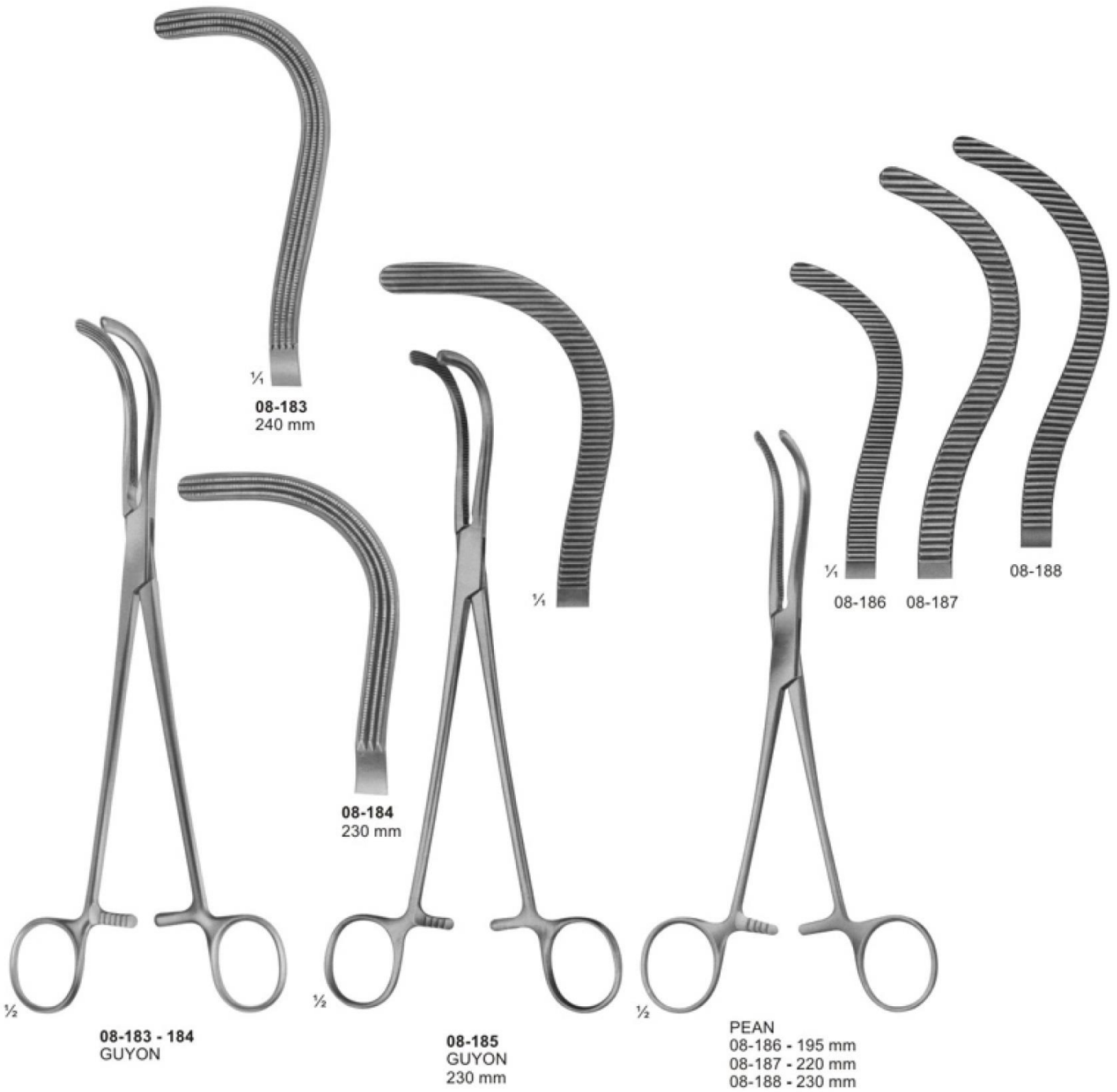

Kidney Stone Forceps



08-189



08-190



08-191



$\frac{1}{4}$
08-192

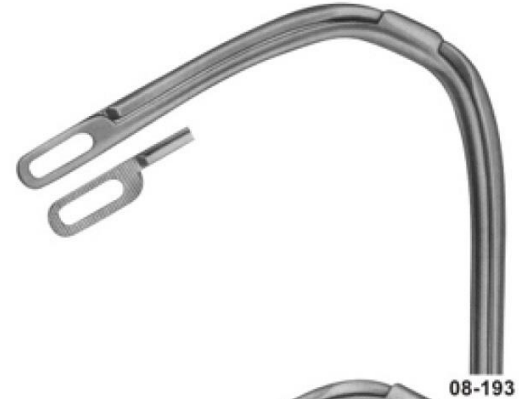

08-193



08-194



$\frac{1}{4}$
08-195



$\frac{1}{2}$

08-189 - 192
RANDALL
225 mm



$\frac{1}{2}$

08-193 - 195
RANDALL
190 mm

Bladder Retractors

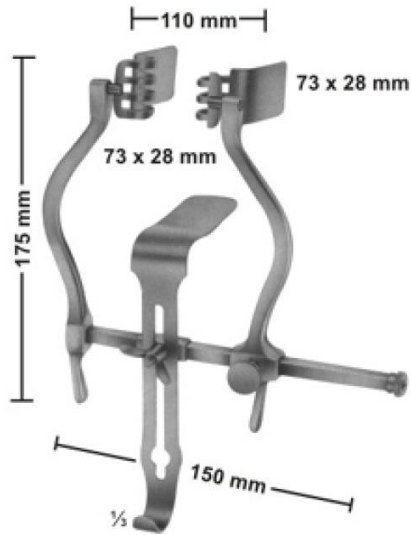

09-101
JUDD-MASSON
 Bladder-and suprapubic retractor

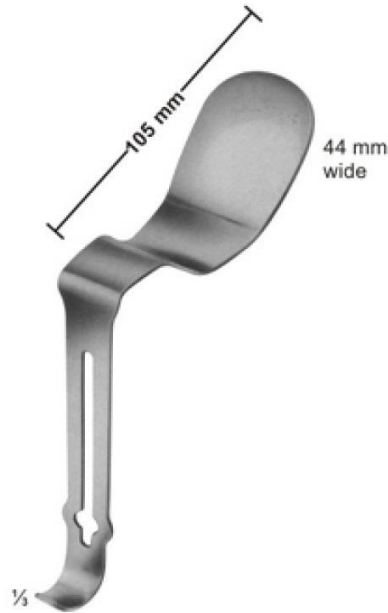

09-102
MILLIN
 Center bladder for retro pubic prostatectomy



09-103
MILLIN
 Bladder retractor, complete 105X45 mm

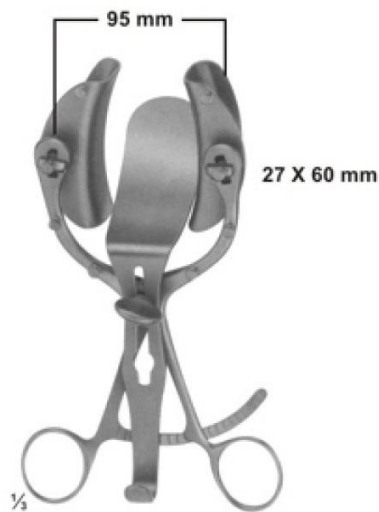

09-104
LEGUEU
 Bladder retractor
 Center blade
 80 x 31 mm

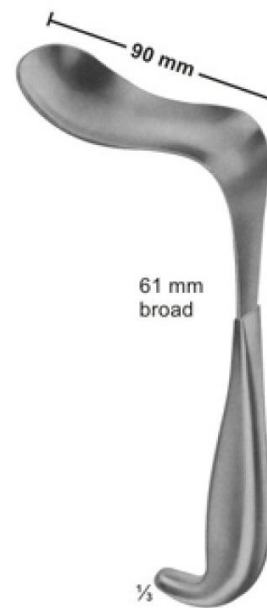

09-105
KOCHER
 Bladder spatula
 235 mm

Trocars

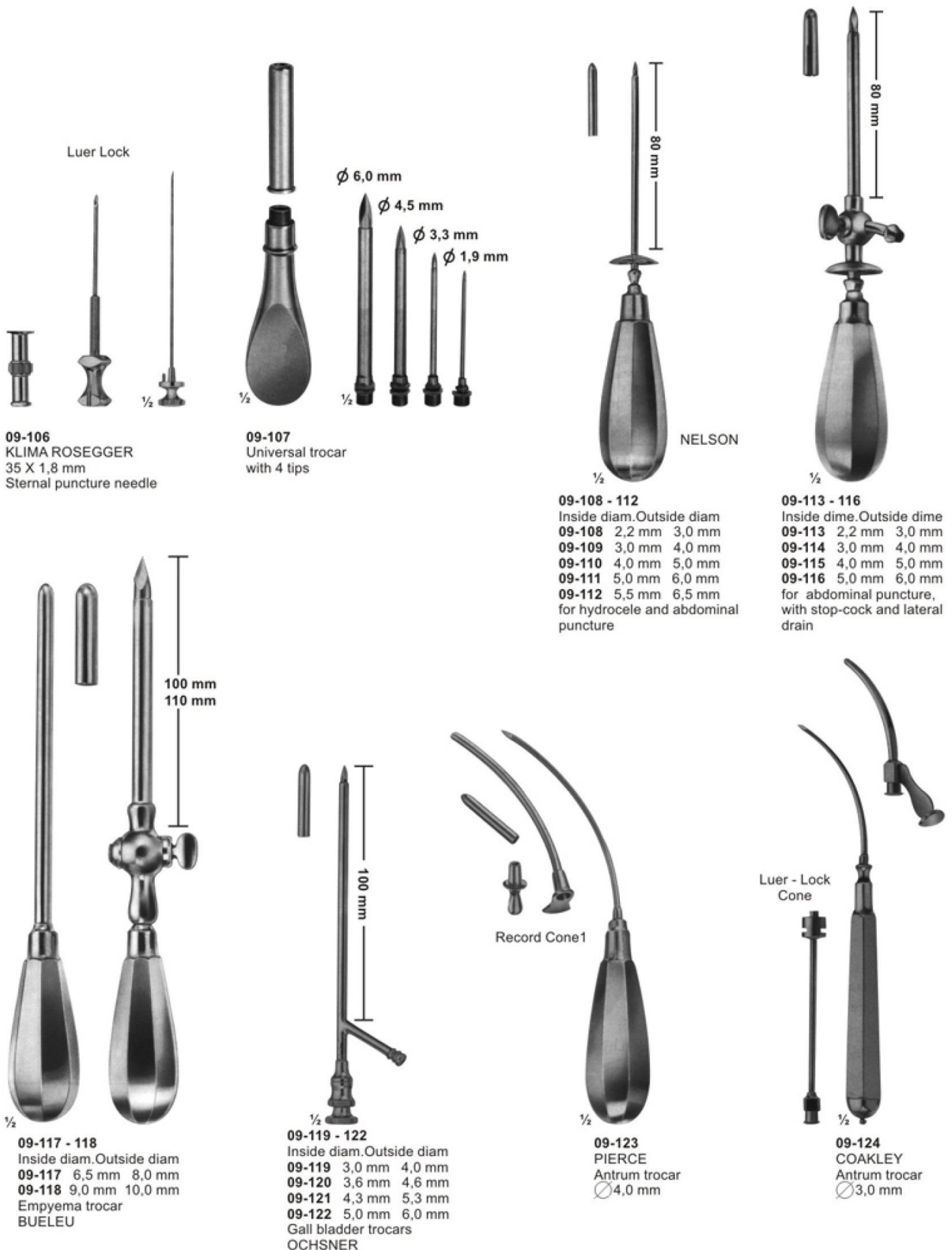

Luer Lock

09-106 KLIMA ROSEGGER
 35 X 1,8 mm
 Sternal puncture needle

09-107 Universal trocar
 with 4 tips

ϕ 6,0 mm
 ϕ 4,5 mm
 ϕ 3,3 mm
 ϕ 1,9 mm

NELSON

09-108 - 112
 Inside diam. Outside diam
09-108 2,2 mm 3,0 mm
09-109 3,0 mm 4,0 mm
09-110 4,0 mm 5,0 mm
09-111 5,0 mm 6,0 mm
09-112 5,5 mm 6,5 mm
 for hydrocele and abdominal puncture

09-113 - 116
 Inside diam. Outside diam
09-113 2,2 mm 3,0 mm
09-114 3,0 mm 4,0 mm
09-115 4,0 mm 5,0 mm
09-116 5,0 mm 6,0 mm
 for abdominal puncture,
 with stop-cock and lateral drain

09-117 - 118
 Inside diam. Outside diam
09-117 6,5 mm 8,0 mm
09-118 9,0 mm 10,0 mm
 Empyema trocar
 BUELEU

09-119 - 122
 Inside diam. Outside diam
09-119 3,0 mm 4,0 mm
09-120 3,6 mm 4,6 mm
09-121 4,3 mm 5,3 mm
09-122 5,0 mm 6,0 mm
 Gall bladder trocars
 OCHSNER

Record Cone1

09-123 PIERCE
 Antrum trocar
 ϕ 4,0 mm

09-124 COAKLEY
 Antrum trocar
 ϕ 3,0 mm

Luer - Lock Cone

Vaginal Specula

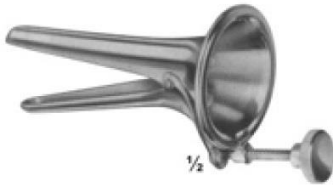

10-101
COLLIN
 for children
 53 x 10 mm

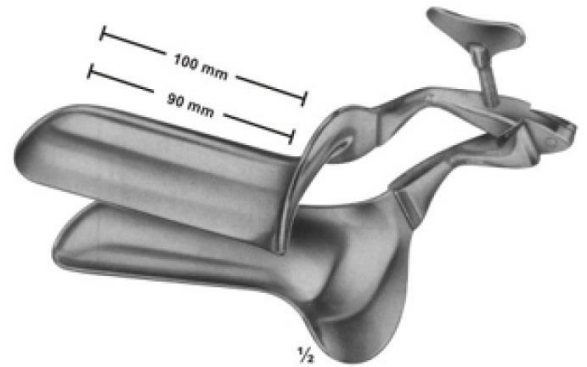

10-102 - 105
COLLIN

10-102	100/90mm	28 mm
10-103	100/90mm	32 mm
10-104	105/95mm	35 mm
10-105	115/105mm	40 mm
Total length/working length		width



10-106
COLLIN
 for virgins
 95/85 x 18 mm



10-107
CUSCO
 for virgins
 75 x 17 mm



10-108
CUSCO
 for virgins
 75 x 17 mm

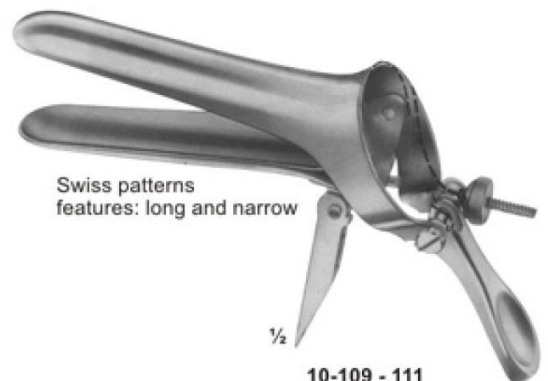

Swiss patterns
 features: long and narrow

10-109 - 111
CUSCO

10-109	92X23-25 mm
10-110	100x25-27 mm
10-111	110x27-30 mm

Vaginal Specula- Sets, upper and lower blades

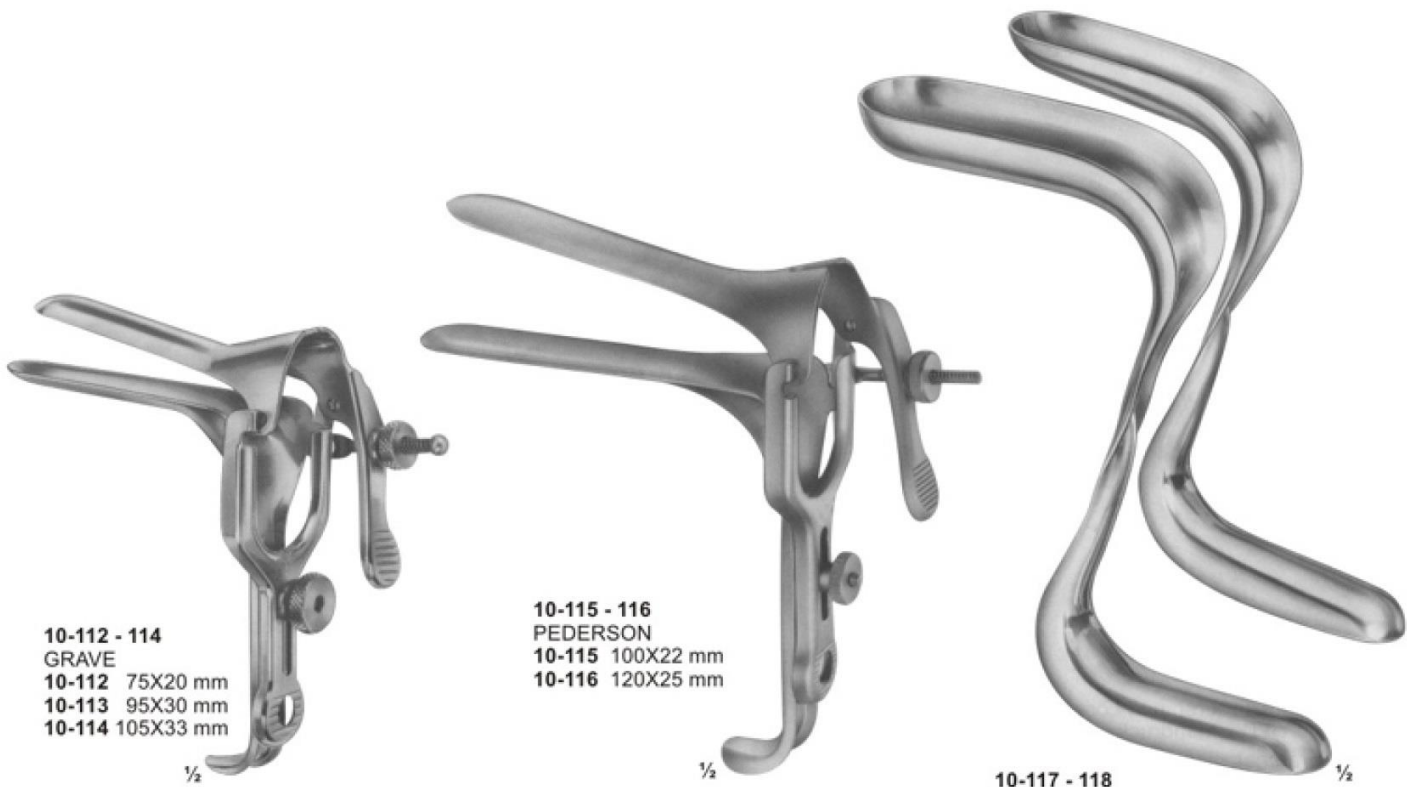

10-112 - 114
GRAVE
 10-112 75X20 mm
 10-113 95X30 mm
 10-114 105X33 mm

10-115 - 116
PEDERSON
 10-115 100X22 mm
 10-116 120X25 mm

10-117 - 118
BRIESKY
 10-117 72X25 mm / 77X30 mm 140 mm
 10-118 75X30 mm / 92X38 mm 170 mm

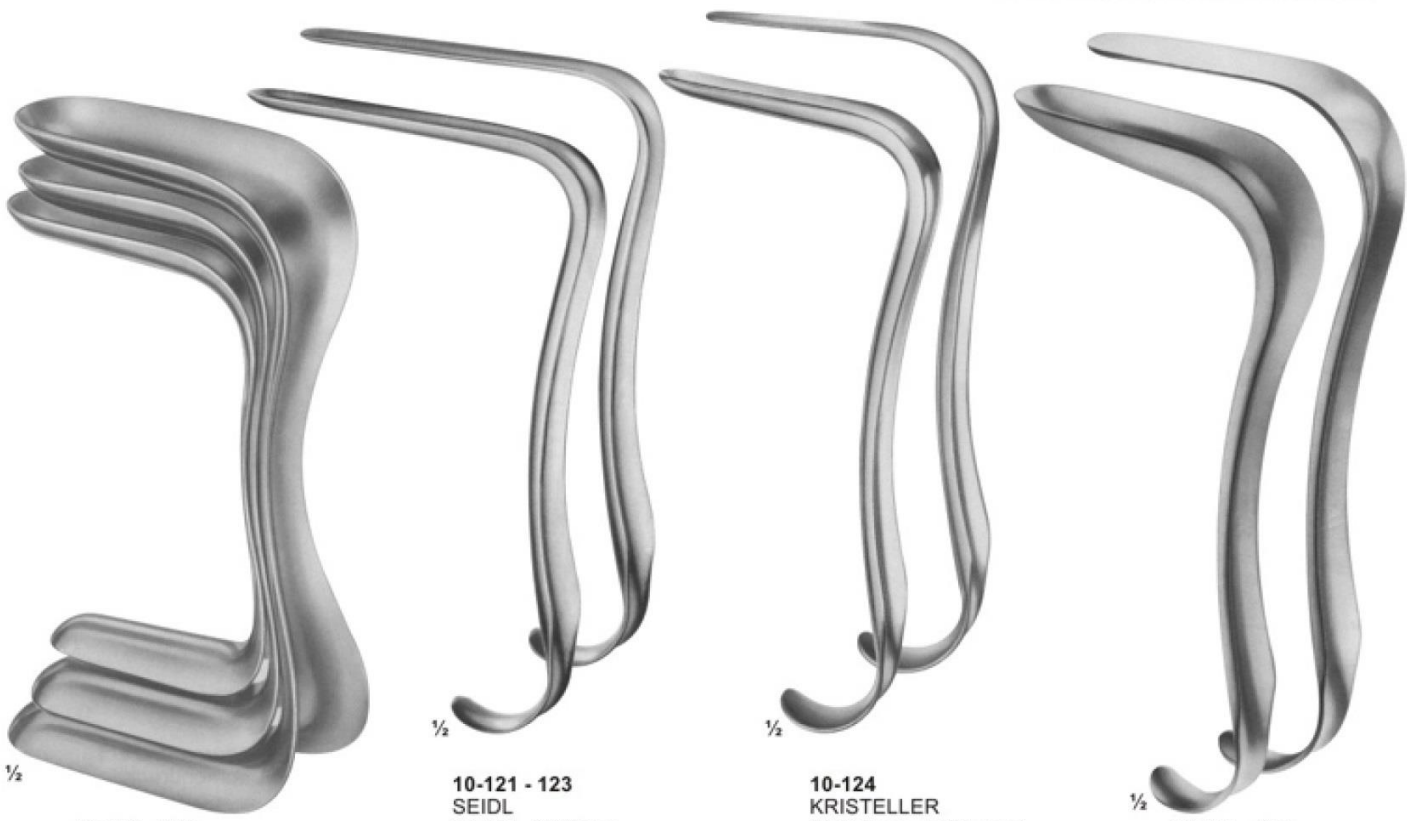

10-119 - 120
SIMS
 70 X 26 mm / 75 X 30 mm
 75 X 30 mm / 80 X 35 mm
 80 X 36 mm / 90 X 40 mm
 175 mm

10-121 - 123
SEIDL
 10-121 80X8 mm
 10-122 80X10 mm
 10-123 90X14 mm
 For children and infants
 170 mm

10-124
KRISTELLER
 70X15 mm, (170 mm)
 For children

10-125 - 127
KRISTELLER
 10-125 70X27 mm
 10-126 75X30 mm
 10-127 90X36 mm
 175 mm

Vaginal Specula- upper and lower blades

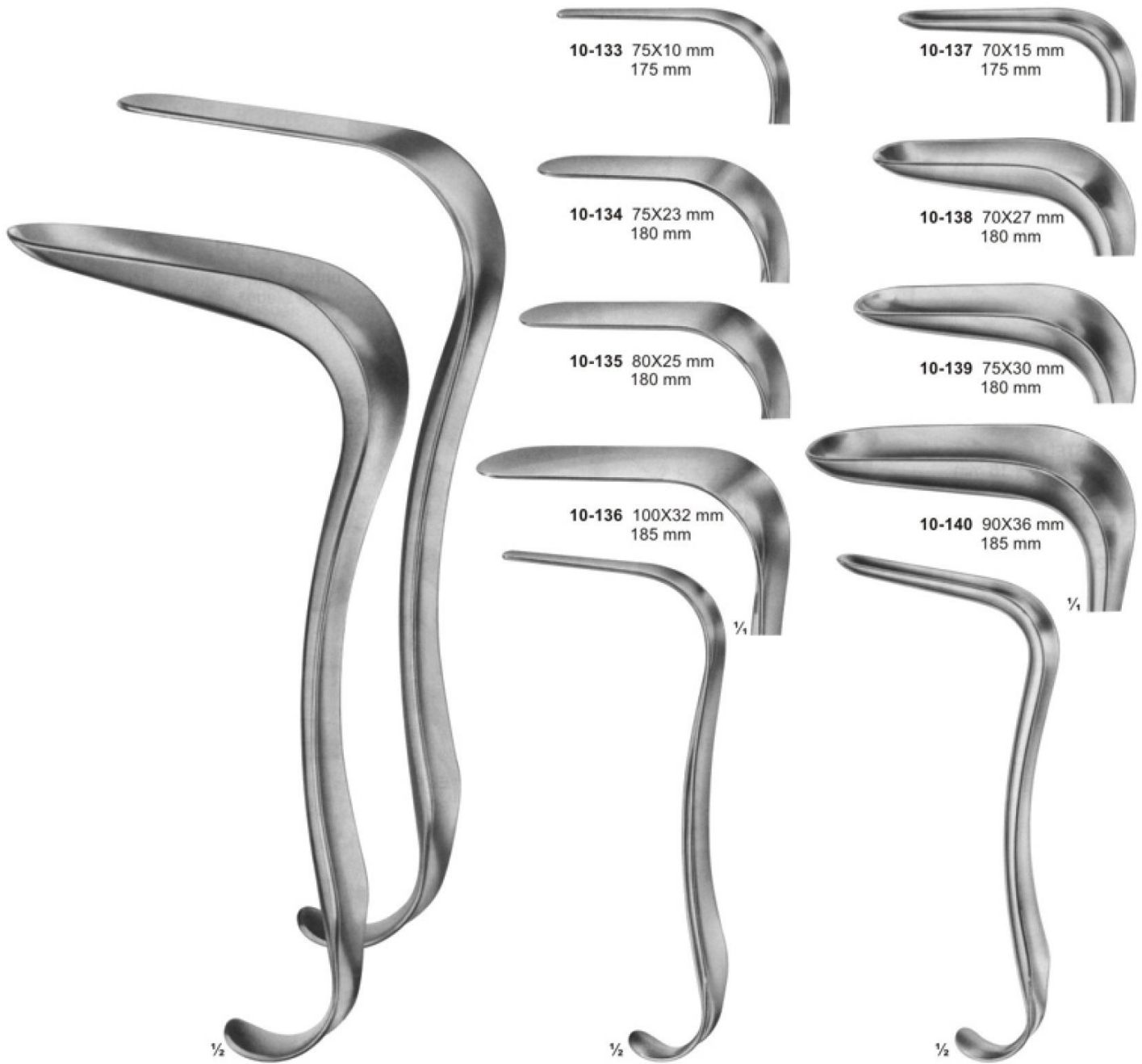

10-128 - 132
KRISTELLER
 10-128 110X18 mm
 10-129 110X20 mm
 10-130 110X27 mm
 10-131 110X30 mm
 10-132 110X36 mm
 220 mm

10-133 - 136
KRISTELLER
 Upper blades

10-137 - 140
KRISTELLER
 Lower blades

Vaginal Specula

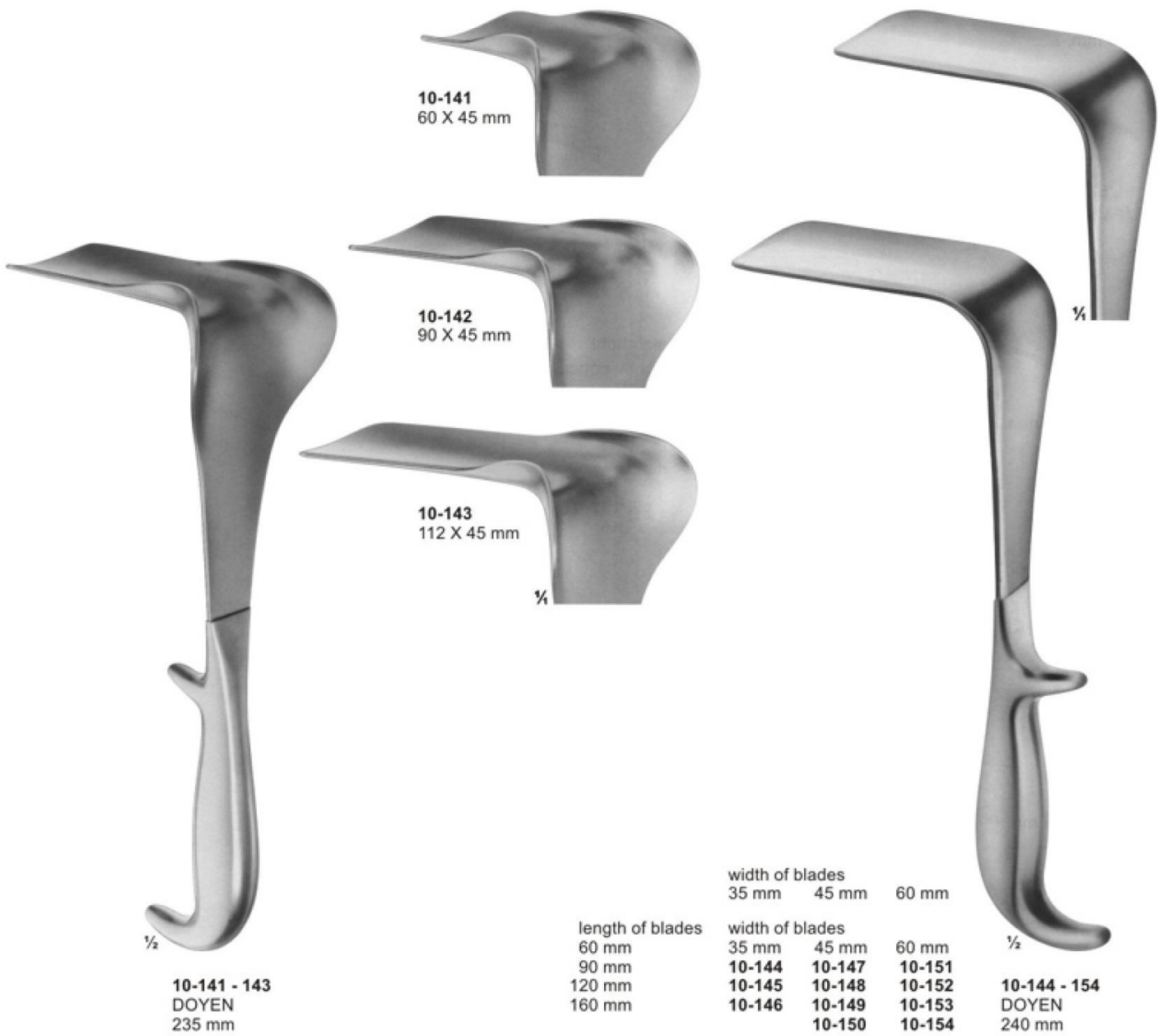

10-141 - 143
 DOYEN
 235 mm

10-141
 60 X 45 mm

10-142
 90 X 45 mm

10-143
 112 X 45 mm

width of blades
 35 mm 45 mm 60 mm

length of blades
 60 mm
 90 mm
 120 mm
 160 mm

width of blades
 35 mm 45 mm 60 mm
10-144 **10-147** **10-151**
10-145 **10-148** **10-152**
10-146 **10-149** **10-153**
 10-150 **10-154**

10-144 - 154
 DOYEN
 240 mm

Vaginal Retractors



10-155
JOLL (FRIEDMAN)
 155 mm



10-156
RICHTER
 170 mm



10-157
GELPI
 135 mm



10-158
GELPI
 175 mm

Uterine Dilators



11-101 - 143
 HEGAR
 with very conical point
 185 mm

11-101	1	mm	11-123	23	mm
11-102	2	mm	11-124	24	mm
11-103	3	mm	11-125	25	mm
11-104	4	mm	11-126	26	mm
11-105	5	mm	11-127	1	½mm
11-106	6	mm	11-128	2	½mm
11-107	7	mm	11-129	3	½mm
11-108	8	mm	11-130	4	½mm
11-109	9	mm	11-131	5	½mm
11-110	10	mm	11-132	6	½mm
11-111	11	mm	11-133	7	½mm
11-112	12	mm	11-134	8	½mm
11-113	13	mm	11-135	9	½mm
11-114	14	mm	11-136	10	½mm
11-115	15	mm	11-137	11	½mm
11-116	16	mm	11-138	12	½mm
11-117	17	mm	11-139	13	½mm
11-118	18	mm	11-140	14	½mm
11-119	19	mm	11-141	15	½mm
11-120	20	mm	11-142	16	½mm
11-121	21	mm	11-143	17	½mm
11-122	22	mm			



11-144 - 152
 HEGAR
 205 mm

11-144	1+2	mm
11-145	3+4	mm
11-146	5+6	mm
11-147	7+8	mm
11-148	9+10	mm
11-149	11+12	mm
11-150	13+14	mm
11-151	15+16	mm
11-152	17+18	mm

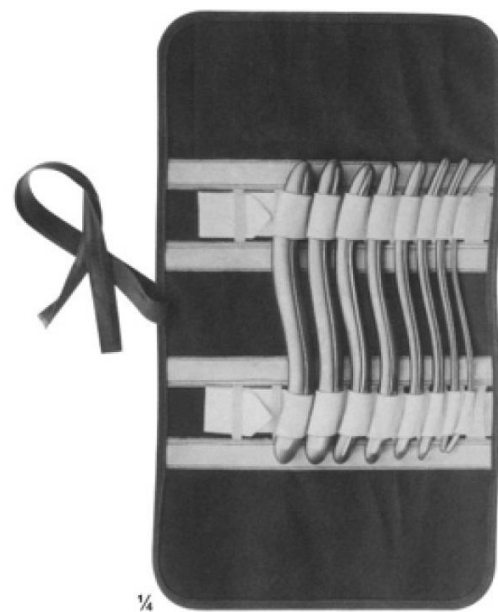

11-153
 HEGAR
 Uterine dilator set, in canvas
 roll with 8 dilators.

Uterine Probes

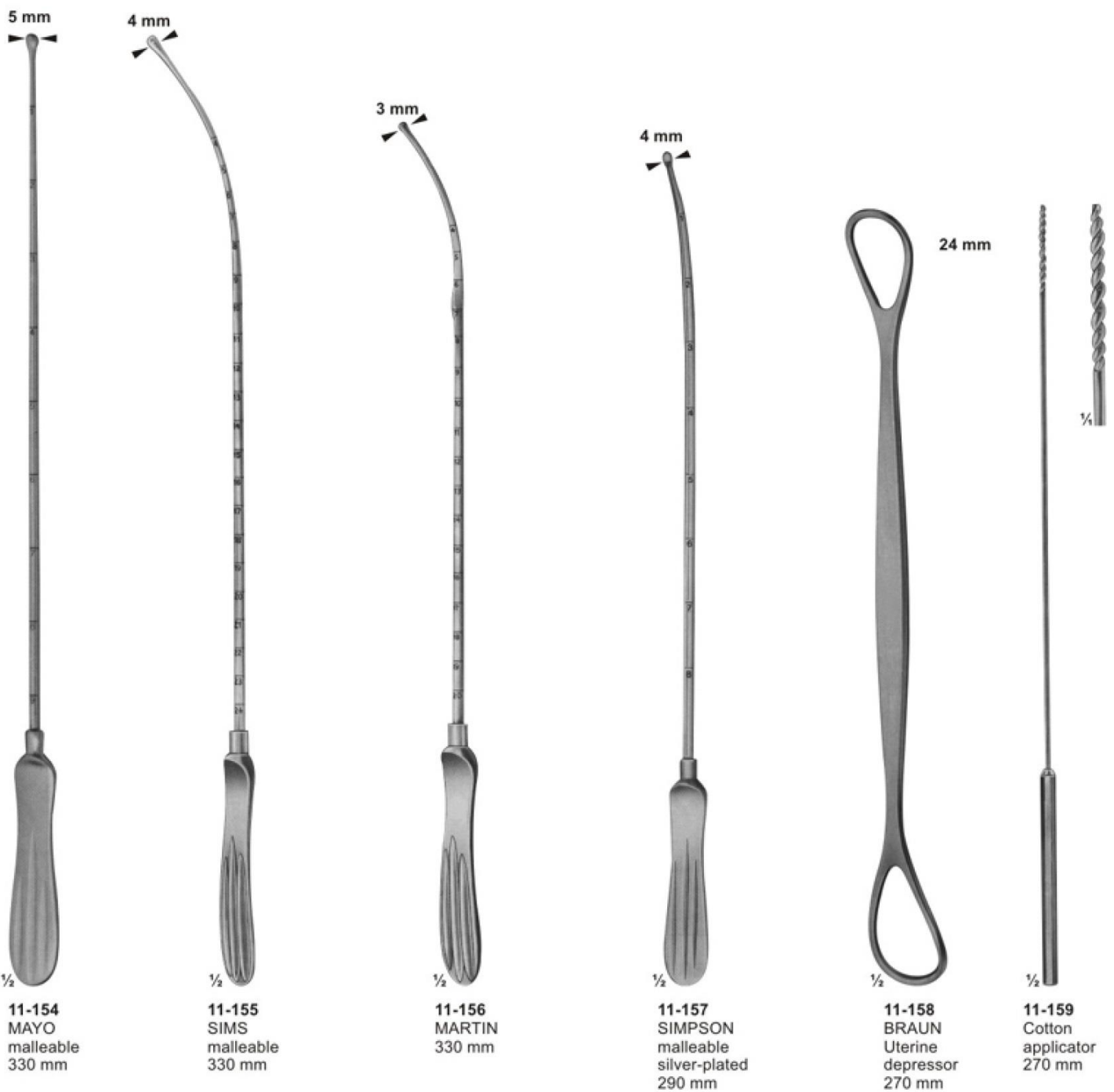

Uterine Dressing Forceps



11-160
PELKMANN
260 mm



11-161
PELKMANN
260 mm

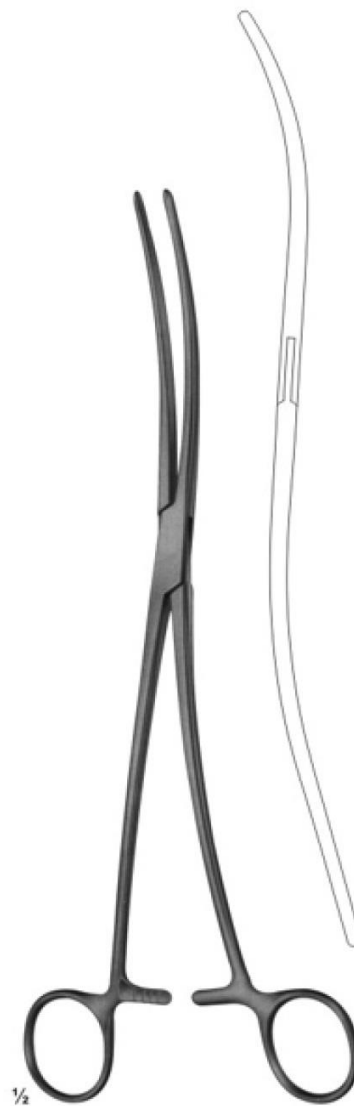

11-162
BOZEMANN
250 mm



11-163
BOZEMANN
255 mm

Jaws with longitudinal groove

Polypus-and Ovum Forceps

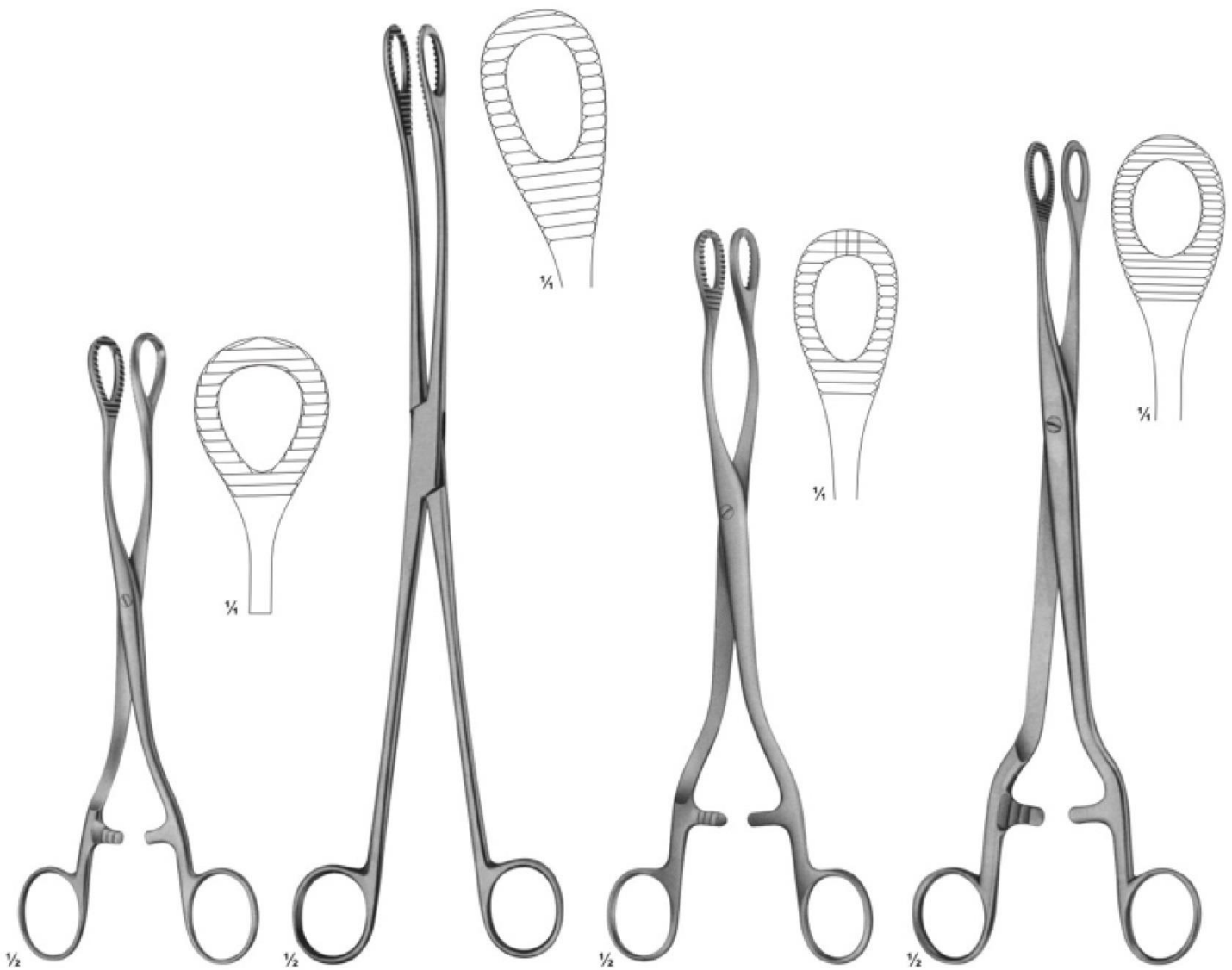

11-164
HEYWOOD-SMITH
200 mm

11-165
KELLY
320 mm

11-166
HEYWOOD-SMITH
250 mm

11-167
NOTO
280 mm

Biopsy Curettes

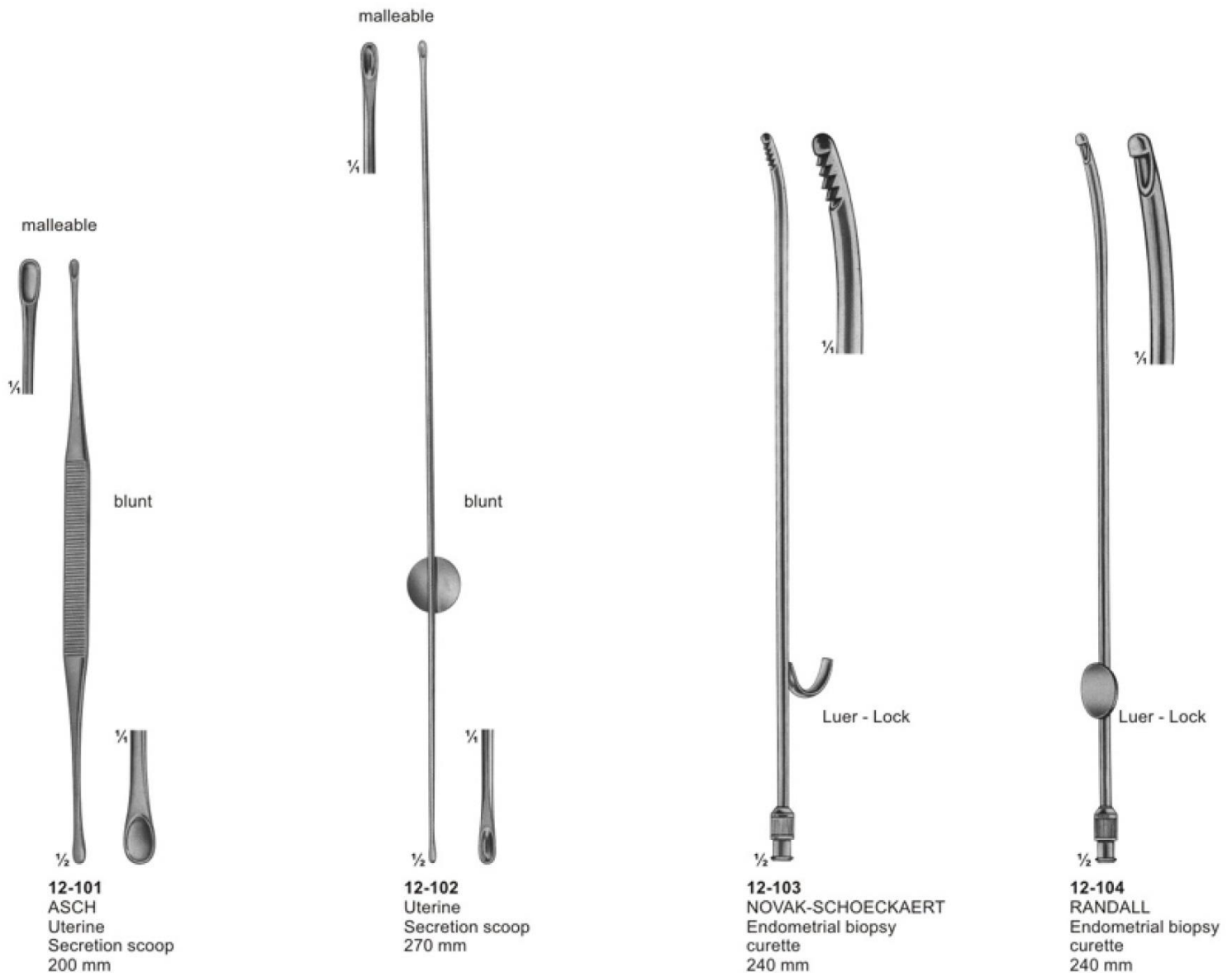

Biopsy Forceps

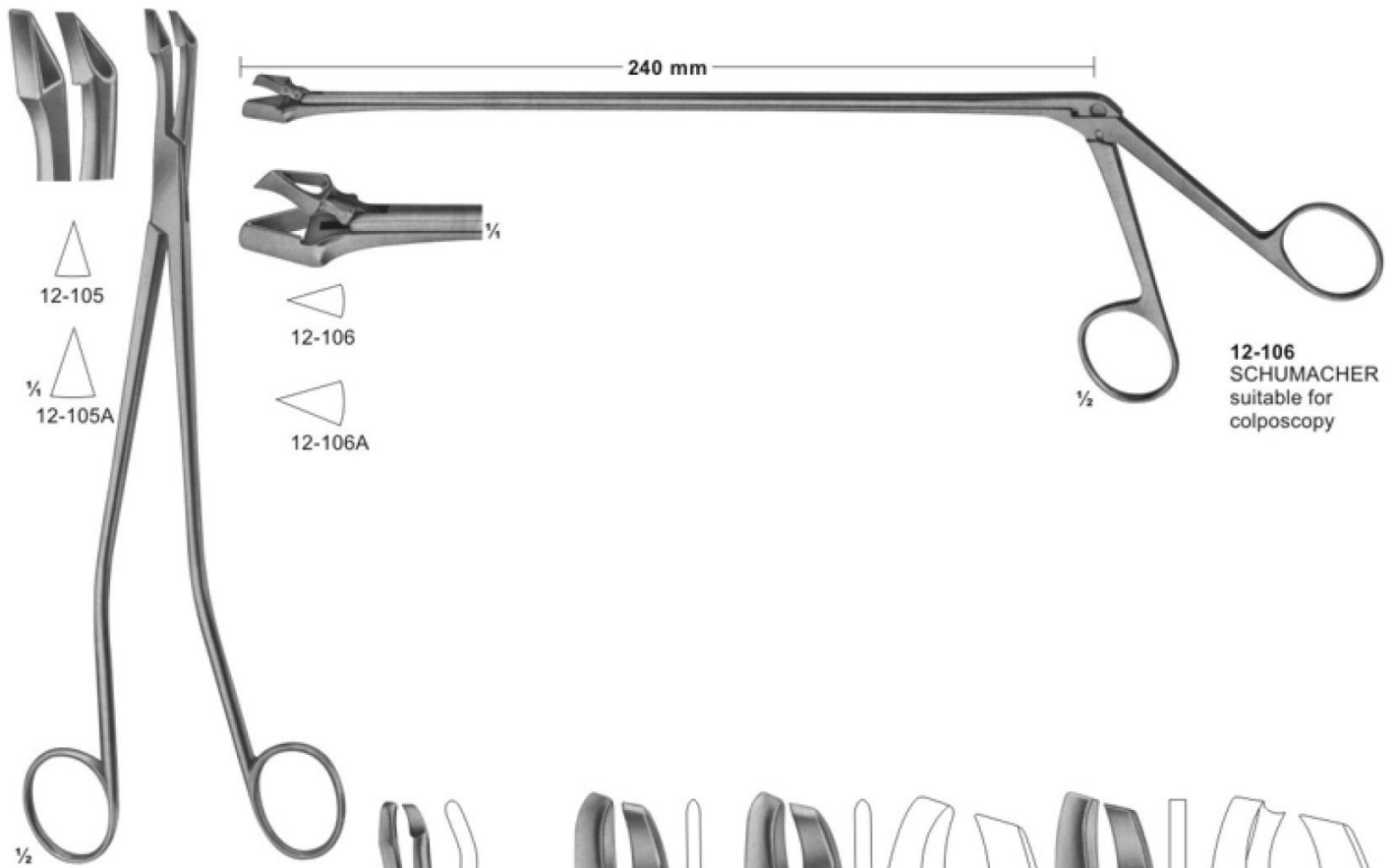

12-105

12-105A

12-106

12-106A

12-106
 SCHUMACHER
 suitable for
 colposcopy

12-105
 SCHUMACHER
 240mm

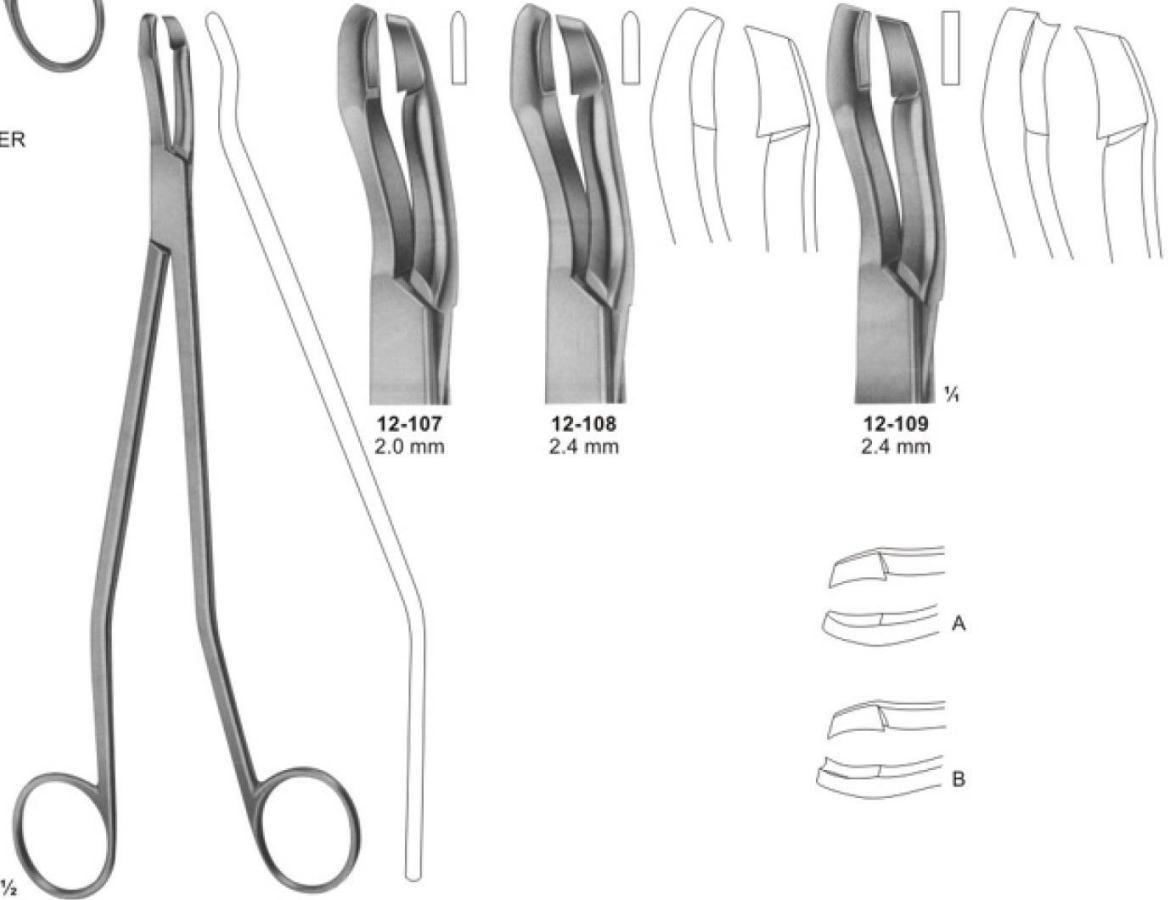

12-107
 2.0 mm

12-108
 2.4 mm

12-109
 2.4 mm

12-107 - 109
 SEIDL DBP
 Biopsy forceps, bayonet shaped
 for portio, vagina and vulva
 240mm

Biopsy Forceps

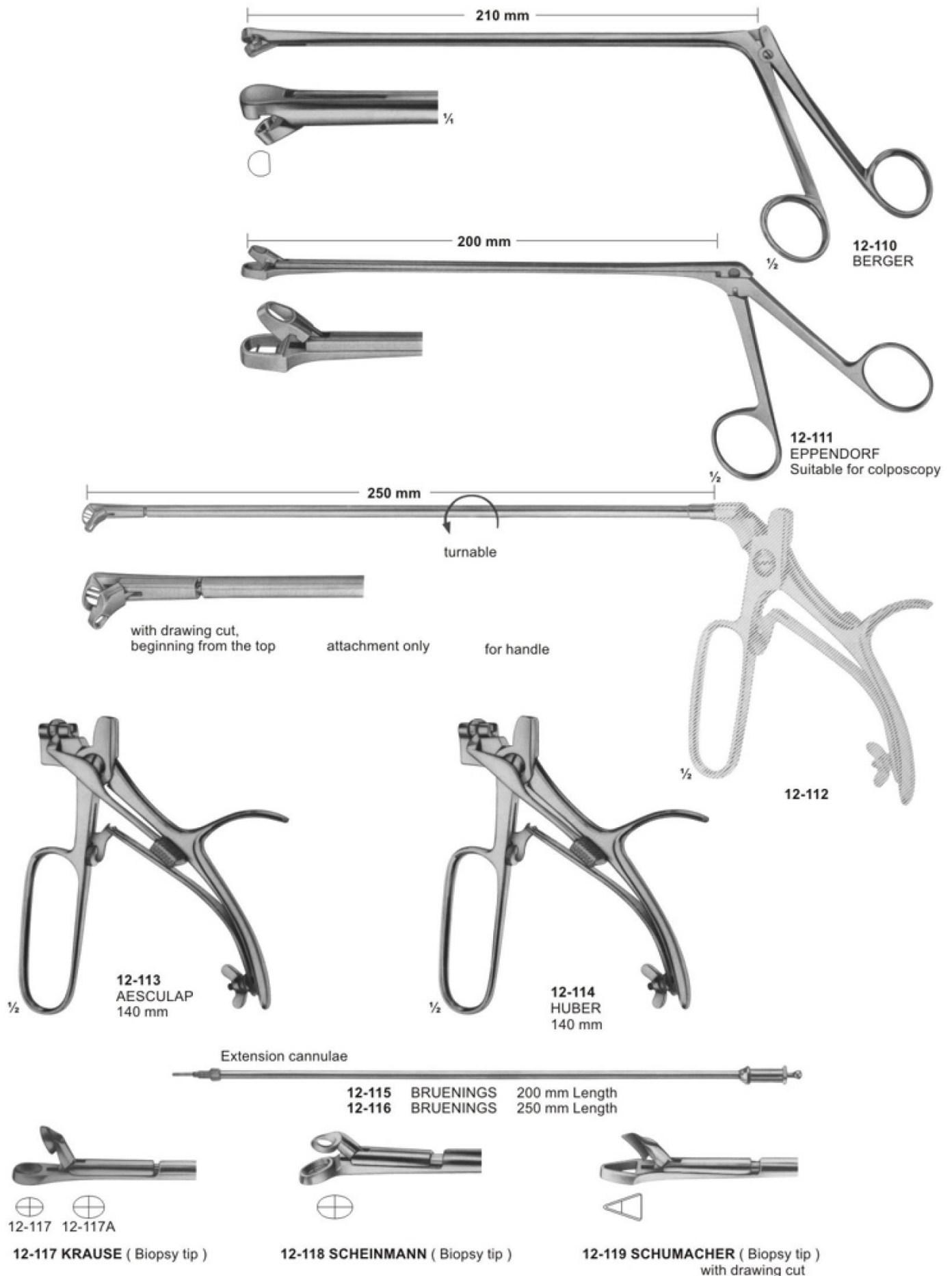

Uterine Scoops

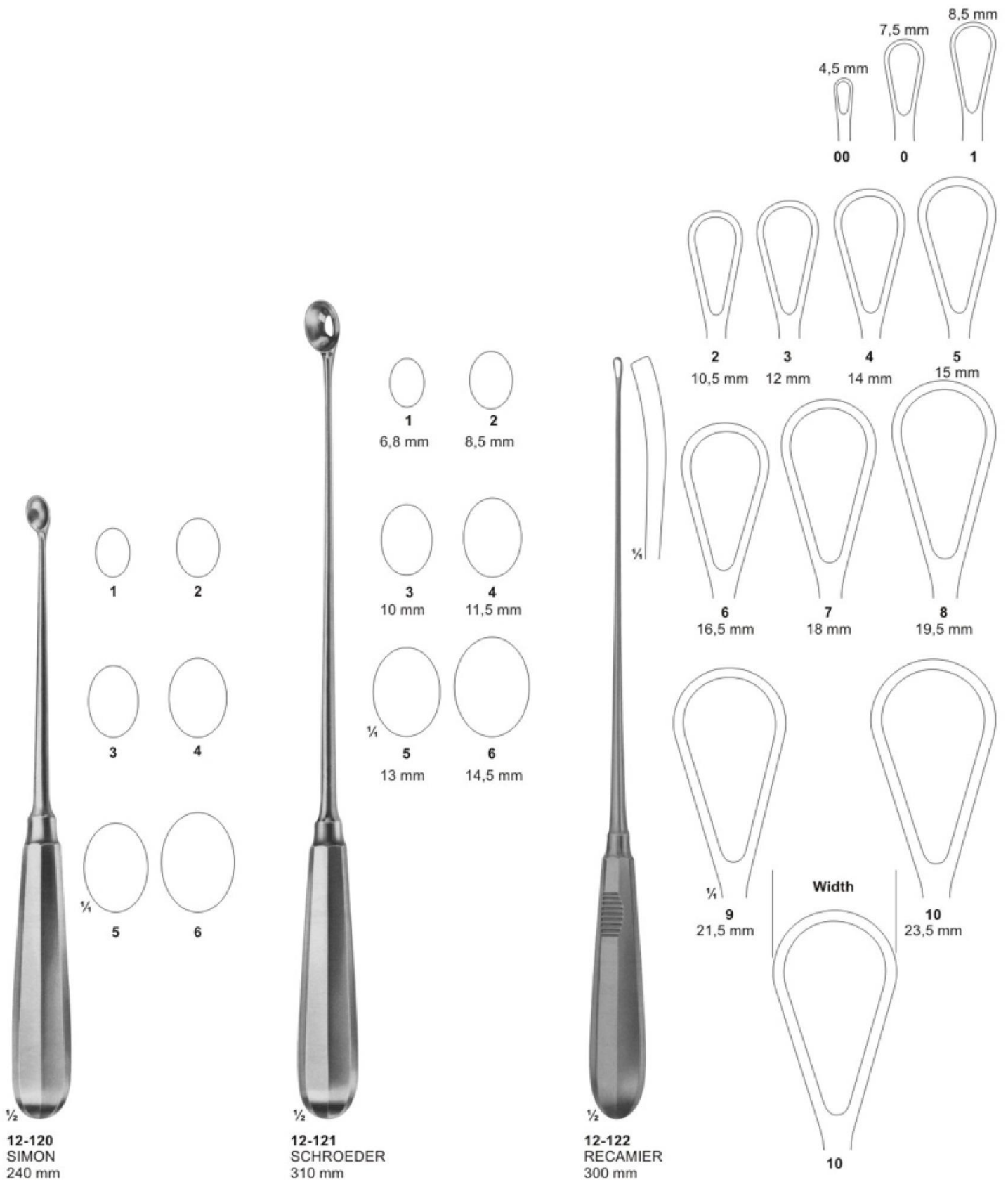

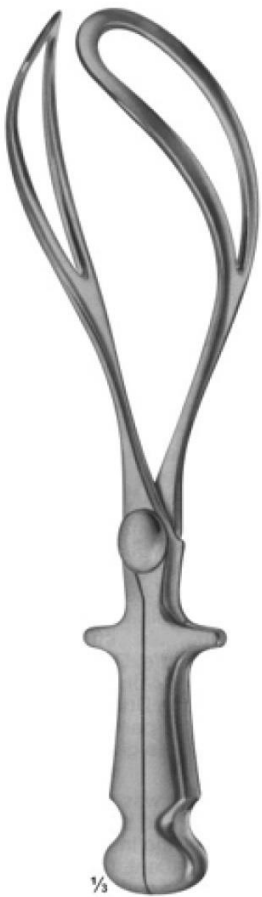

13-101
NAEGELE
355 mm

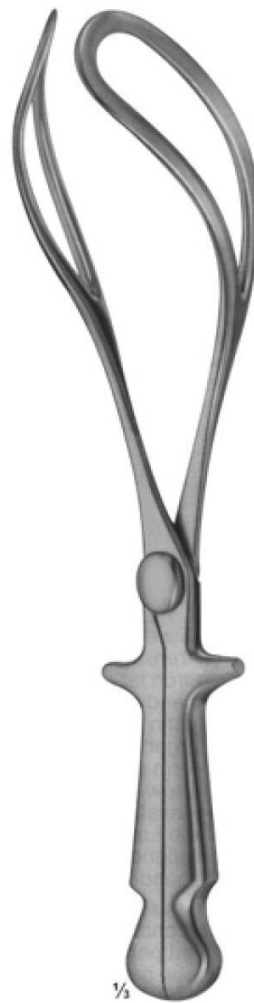

13-102
NAEGELE
400 mm



13-103
SIMPSON-BRAUN
305mm

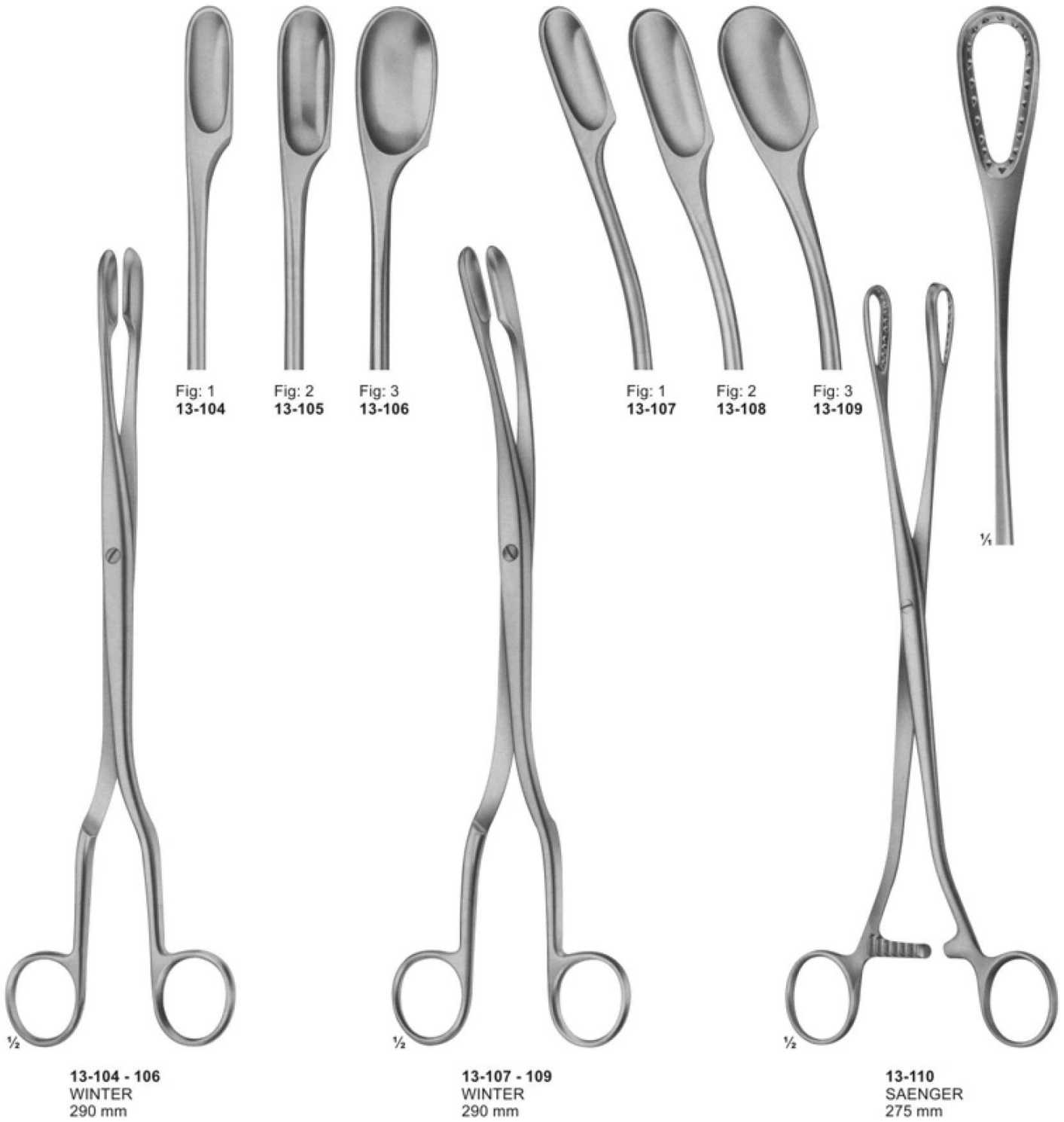

Tound-and Tracheal Hooks and Dilators



13-111
BOSE
 165 mm



13-112
BOSE
 165 mm



13-113 - 115
 180 mm



13-113
 sharp



13-114
 blunt



13-115
 stump/blunt



13-116
FINSEN
 50 mm

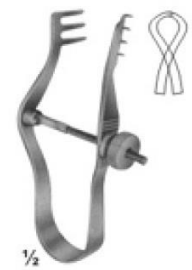

13-117
FINSEN
 70 mm



13-118
TROUSSEAU
 120 mm



13-119
LABORDE
 125 mm

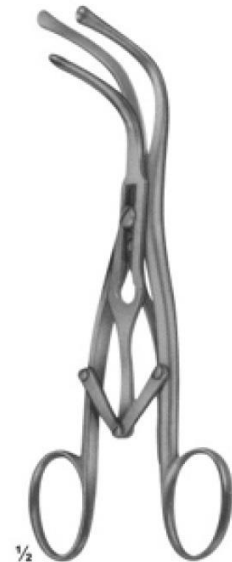

13-120
LABORDE
 strong pattern
 135 mm



13-121
 Cleaning Brush
 for tracheal tubes
 285 mm

Vascular Spatulas

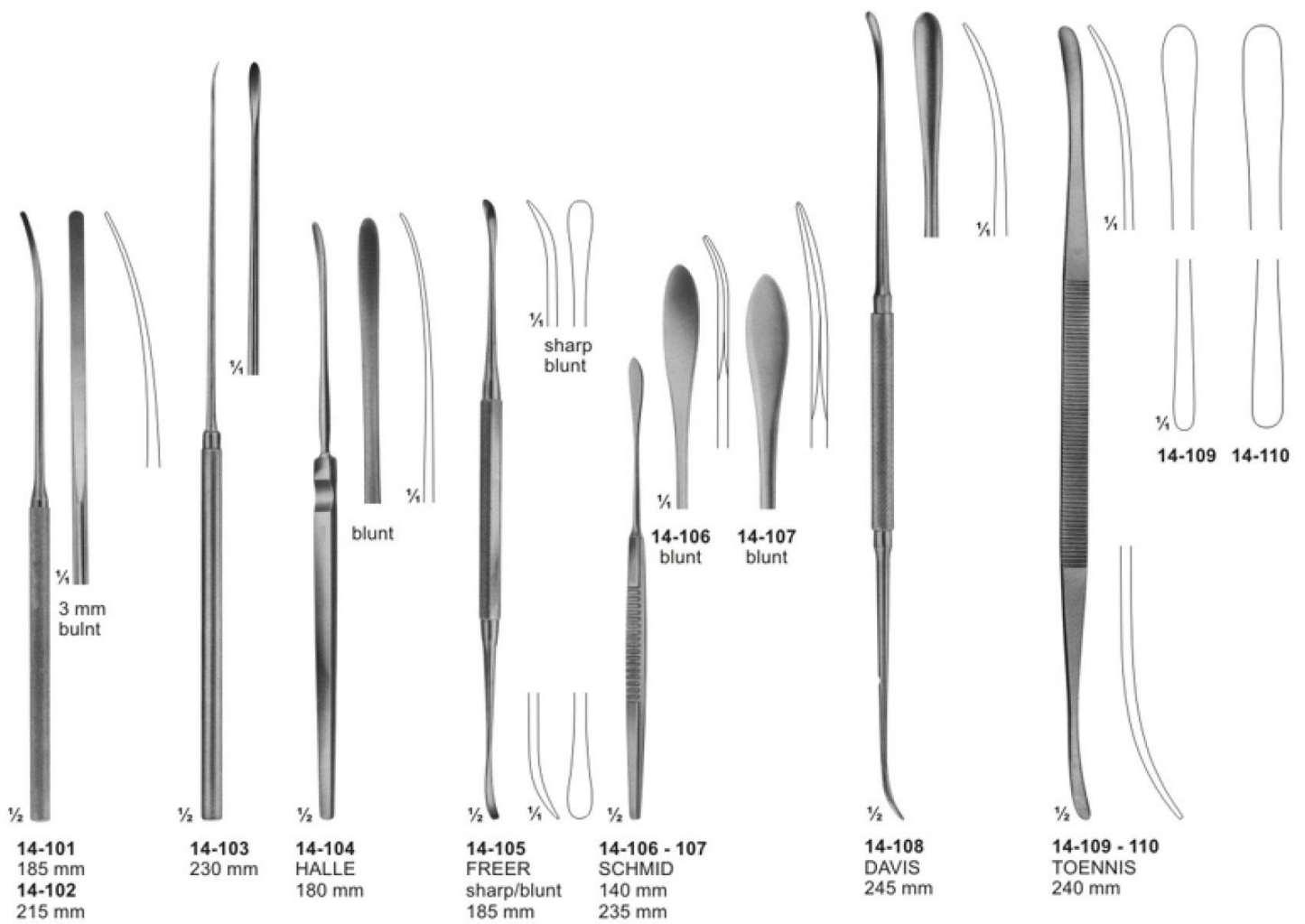

ATRAUMATA Forceps

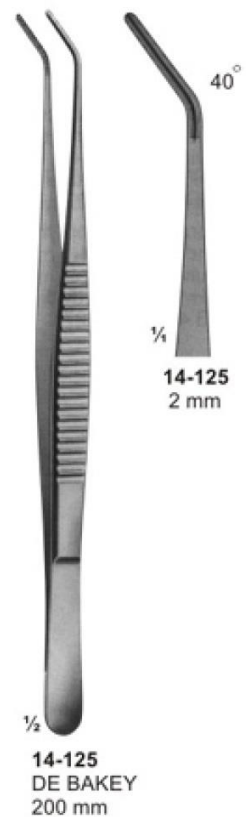
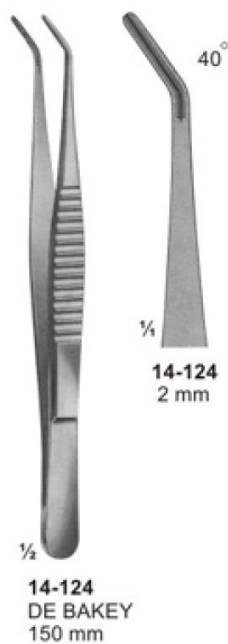
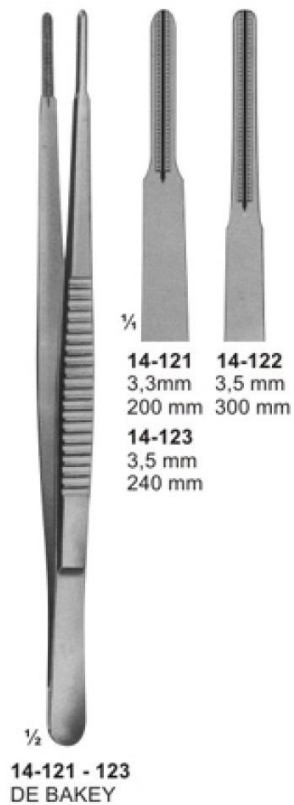
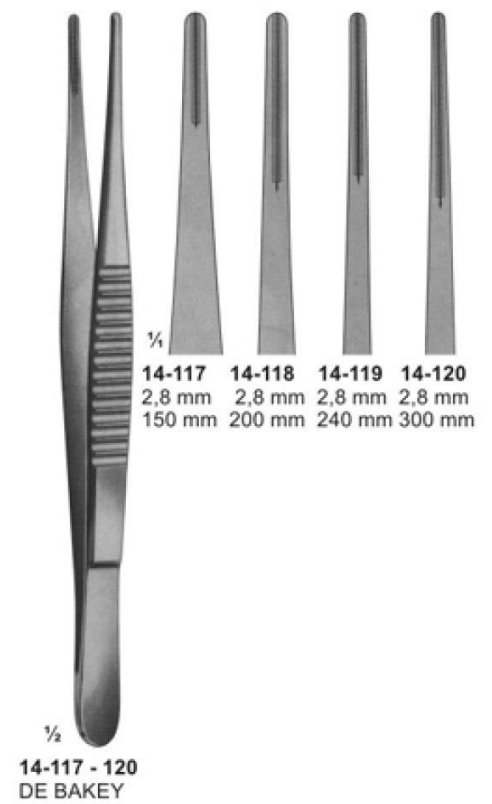
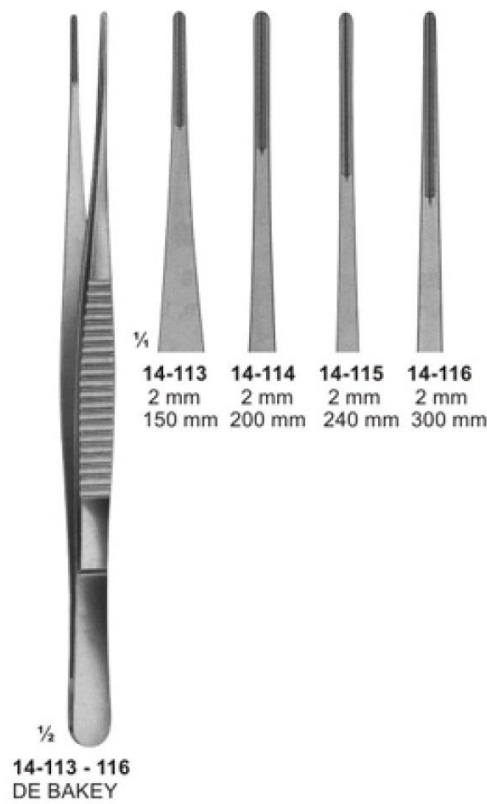
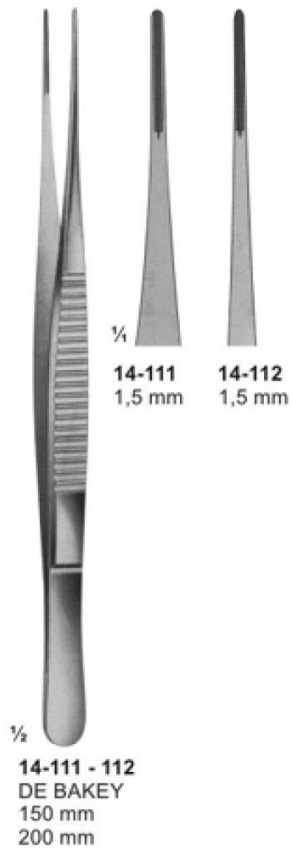

ATRAUMATA
Anastomosis- and Multi- Purpose- Clamps- Pediatric types

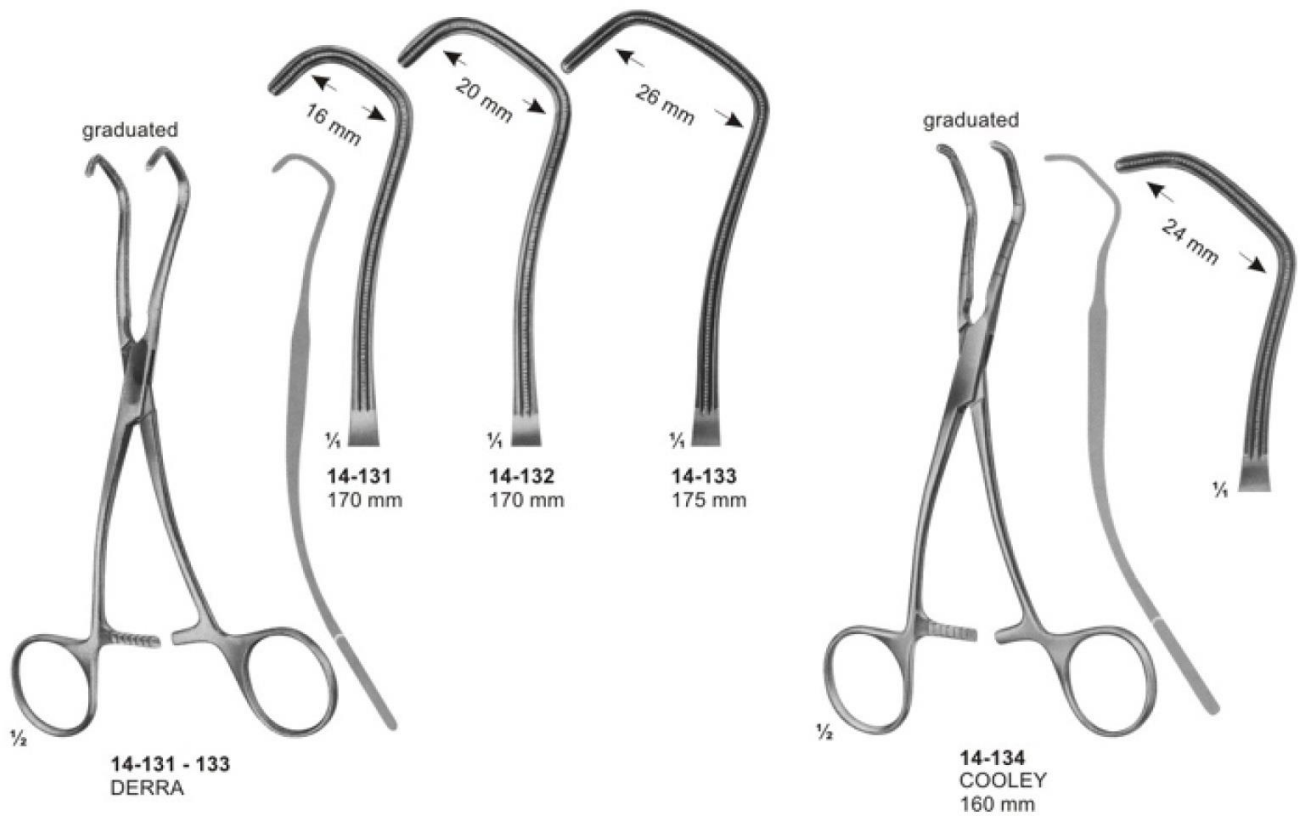
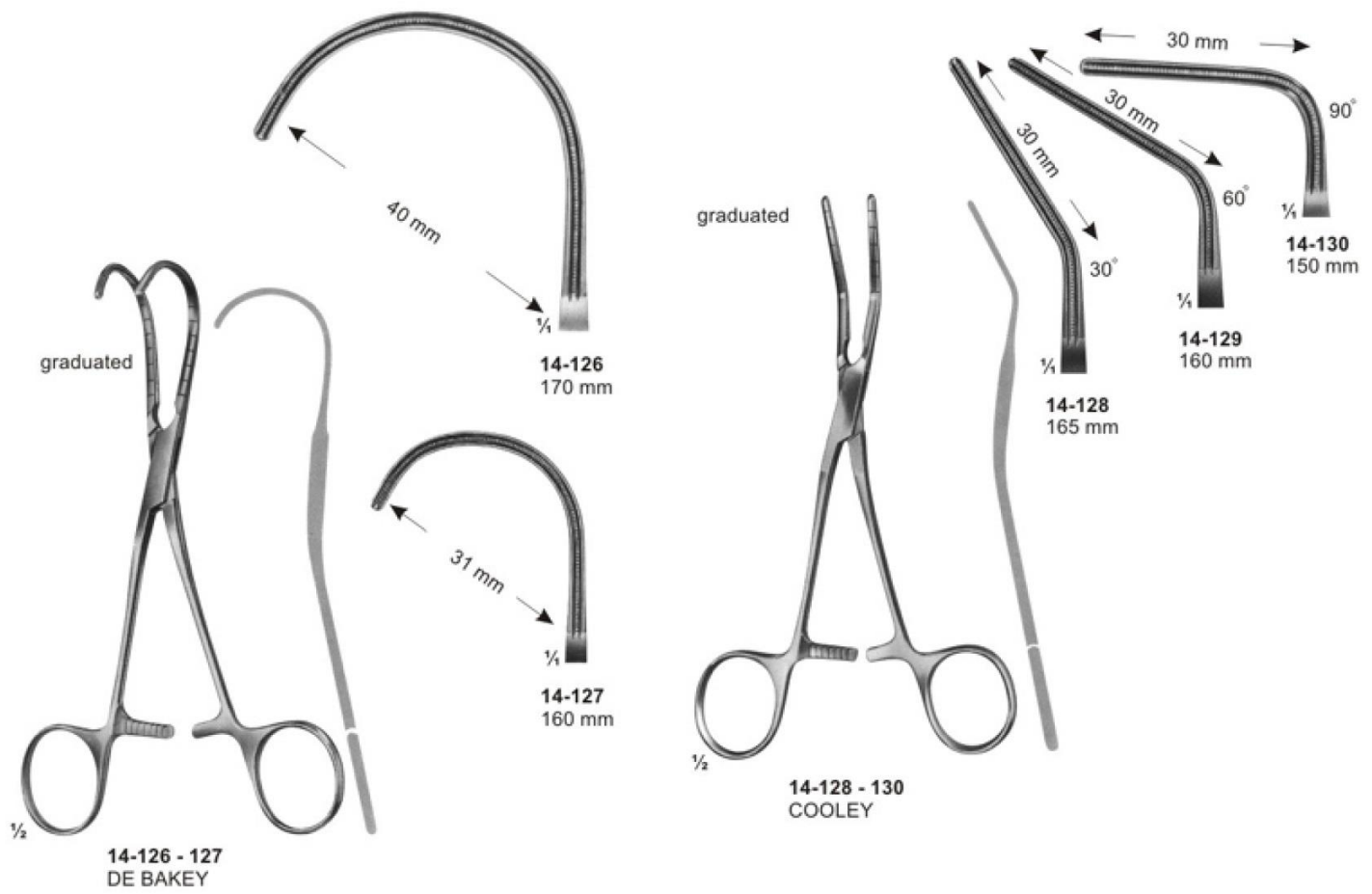

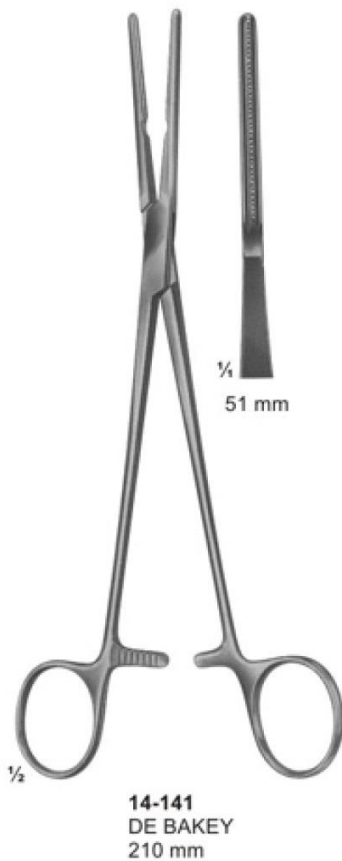
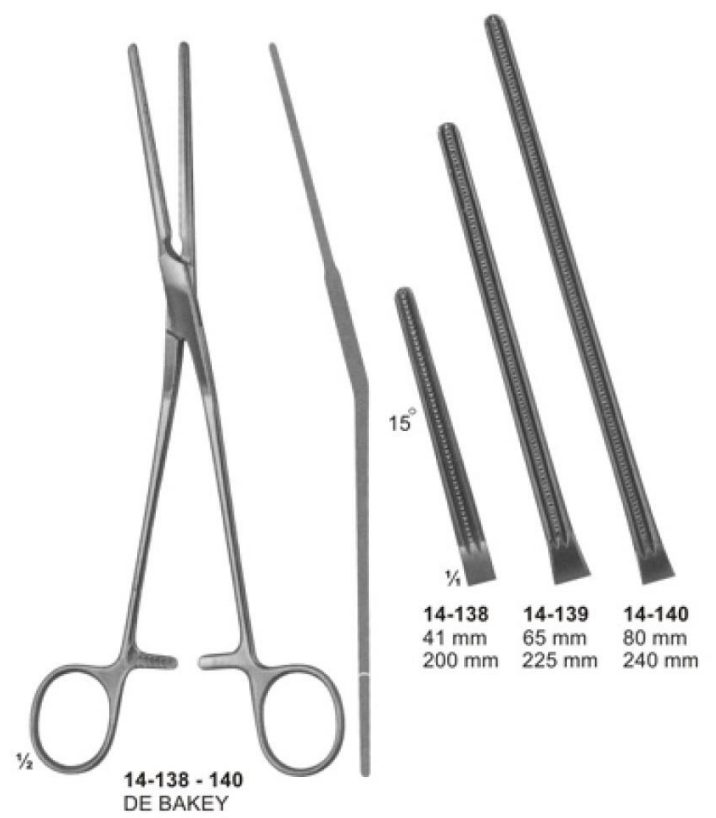

Aorta- Anastomosis Clamps

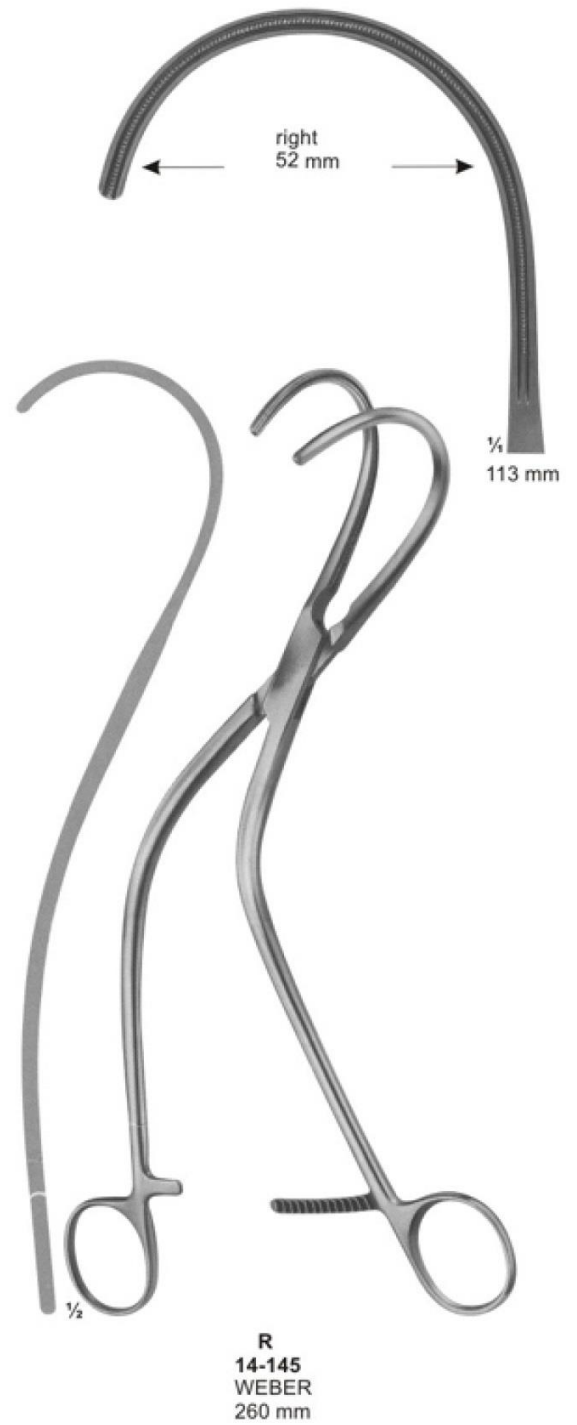
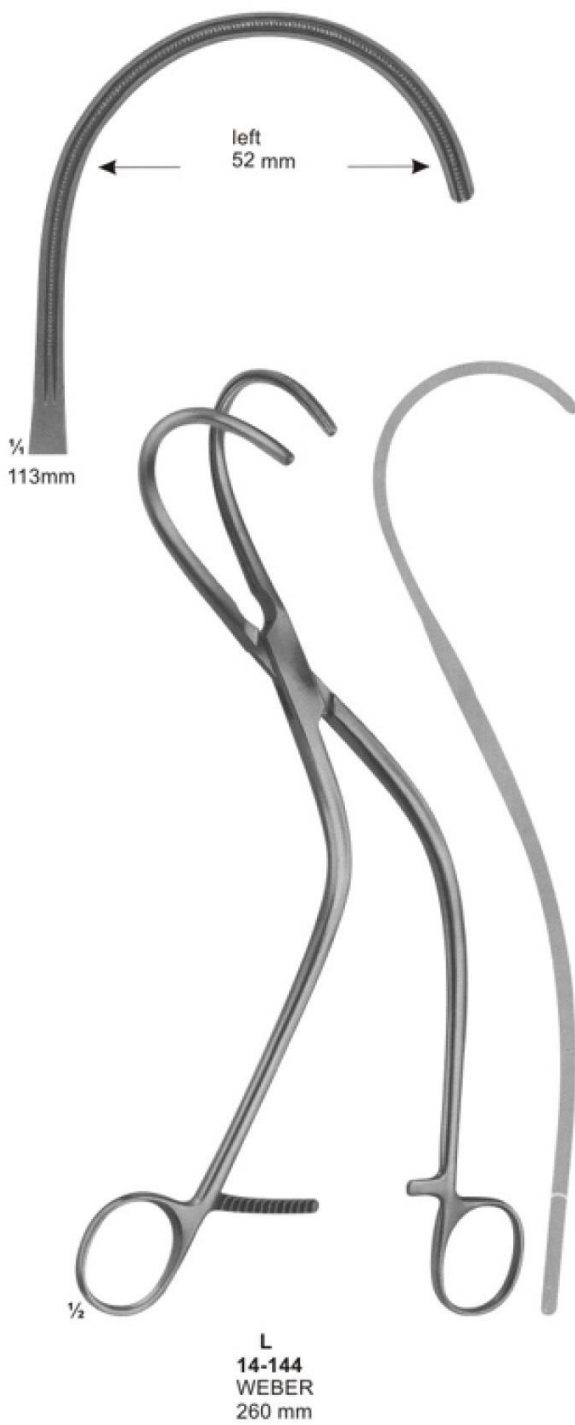

Multi- Purpose-Clamps



1/2 **14-146 - 149**
 DE BAKEY

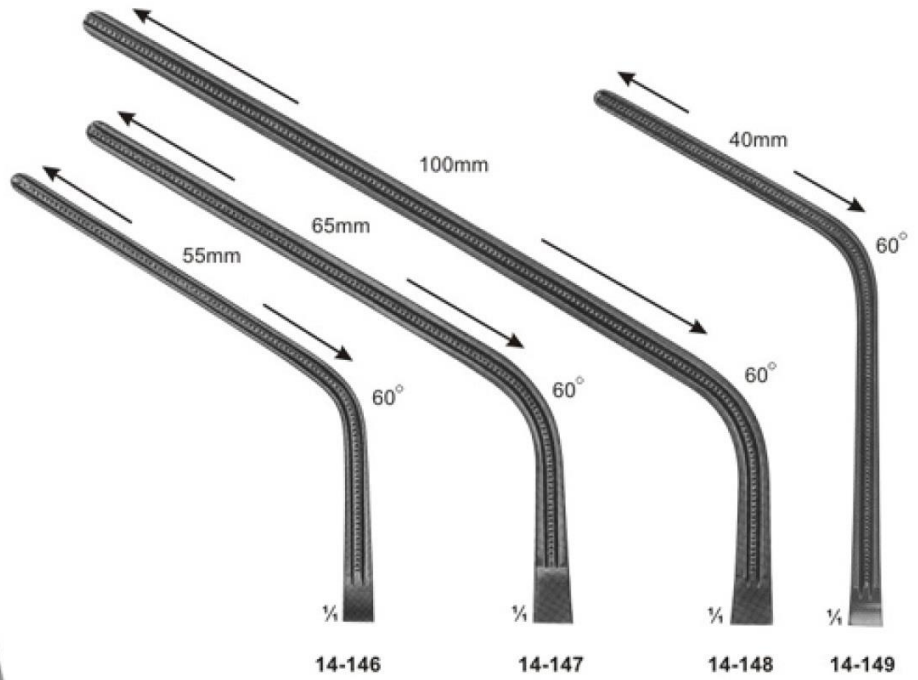

Total Length:	230 mm	280 mm	305 mm	240 mm
Length of jaws:	85 mm	100 mm	135 mm	93 mm



1/2 **14-150 - 153**
 DE BAKEY

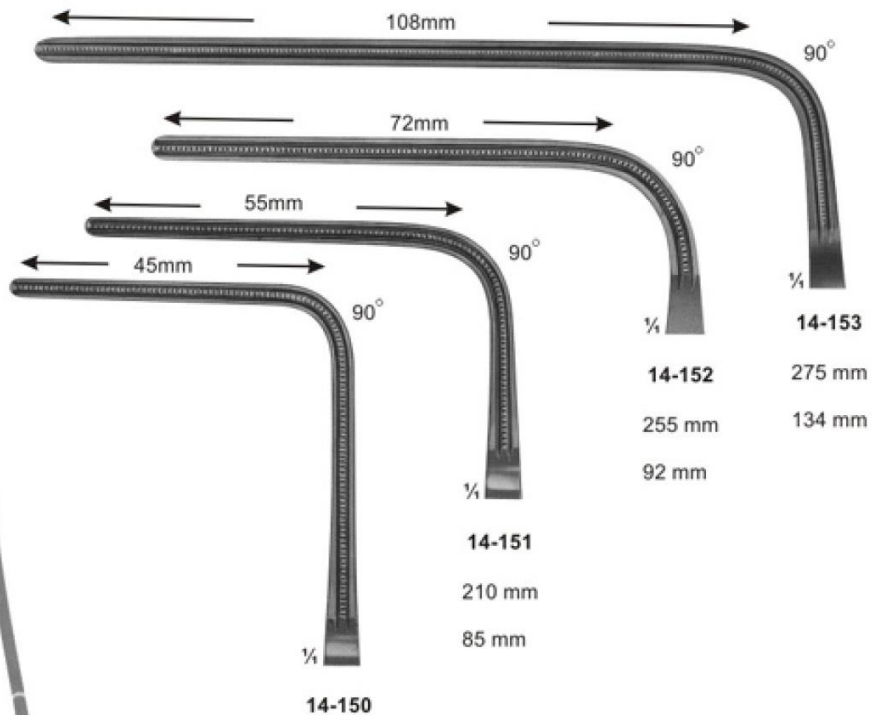

Total Length:	225 mm
Length of jaws:	93 mm

Sternum Instruments and Rib Shears



14-154
SCHUMACHER
 Sternum shears
 210 mm



14-155
LEBSCHE
 Sternum chisel
 200 mm



14-156
 230 mm



14-157
COLLIN
 195 mm



14-158
GLUCK
 190 mm



14-159
BETHUNE
 340 mm



14-160
BRUNNER
 Universal pattern
 340 mm



14-161
GIERTZ-STILLE
 250 mm

Rib Spreaders

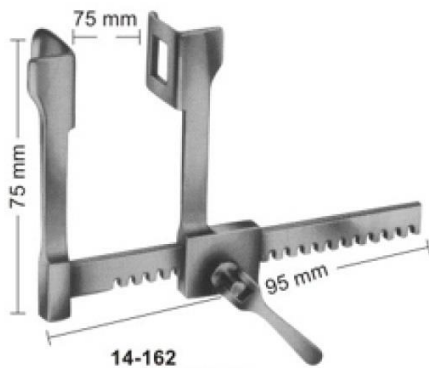

14-162
FINOCHIETTO
 Blades
 18X21 mm

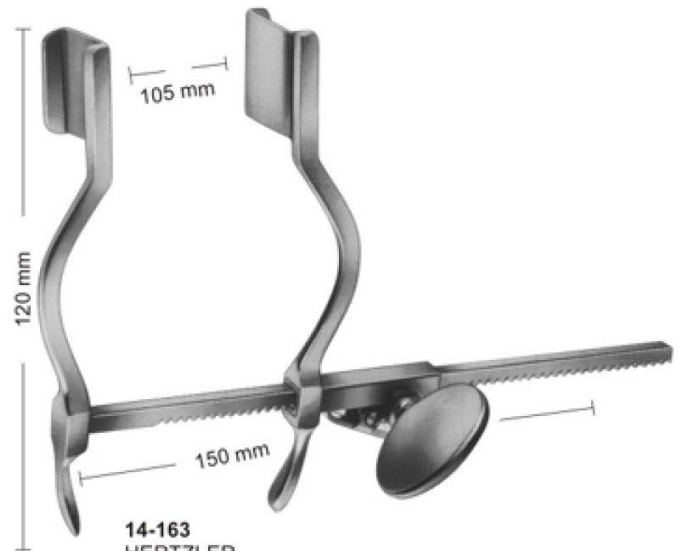

14-163
HERTZLER
 Blades
 20X25 mm

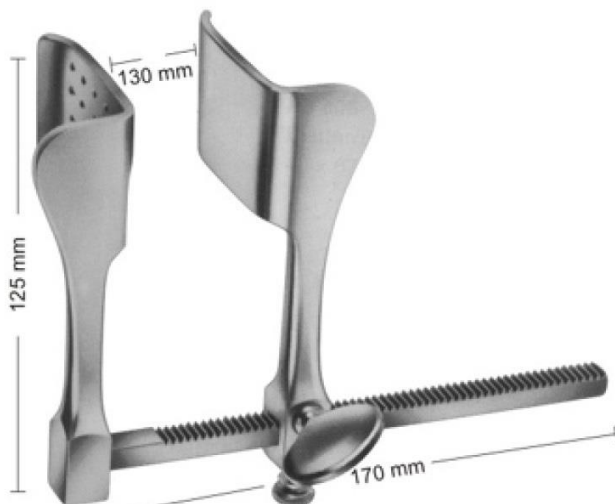

14-164
TUFFIER
 Blades
 43X53 mm

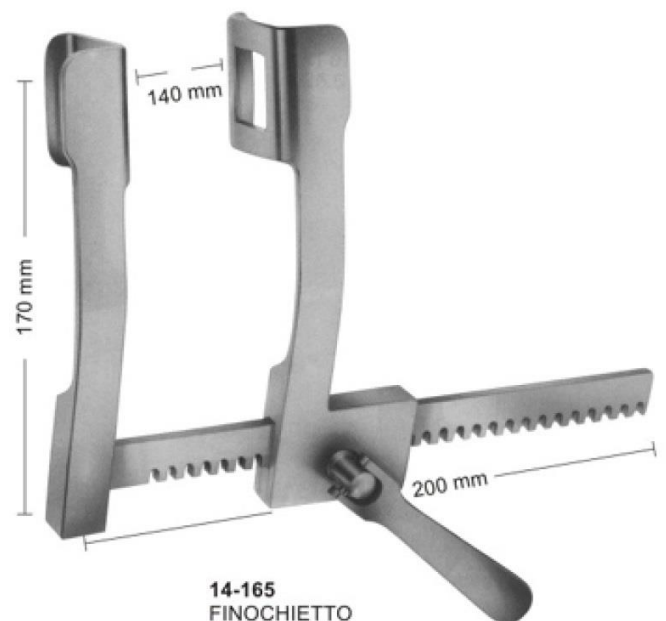

14-165
FINOCHIETTO
 Blades
 36X45 mm



$\frac{1}{2}$
14-166
SELLORS
Rib spreader-and contractor
with swivel blades
200 mm



$\frac{1}{2}$
14-167
BAILEY
150 mm



14-168
for children

14-169
for adults

$\frac{1}{2}$
14-168 - 169
BAILEY
200 mm

Punches

130° upwards cutting

15-101
 1 mm 
 KERRISON - JACOBY

FERRIS-SMITH-KERRISON

15-102
 2 mm 

15-103
 3 mm 

15-104
 4 mm 

15-105
 5 mm 

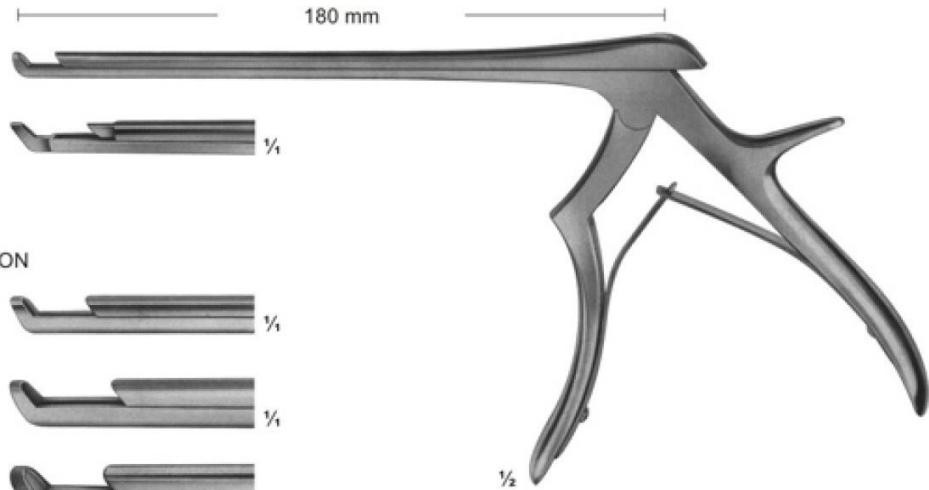

15-101 - 105

90° upwards cutting

KERRISON - JACOBY

15-106
 1 mm 

15-107
 2 mm 

FERRIS-SMITH-KERRISON

15-108
 3 mm 

15-109
 4 mm 

15-110
 5 mm 

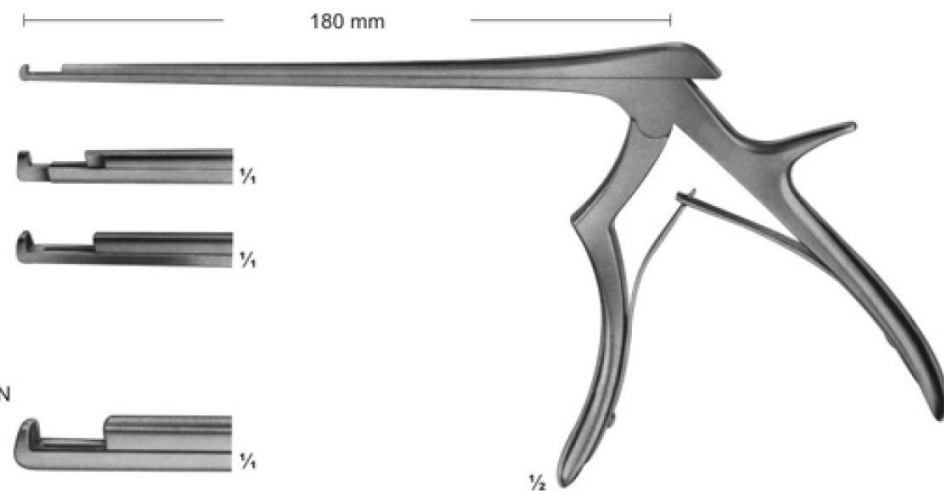

15-106 - 110

130 mm

LOVE-GRUENWALD
15-111
 2 X 10 mm

15-112
 3 X 10 mm

SPURLING
15-113
 4 X 10 mm

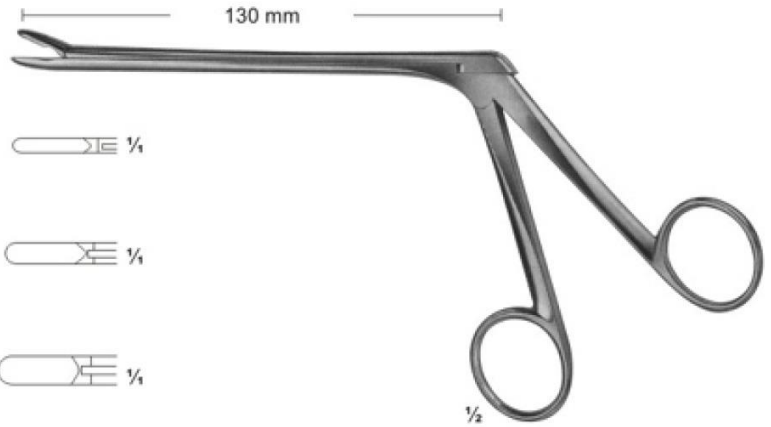

1/2

15-111 - 113

155 mm

15-114
 2 mm

15-115
 3 mm

15-116
 4 mm

15-117
 5 mm

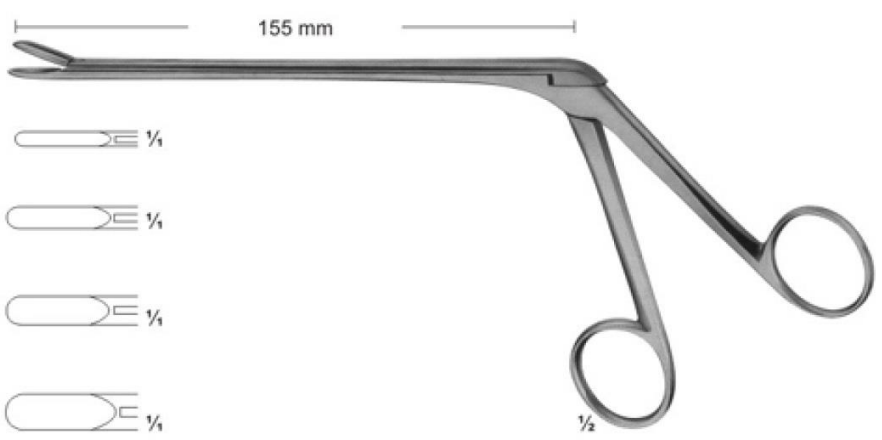

1/2

15-114 - 117
 CASPAR

150°

155 mm

15-118
 2 mm

15-119
 3 mm

15-120
 4 mm

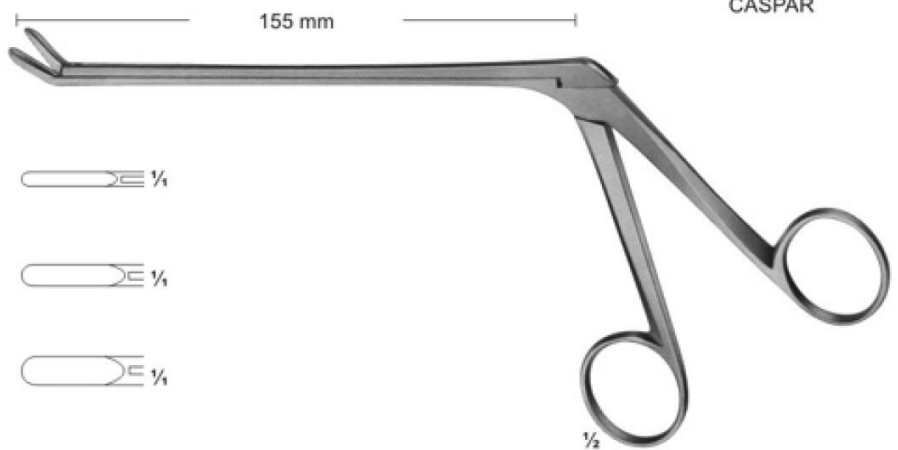

1/2

15-118 - 120
 CASPAR

Elevators and Bone Levers

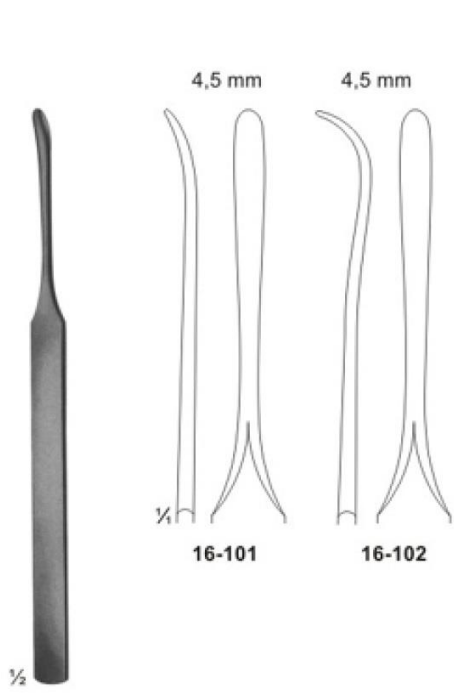

16-101 - 102
KONIG
 155 mm

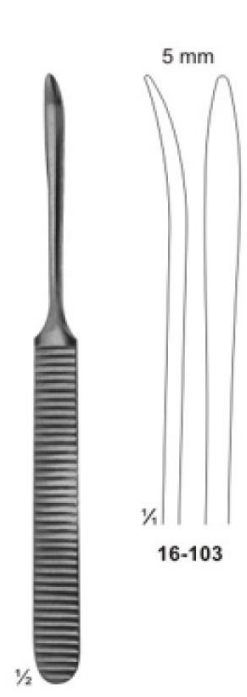

16-103
WILLIGER
 165 mm

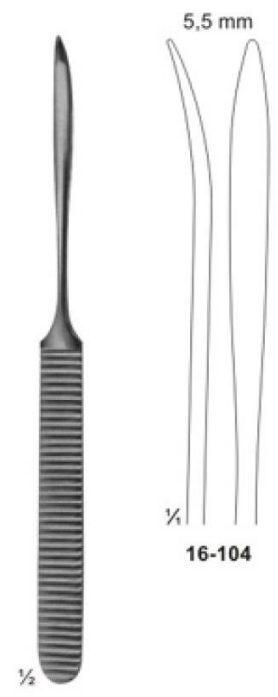

16-104
WILLIGER
 170 mm

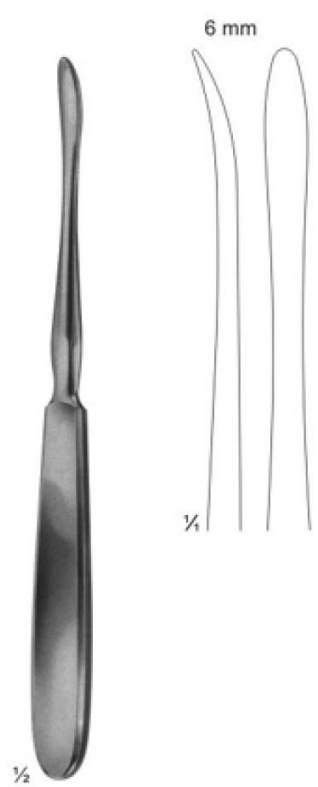

16-105
QUERVAIN
 195 mm

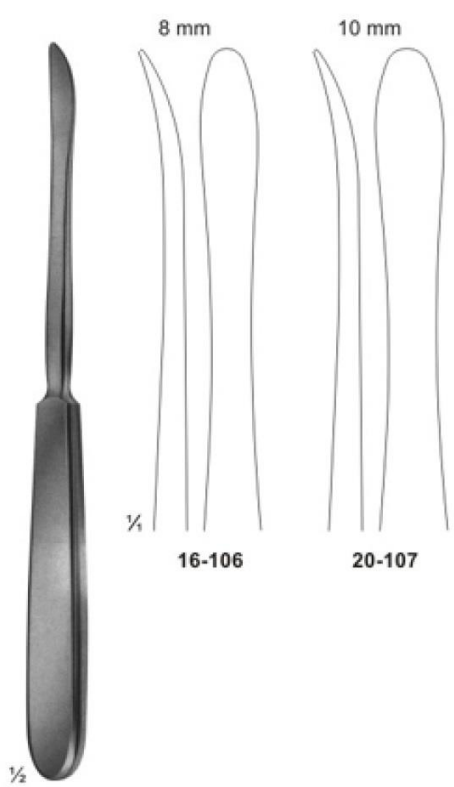

16-106 - 107
LANGENBACK
 195 mm

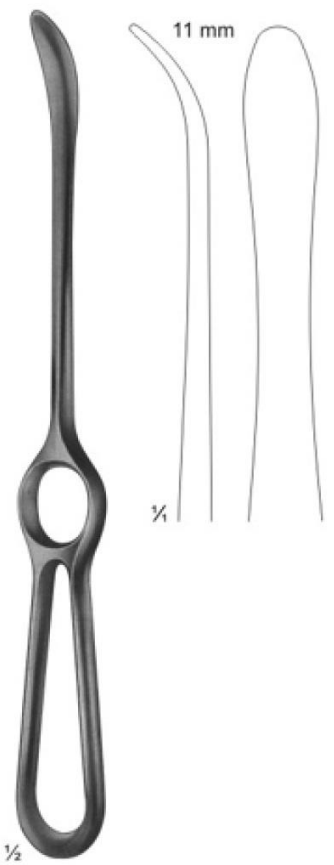

16-108
LANGENBACK
 230mm

Bone Levers



Raspatories

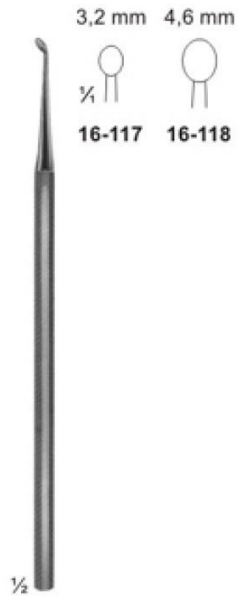

16-117 - 118
PARTSCH
 150 mm

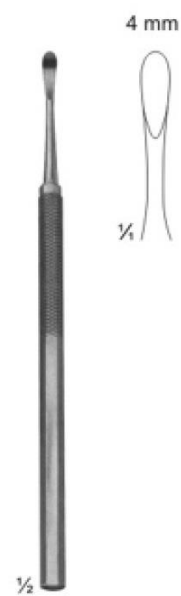

16-119
PARTSCH mod. LANGE
 145 mm

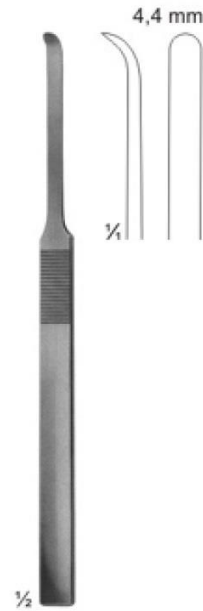

16-120
MC KENTY
 155 mm

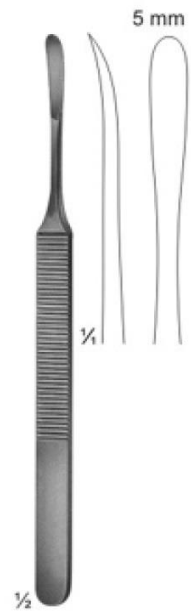

16-121
KOENIG
 155 mm

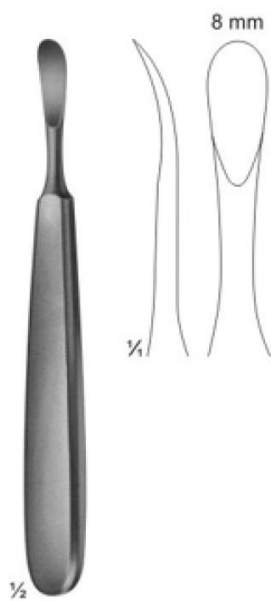

16-122
TRELAT
 150 mm

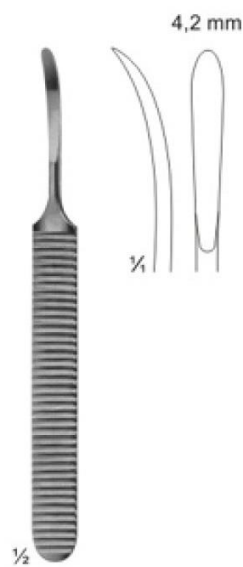

16-123
WILLIGER
 140 mm

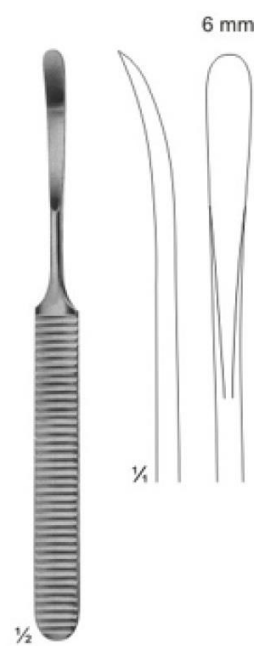

16-124
WILLIGER
 160 mm

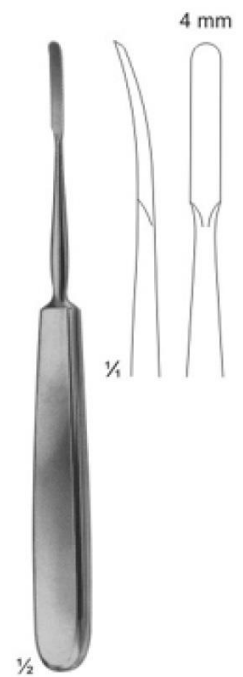

16-125
JOSEPH
 170 mm

Bone File and Rasps

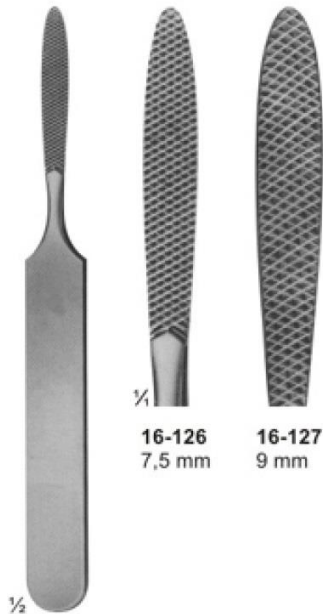

16-126
7,5 mm

16-127
9 mm

16-128
8 mm
fine teeth

16-129
8 mm
coarse teeth
175 mm

16-126
JOSEPH
fine, chequered

16-127
coarse, chequered
165 mm

16-128 - 129
LEWIS



16-130
MALTZ
down stroke
180 mm

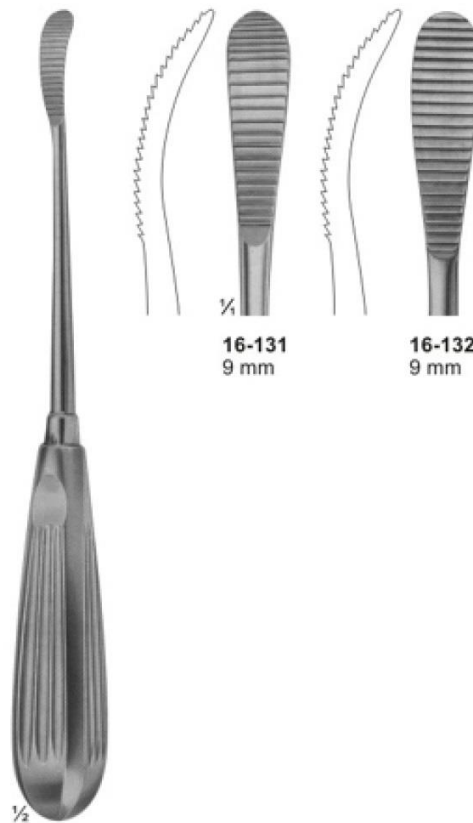

16-131
9 mm

16-132
9 mm

16-131 - 132
AUFRICHT
up stroke
16-132
down stroke
220 mm



16-133
GALLAHER
190 mm



16-134
JACOBSON
 140 mm

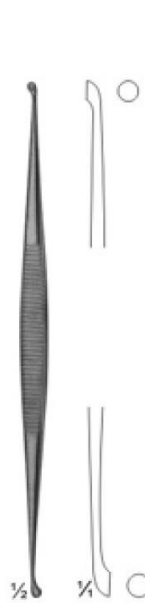

16-135
MARTINI
 140 mm



16-137
MARTINI
 140 mm



16-138
WILLIGER
 145 mm



16-139
JANSEN
 160 mm



16-140
BARTH
 180 mm

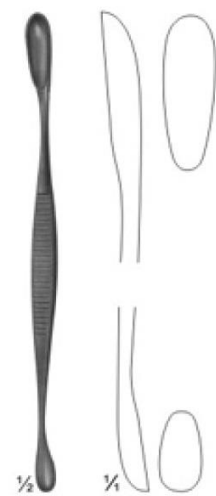

16-141
VOLKMANN
 130 mm

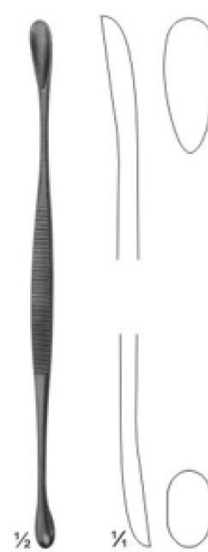

16-142
VOLKMANN
 145 mm

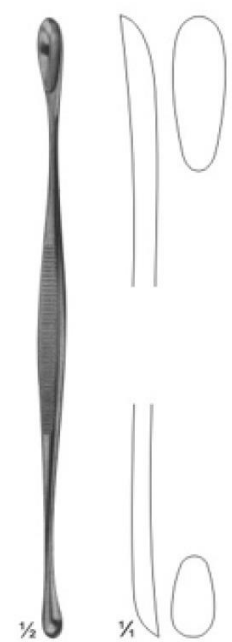

16-143
VOLKMANN
 170 mm

Mallets Weights refer to the heads of the mallets
Hammer



17-101
MEAD
185 g
with interchangeable
plastic disks
190 mm
17-102
pair of spare disks



17-103
140 g
with interchangeable
plastic disks
185 mm
17-104
pair of spare disks



17-105
COTTLE
140 g
1 Side Flat
1 Side convex
185 mm



17-106
165 g
lead filled head
190 mm

Osteotomes, Chisels and Gouges

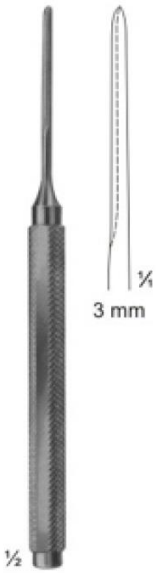

17-107
MANNERFELT
 Gouge
 155 mm

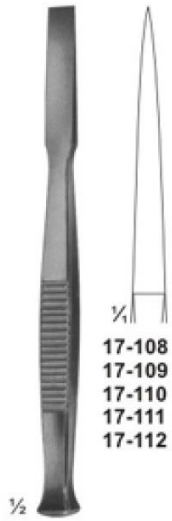

17-108 - 112
Osteotomes
 140 mm

- 17-108** 4 mm
- 17-109** 6 mm
- 17-110** 8 mm
- 17-111** 10 mm
- 17-112** 12 mm

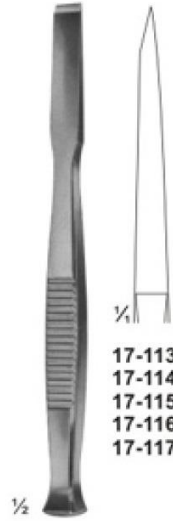

17-113 - 117
Chisels
 140 mm

- 17-113** 4 mm
- 17-114** 6 mm
- 17-115** 8 mm
- 17-116** 10 mm
- 17-117** 12 mm

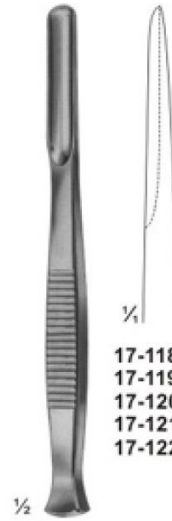

17-118 - 122
Gouges
 140 mm

- 17-118** 4 mm
- 17-119** 6 mm
- 17-120** 8 mm
- 17-121** 10 mm
- 17-122** 12 mm

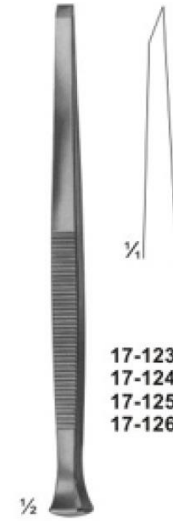

PARTSCH
17-123 - 126
Chisels
 140 mm

- 17-123** 3 mm
- 17-124** 4 mm
- 17-125** 5 mm
- 17-126** 6 mm

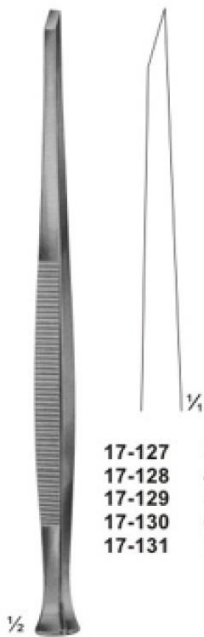

PARTSCH
17-127 - 131
Chisels
 170 mm

- 17-127** 3 mm
- 17-128** 4 mm
- 17-129** 5 mm
- 17-130** 6 mm
- 17-131** 7 mm



PARTSCH
17-132 - 135
Gouges
 140 mm

- 17-132** 3 mm
- 17-133** 4 mm
- 17-134** 5 mm
- 17-135** 6 mm

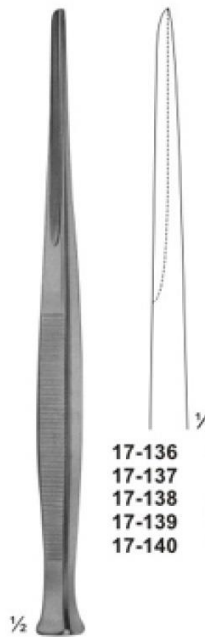

PARTSCH
17-136 - 140
Gouges
 170 mm

- 17-136** 3 mm
- 17-137** 4 mm
- 17-138** 5 mm
- 17-139** 6 mm
- 17-140** 7 mm



LUCAS
17-141 - 142
Chisels
 160 mm

- 17-141** 4 mm
- 17-142** 6 mm

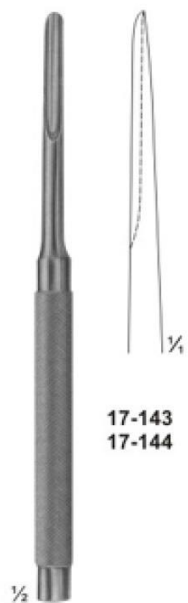

LUCAS
17-143 - 144
Gouges
 160 mm

- 17-143** 3 mm
- 17-144** 5 mm

Reposition Forceps, Bone Holding Forceps



17-145
 Patella forceps
 185 mm



17-146
 Forceps with
 ratchet fixation
 140 mm



17-147
 Forceps with
 thread fixation
 170 mm



17-148
 Forceps with
 thread fixation
 235 mm

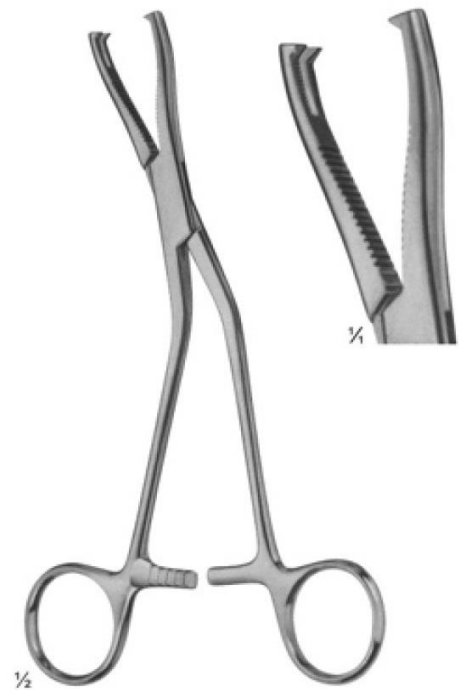

17-149
 DINGMANN
 185 mm

Bone Holding Forceps

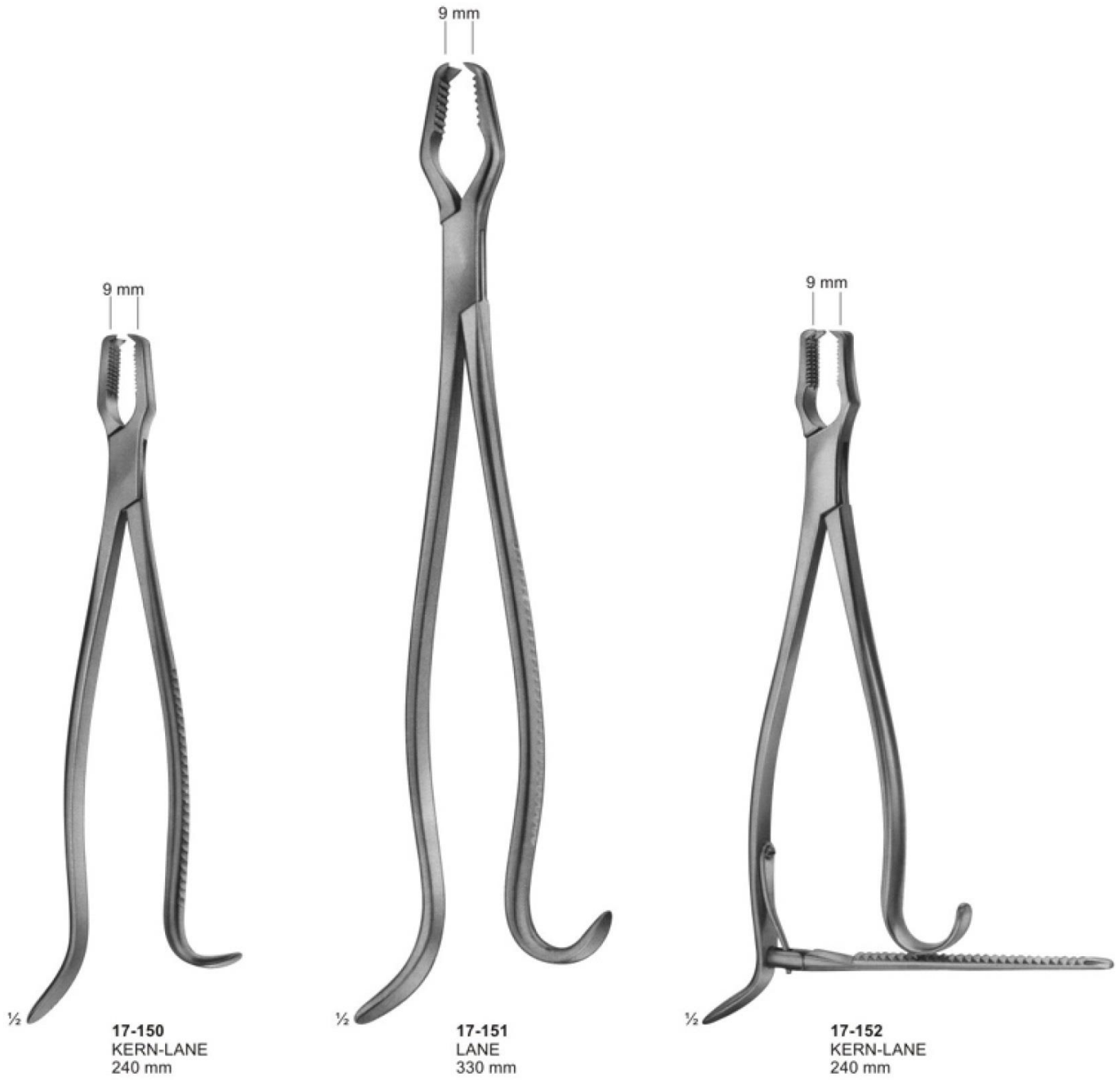



17-153 - 154
LOWMAN
17-153 170 mm
17-154 205 mm



17-155
LOWMAN-GERSTER
210 mm



17-156
LOWMAN-HOGLUND
175 mm



17-157
LUER
150 mm

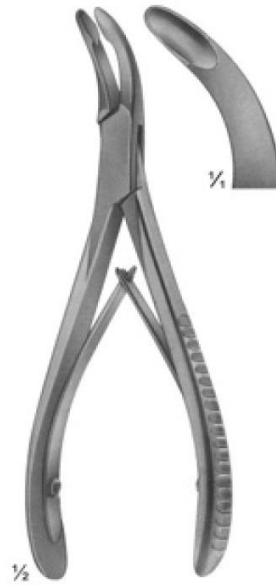

17-158
LUER
155 mm

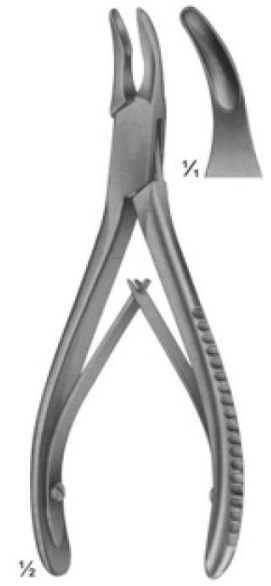

17-159
BLUMENTHAL
155 mm



17-160
BLUMENTHAL
150 mm

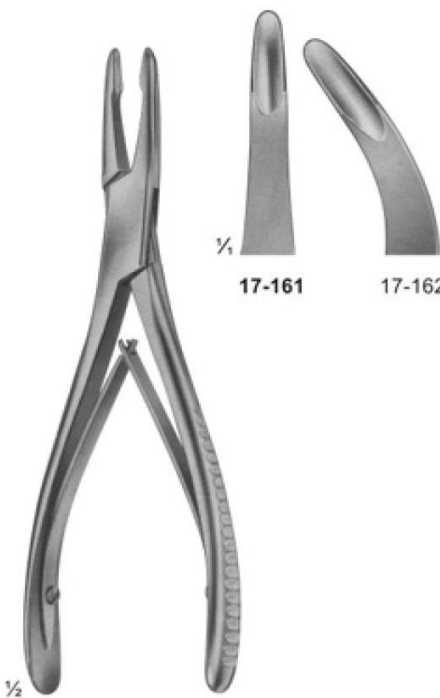

17-161 - 162
JANSEN
175 mm

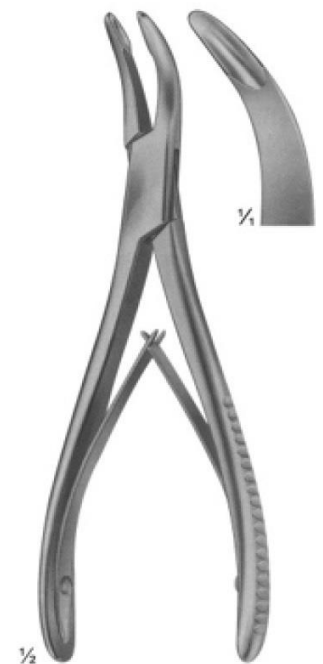

17-163
BANE-HARTMANN
175 mm



17-164
STILLE
235 mm



17-165
LEKSELL-STILLE
240mm

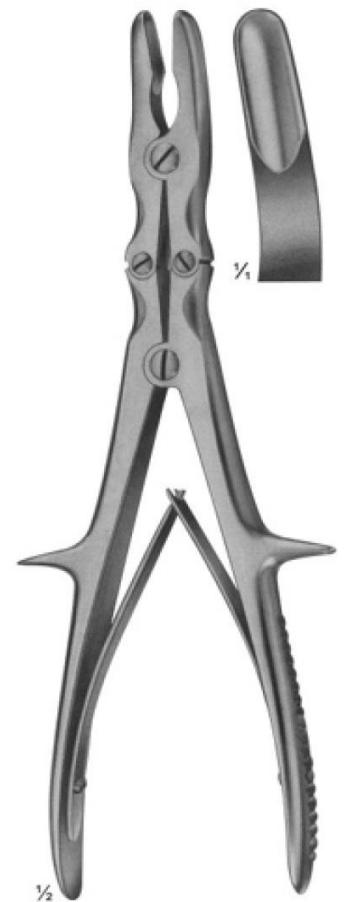

17-166
STILLE-RUSKIN
240mm

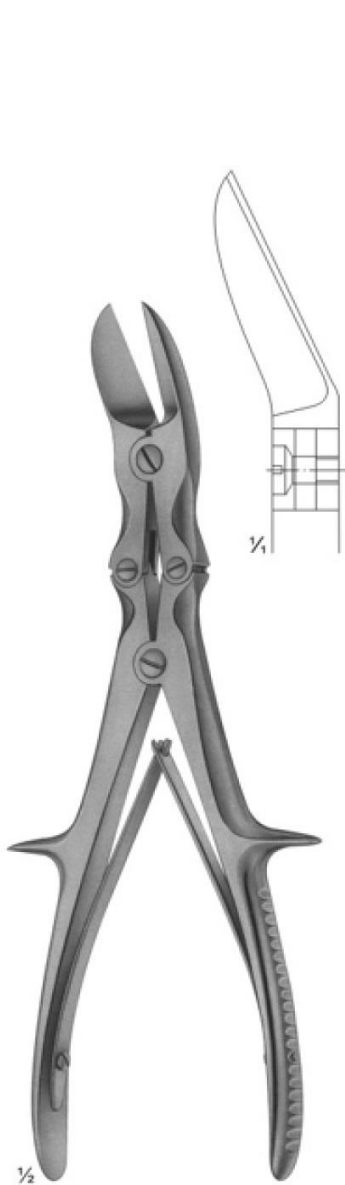

17-167
LISTON
curved on flat
240 mm

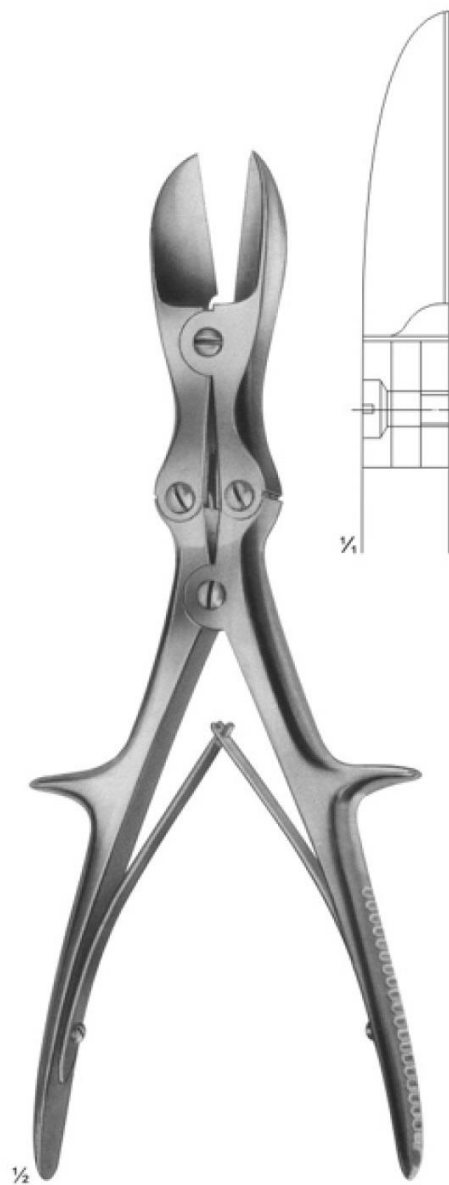

17-168
LISTON
straight
280 mm

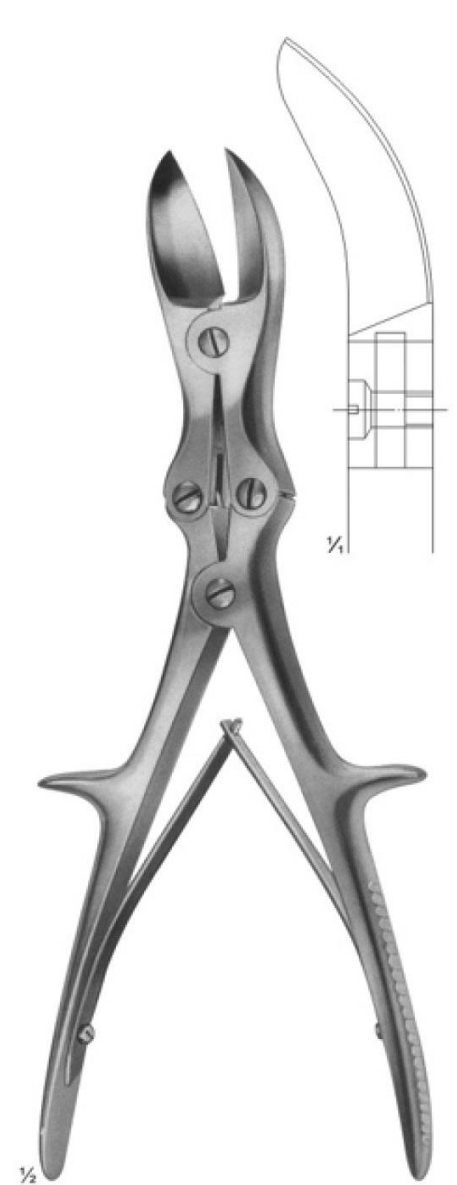

17-169
LISTON
curved on flat
280 mm



17-170
STILLE-AESCU LAP
260 mm



17-171
STILLE-AESCU LAP
360 mm



17-172
HENING
270 mm



17-173
MOD.USA
230 mm



17-174
290 mm



with removable jaws



17-175 - 176
WOLFF
17-175 180 mm
17-176 240 mm
plaster breakers

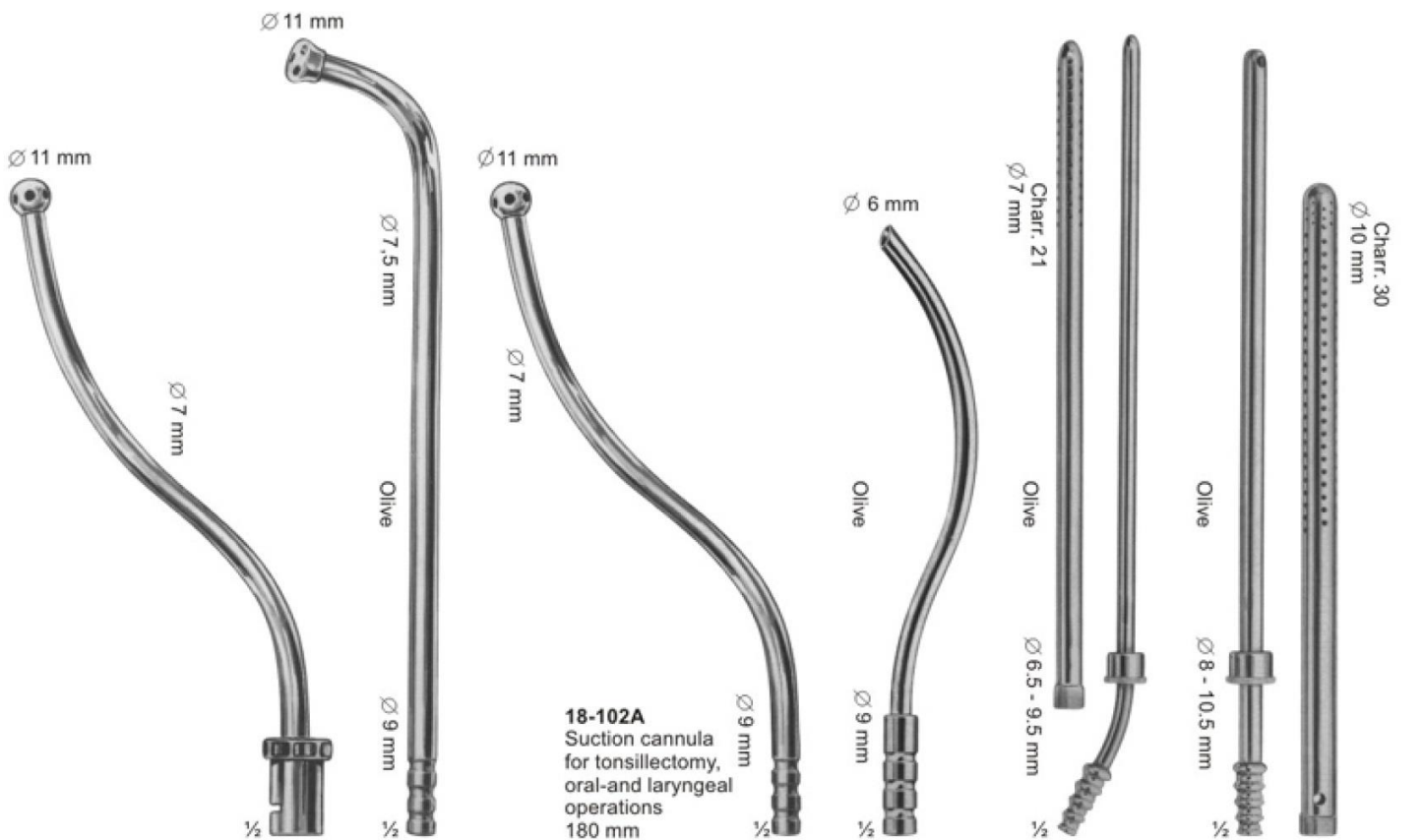

18-101
For tonsillectomy,
oral-and laryngeal
operations
180 mm

18-102
Suction cannula
for tonsillectomy,
oral-and laryngeal
operations
220 mm

18-102A
Suction cannula
for tonsillectomy,
oral-and laryngeal
operations
180 mm

18-103
S-shaped blunt cannula
for aspirating fluid from
the excretory ducts of
large glands and for
keeping the operating
area clear
170 mm

18-104
POOL
Suction cannula,
with outer tube
to be screwed of
225 mm

18-105
POOL
Suction cannula,
with outer tube
to be screwed off
225 mm

Suction Instruments

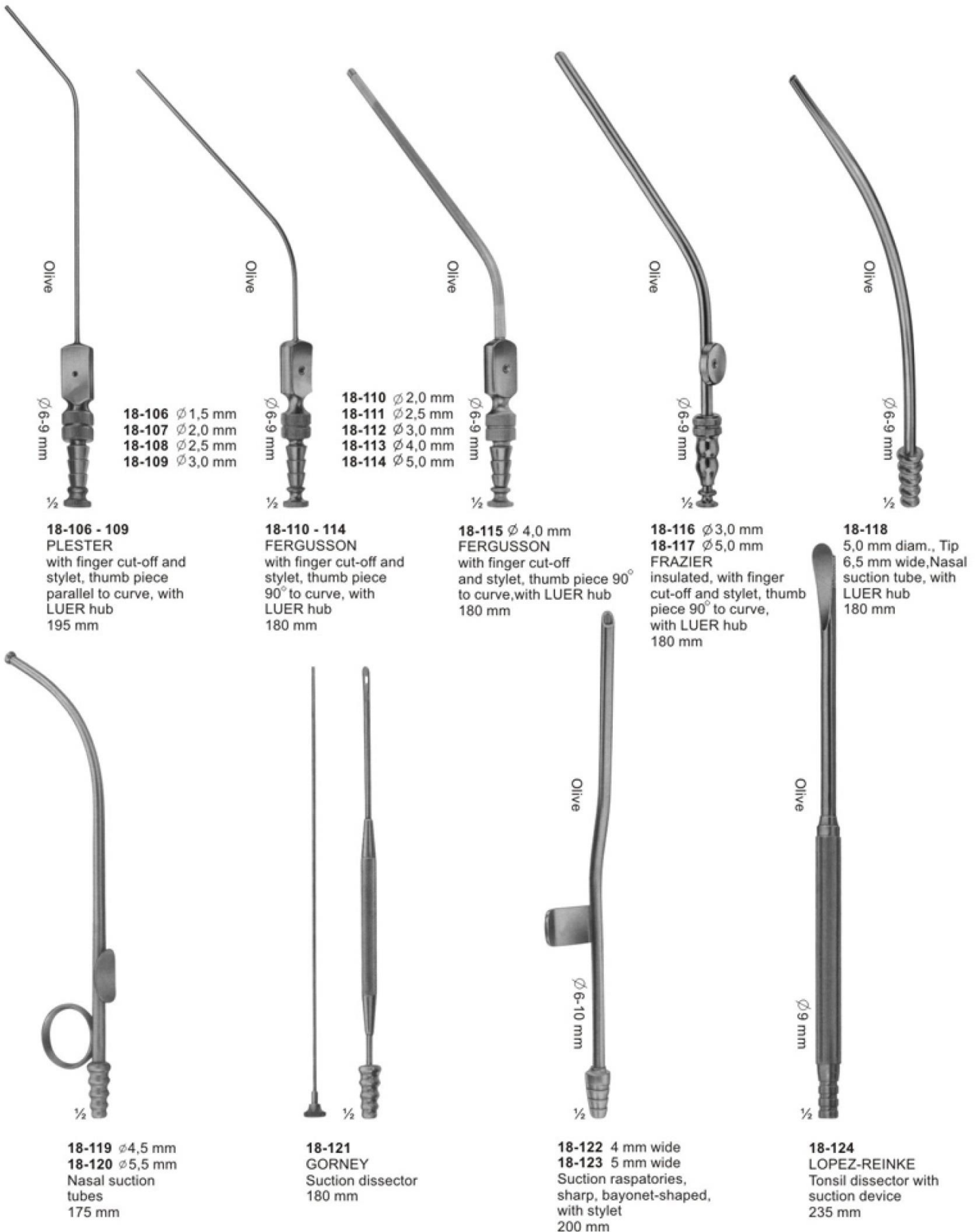

Olive

Ø 6-9 mm

- 18-106 Ø 1,5 mm
- 18-107 Ø 2,0 mm
- 18-108 Ø 2,5 mm
- 18-109 Ø 3,0 mm

½

18-106 - 109
PLESTER
 with finger cut-off and stylet, thumb piece parallel to curve, with LUER hub
 195 mm

Olive

Ø 6-9 mm

- 18-110 Ø 2,0 mm
- 18-111 Ø 2,5 mm
- 18-112 Ø 3,0 mm
- 18-113 Ø 4,0 mm
- 18-114 Ø 5,0 mm

½

18-110 - 114
FERGUSSON
 with finger cut-off and stylet, thumb piece 90° to curve, with LUER hub
 180 mm

Olive

Ø 6-9 mm

18-115 Ø 4,0 mm
FERGUSSON
 with finger cut-off and stylet, thumb piece 90° to curve, with LUER hub
 180 mm

Olive

Ø 6-9 mm

18-116 Ø 3,0 mm
18-117 Ø 5,0 mm
FRAZIER
 insulated, with finger cut-off and stylet, thumb piece 90° to curve, with LUER hub
 180 mm

Olive

Ø 6-9 mm

18-118
 5,0 mm diam., Tip 6,5 mm wide, Nasal suction tube, with LUER hub
 180 mm



½

18-119 Ø 4,5 mm
18-120 Ø 5,5 mm
 Nasal suction tubes
 175 mm



½

18-121
GORNEY
 Suction dissector
 180 mm



Olive

Ø 6-10 mm

½

18-122 4 mm wide
18-123 5 mm wide
 Suction raspatories, sharp, bayonet-shaped, with stylet
 200 mm



Olive

Ø 9 mm

½

18-124
LOPEZ-REINKE
 Tonsil dissector with suction device
 235 mm



19-101 - 115
Schimmelbusch

	Ø x H sizes in mm
19-101	80 x 80
19-102	120 x 120
19-103	140 x 140
19-104	160 x 120
19-105	160 x 150
19-106	190 x 150
19-107	190 x 190
19-108	240 x 160
19-109	240 x 240
19-110	290 x 160
19-111	290 x 240
19-112	340 x 160
19-113	340 x 240
19-114	390 x 190
19-115	390 x 290



19-116
Box
(without Bulldog clamps,
without silicone tape)



19-117
Box with support
120 x 65 x 13 mm
(ohne Bulldogklemmen)



19-118
Box with support for
needle electrodes,
without instruments

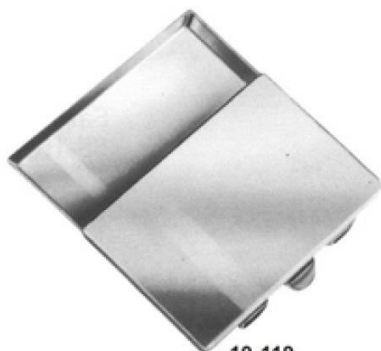

19-119
50 x 25 x 4,5 mm
19-120
65 x 42 x 8 mm
19-121
75 x 25 x 4,5 mm



19-122
Ø 65 mm x 15 mm

Hospital Wares



19-123-131

	∅ x H
19-123	30 x 90 mm
19-124	50 x 100 mm
19-125	50 x 130 mm
19-126	50 x 175 mm
19-127	50 x 100 mm
19-128	75 x 130 mm
19-129	75 x 175 mm
19-130	100 x 175 mm
19-131	100 x 200 mm



19-132-139

19-132	165 x 85 x 35 mm
19-133	200 x 100 x 35 mm
19-134	200 x 100 x 50 mm
19-135	230 x 130 x 50 mm
19-136	260 x 150 x 50 mm
19-137	270 x 235 x 50 mm
19-138	300 x 200 x 50 mm
19-139	235 x 275 x 50 mm



19-140
 205 x 105 x 35 mm



19-141-142

- 19-141** Martin Sterilizing Forceps
consisting of:
1 Sterilizing Forceps, curved, 25 cm,
without ratchet, with lid for jar
1 jar with bottom plate (anti-tilt)
- 19-142** ditto, with 32 cm long Sterilizing Forceps

Round Metal Boxes and Medicine Cups



19-143-148

	Ø x H
19-143	75 x 60 mm
19-144	75 x 75 mm
19-145	100 x 60 mm
19-146	100 x 100 mm
19-146A	125 x 80 mm
19-147	125 x 125 mm
19-148	150 x 150 mm



19-149
25 cc

19-150
50 cc



19-151
20 cc
Medicine Spoon



19-152
Ø 75 x 12 mm
Tablet Tray



19-153
Ø 90 x 90 mm
Metal Cup



19-154
Ø 75 x 80 mm
Sputum Cup



Kidney Dish



19-155 - 157

19-155	170 x 100 x 35 mm
19-156	250 x 140 x 40 mm
19-157	275 x 150 x 45 mm

Hospital Wares



19-158 - 165

	∅ x H	
19-158	40 x 19 mm	0.05L
19-159	61 x 30 mm	0.07L
19-160	80 x 40 mm	0.14L
19-161	116 x 50 mm	0.35L
19-162	128 x 55 mm	0.45L
19-163	147 x 65 mm	0.70L
19-164	167 x 75 mm	1.10L
19-165	187 x 85 mm	1.60L



19-166 - 170

19-166	116 x 35 mm	0.30L
19-167	128 x 38 mm	0.40L
19-168	147 x 40 mm	0.50L
19-169	157 x 45 mm	0.75L
19-170	187 x 45 mm	1.00L



19-171
 ∅ 100 x 28 mm 0.15L



19-172
 100 cc 0.1L



19-173 - 176

19-173	0,25L
19-174	0,50L
19-175	1,00L
19-176	2,00L



26-186
 235 x 190 x 40 mm



26-187
 ∅ 220 x 70 mm

Hospital Wares



19-179
 ∅ 50 x 100 mm
 Powder Pot



19-180
 ∅ 50 x 75 mm
 Methot With Lid



19-181
 ∅ 50 x 75 mm
 Methot Without Lid



19-182



19-183



19-184

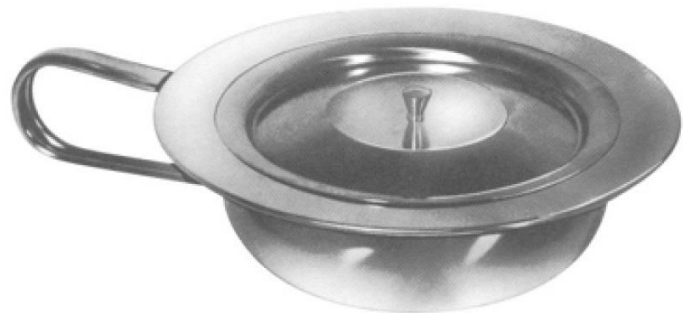

19-185-186

19-185 ∅235 mm
19-186 ∅310 mm

Needle Cases



19-187
 Sauerbruch
 210 x 125 x 17 mm



19-188
 Sauerbruch
 210 x 125 x 17 mm



19-189
 150 x 95 x 13 mm



19-190
 150 x 95 x 13 mm



19-191
 150 x 95 x 13 mm



19-192
 150 x 95 x 13 mm



19-193
 150 x 95 x 13 mm



19-194
 150 x 95 x 13 mm



19-195
 150 x 95 x 13 mm

Storing Cases



19-196
Deponette
245 x 135 x 35mm



19-197
Deponette
245 x 135 x 50mm



19-198
Deponette
245 x 135 x 60mm

Storing Cases



19-199 - 209

19-199	230 x 130 x 50 mm
19-200	260 x 150 x 50 mm
19-201	275 x 235 x 50 mm
19-202	300 x 200 x 50 mm
19-203	325 x 275 x 50 mm
19-204	420 x 175 x 50 mm
19-205	230 x 130 x 75 mm
19-206	260 x 150 x 75 mm
19-207	300 x 200 x 75 mm
19-208	325 x 275 x 75 mm
19-209	420 x 175 x 75 mm

Sterilizing Baskets / Trays

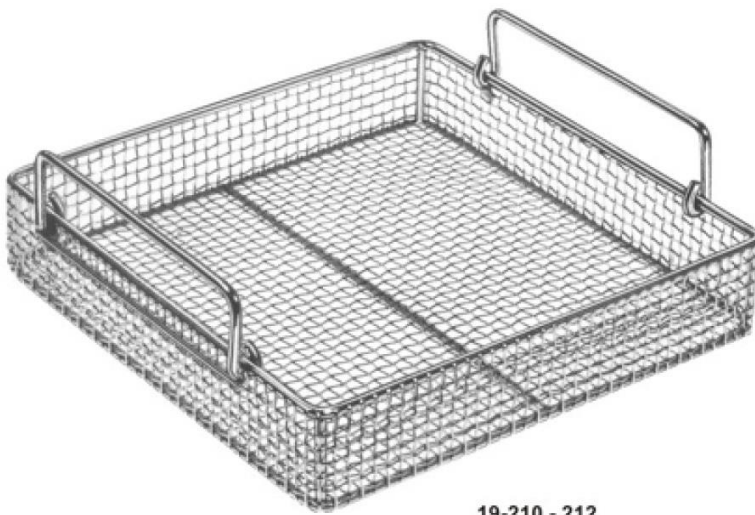

19-210 - 212

19-210	480 x 250 x 50 mm
19-211	520 x 250 x 75 mm
19-212	520 x 250 x 100 mm



19-213 - 218

19-213	240 x 240 x 50 mm
19-214	240 x 240 x 80 mm
19-215	240 x 240 x 100 mm
19-216	480 x 260 x 50 mm
19-217	520 x 260 x 80 mm
19-218	520 x 260 x 100 mm

Sterilizing Basket

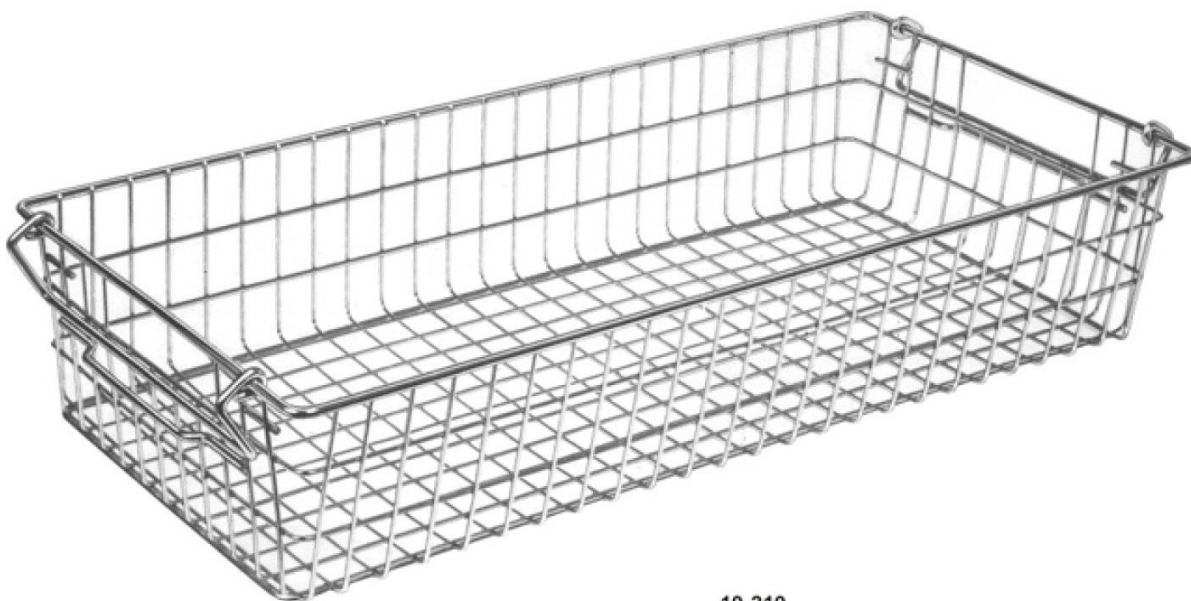

19-219
(60 x 30 x 15 cm)
Nominal dimensions

Scissors with Tungsten Carbide Inserts

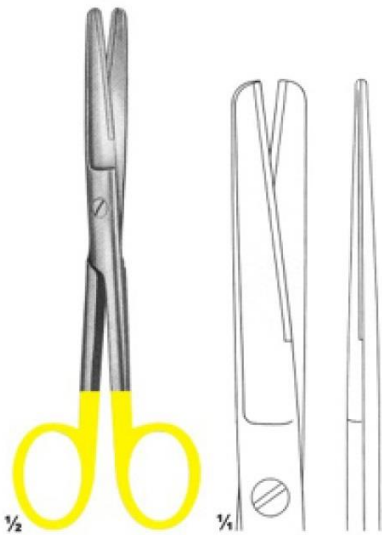

26-101
Standard

14,5cm
16,5cm
18,5cm

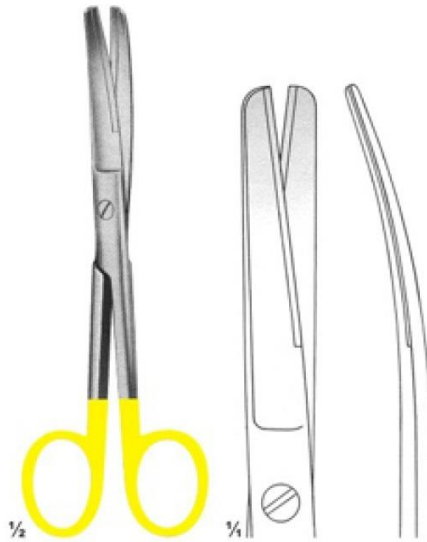

26-102
Standard

14,5cm
16,5cm
18,5cm



26-103
Standard

14,5cm
16,5cm
18,5cm



26-104
Standard

14,5cm
16,5cm
18,5cm

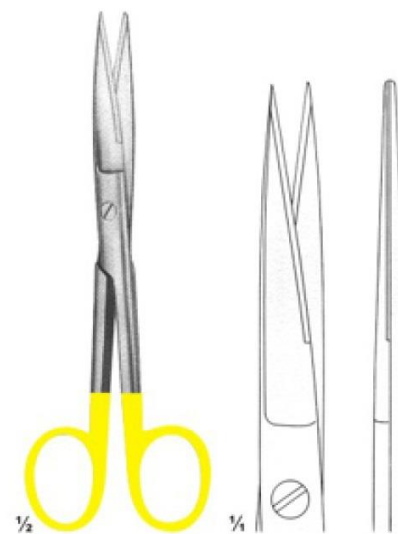

26-105
Standard

14,5cm
16,5cm
18,5cm



26-106
Standard

14,5cm
16,5cm
18,5cm

Scissors with Tungsten Carbide Inserts

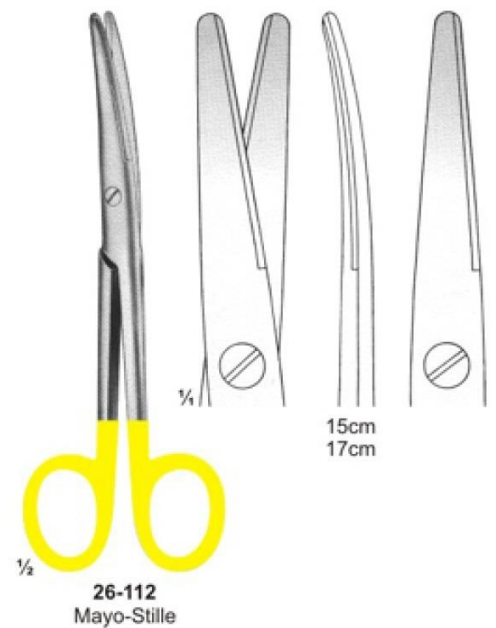
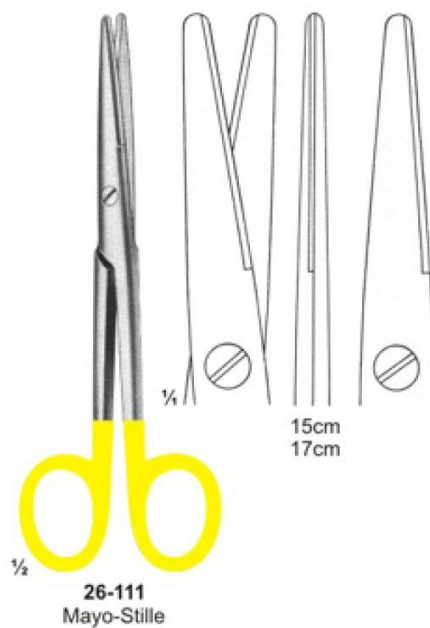
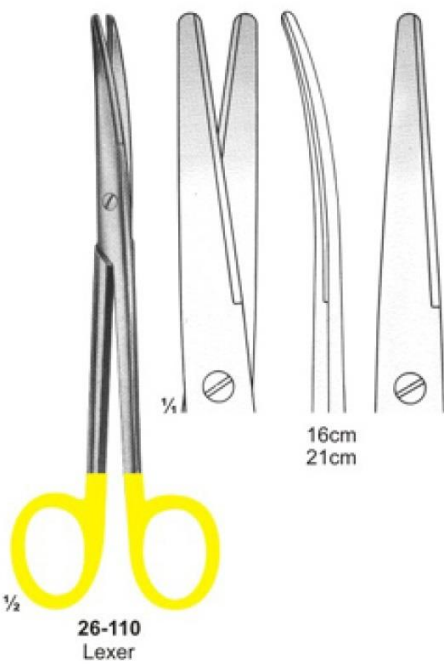
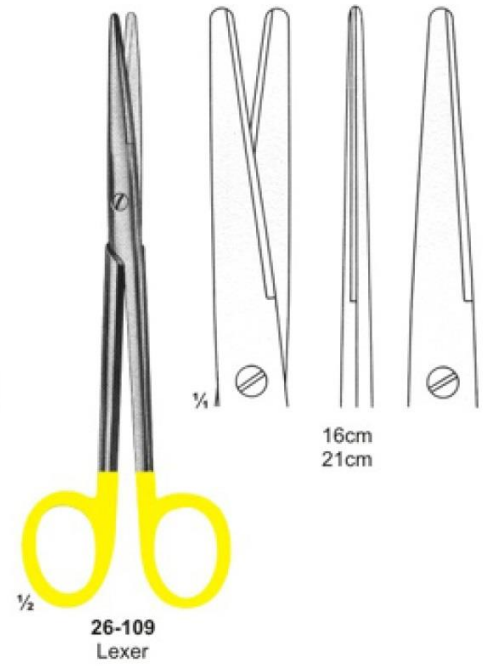
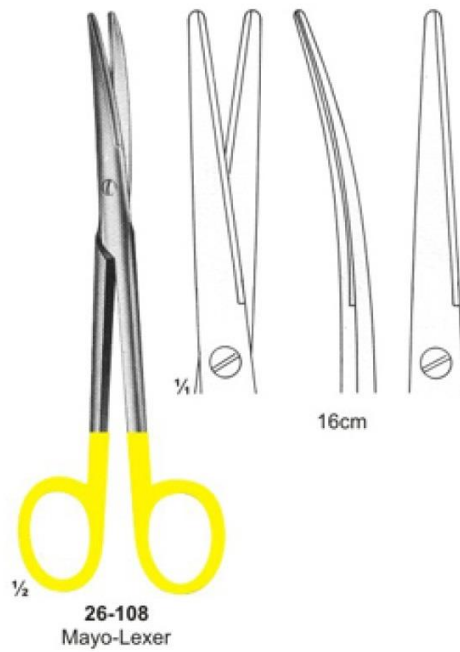

Scissors with Tungsten Carbide Inserts

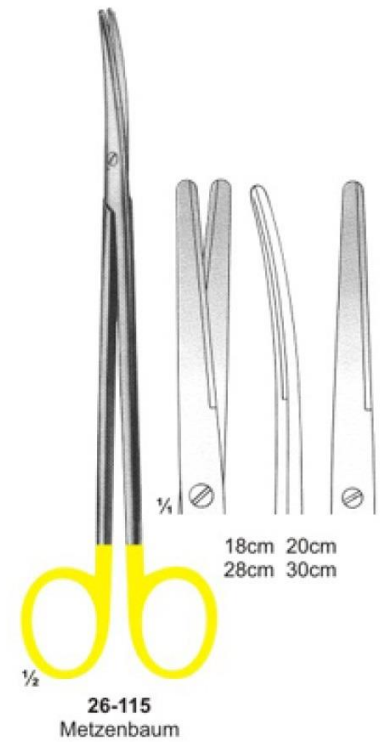
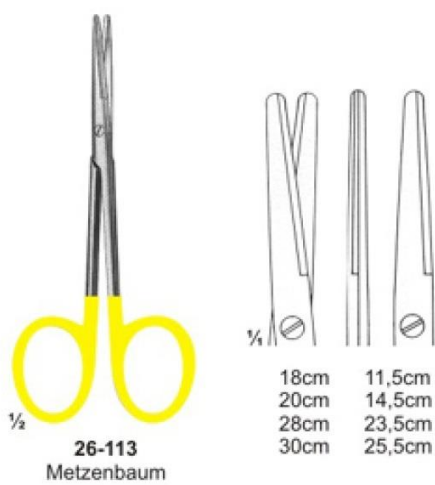

Scissors with Tungsten Carbide Inserts

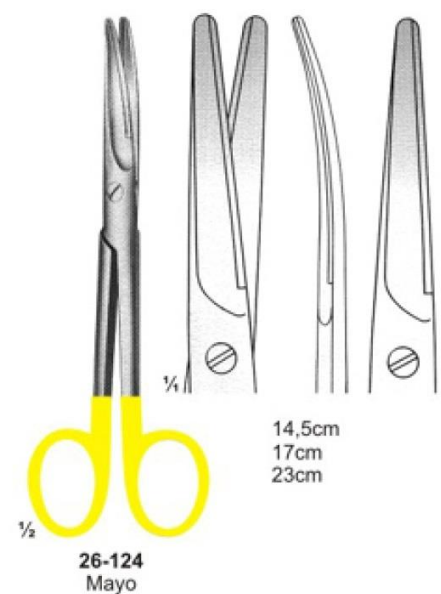
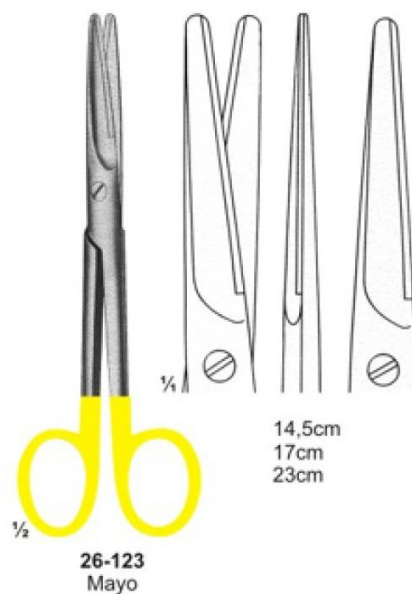
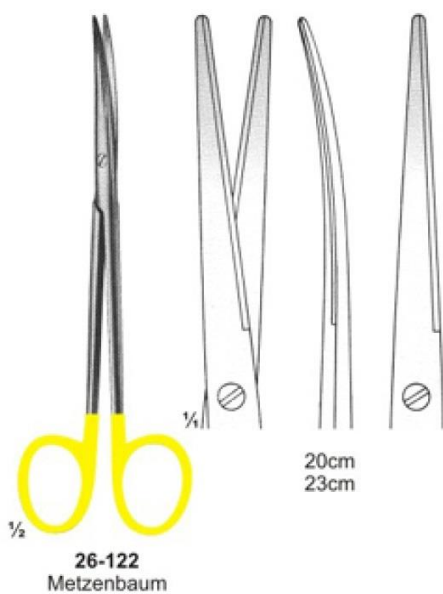
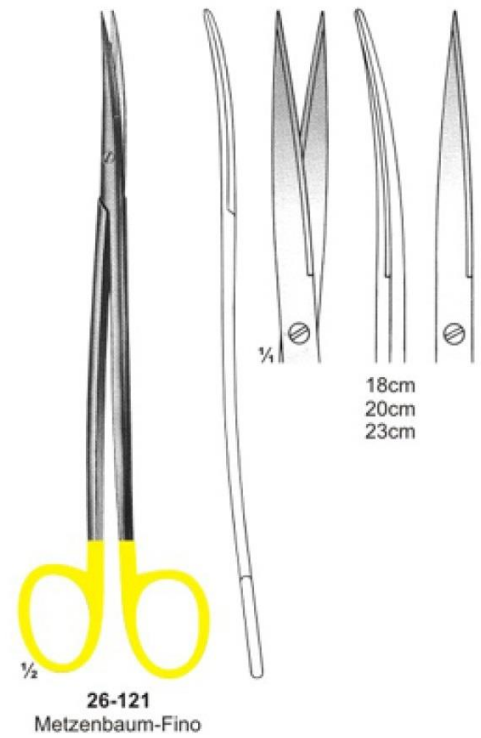
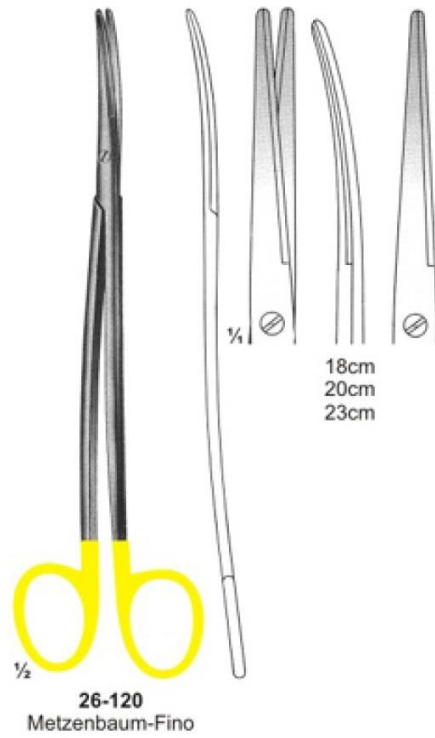

Scissors with Tungsten Carbide Inserts

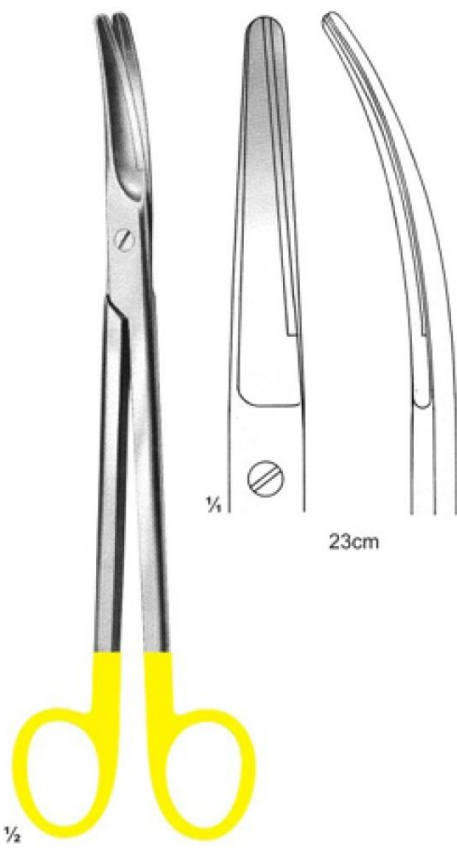

26-125
Parametrium

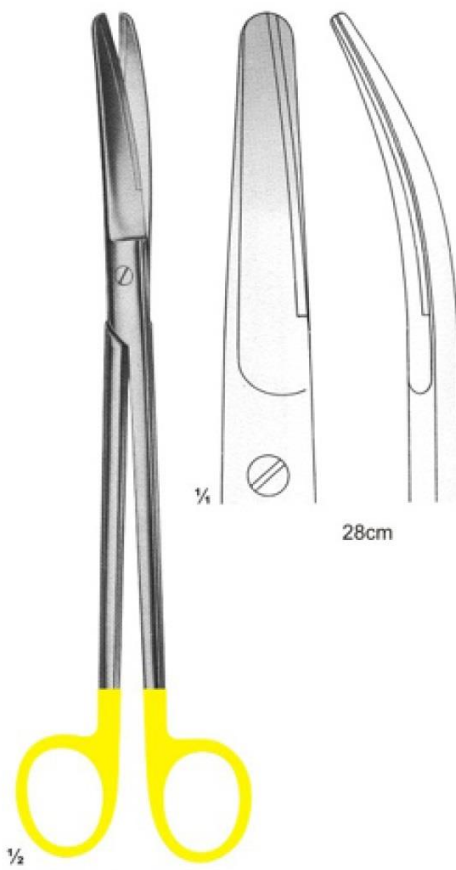

26-126
Mayo-Harrington

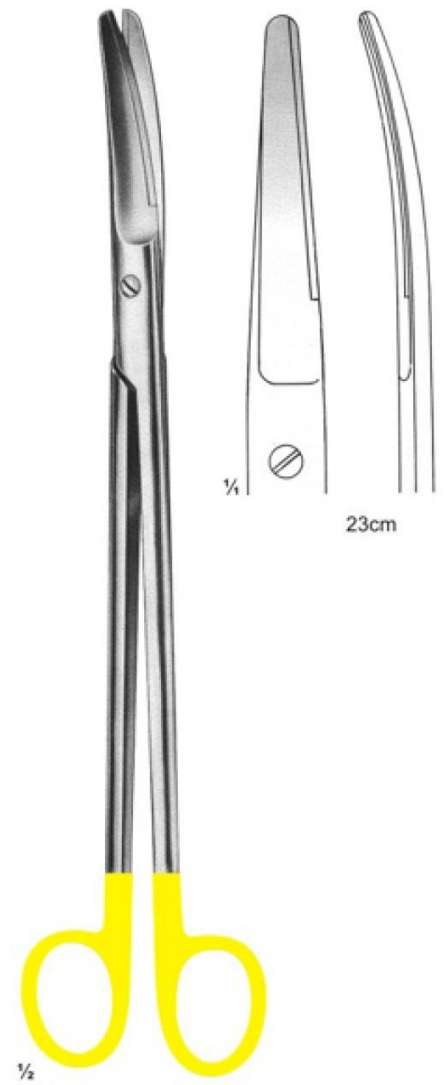

26-127
Sims

Scissors with Tungsten Carbide Inserts

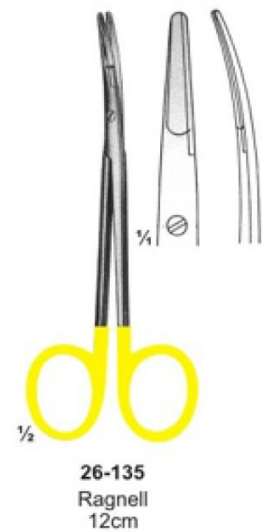
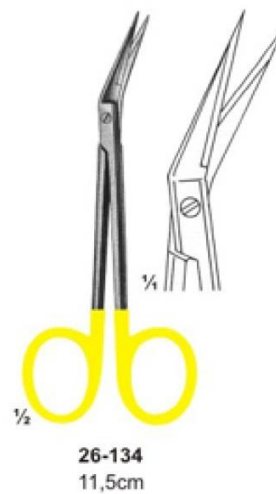
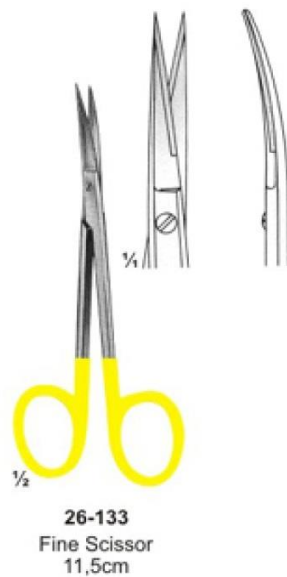
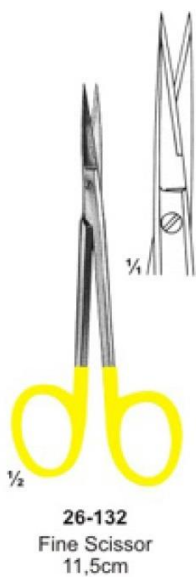
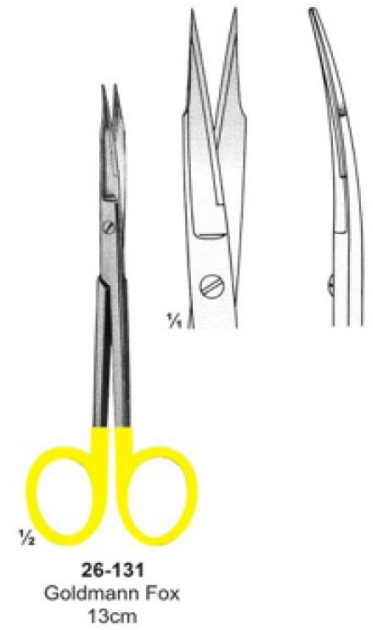
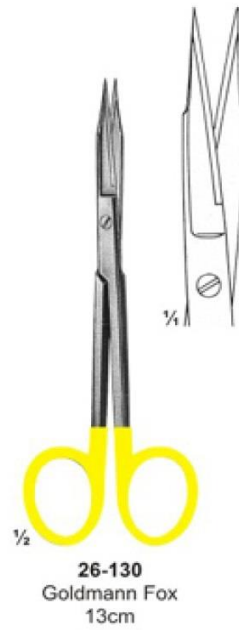
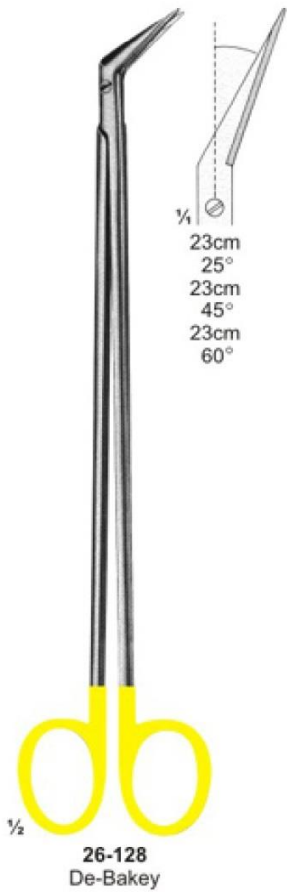

Scissors & Dissecting Forceps with Tungsten Carbide Inserts

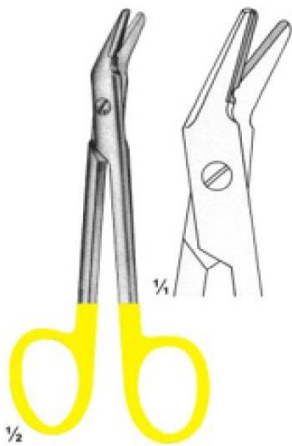

26-136
 Universal
 12cm



26-137
 Ligature Scissors
 1 Black & 1 Goldplated ring

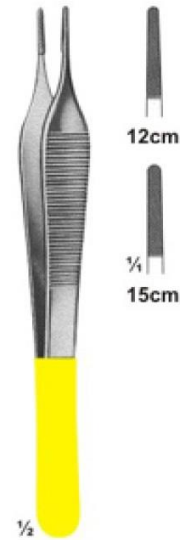

26-138
 Adson



26-139
 Cushing
 17,5cm



26-140
 Cushing
 18cm



26-141
 Cushing-Taylor
 18cm



26-142
 Dissecting Forceps
 15cm



26-143
 Semken
 15cm

Dissecting Forceps and Needle holders with Tungsten Carbide Inserts

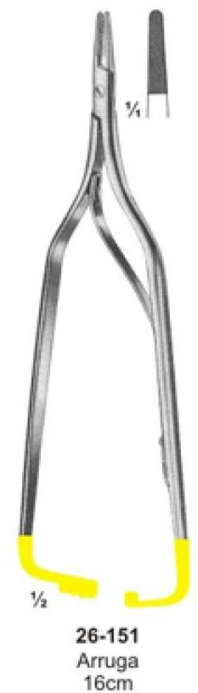
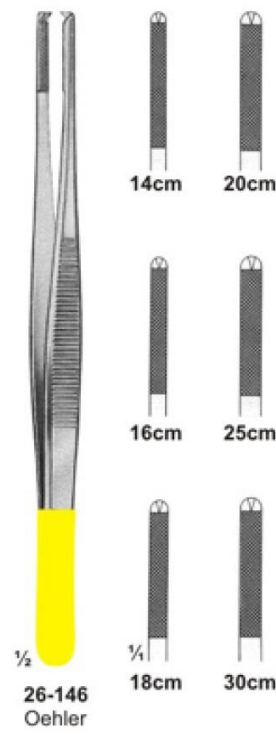
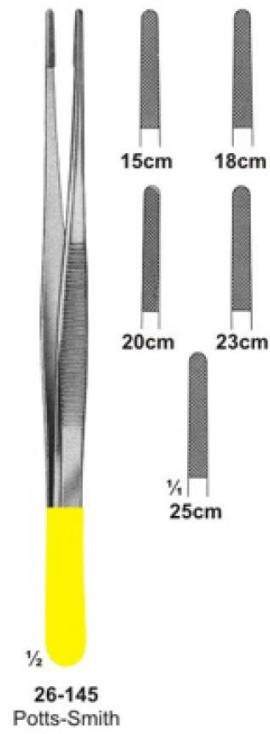
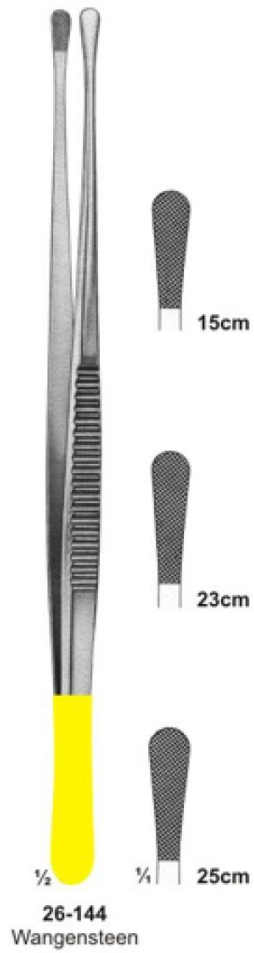

Needle holders with Tungsten Carbide Inserts

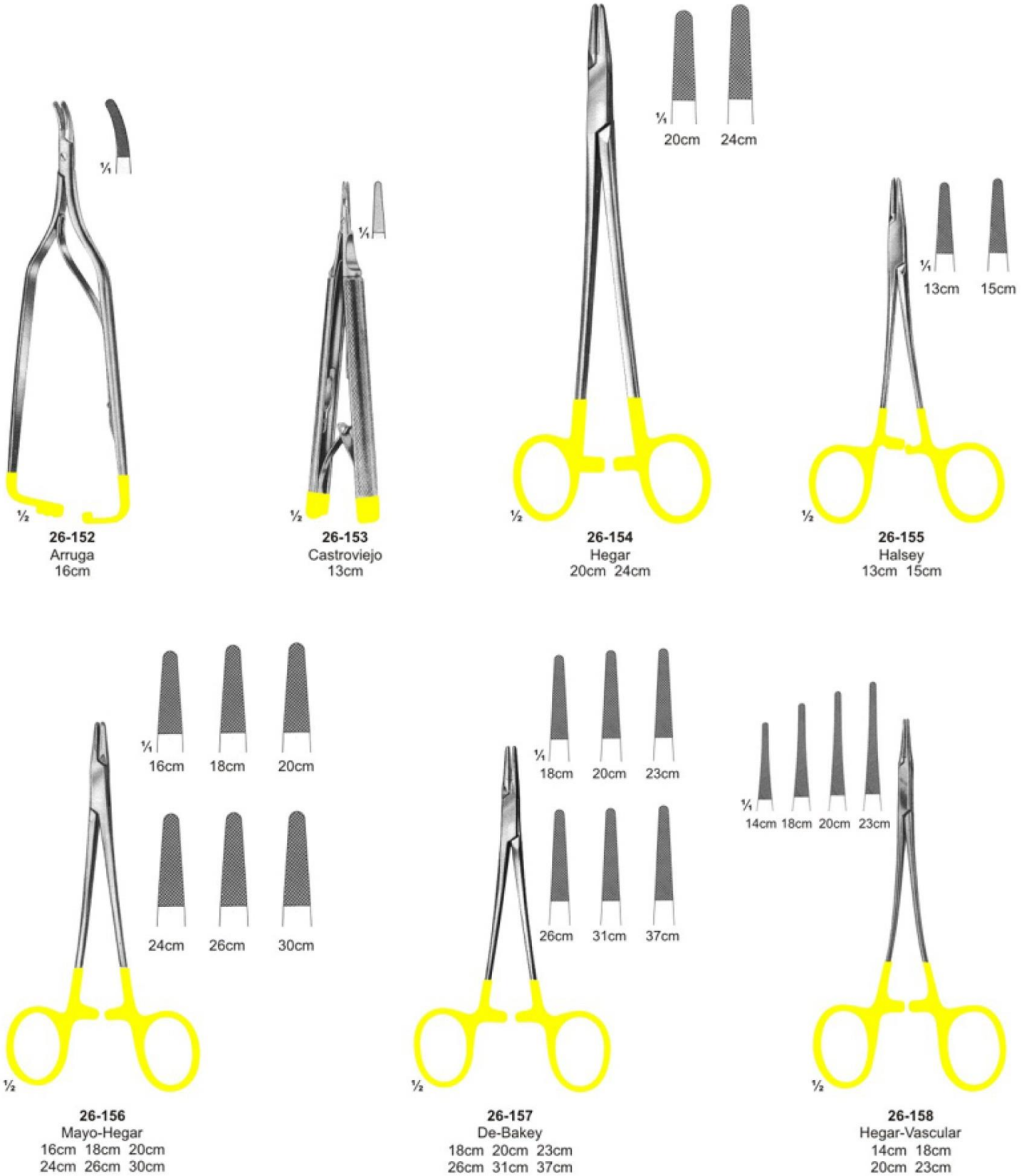

Needle holders with Tungsten Carbide Inserts

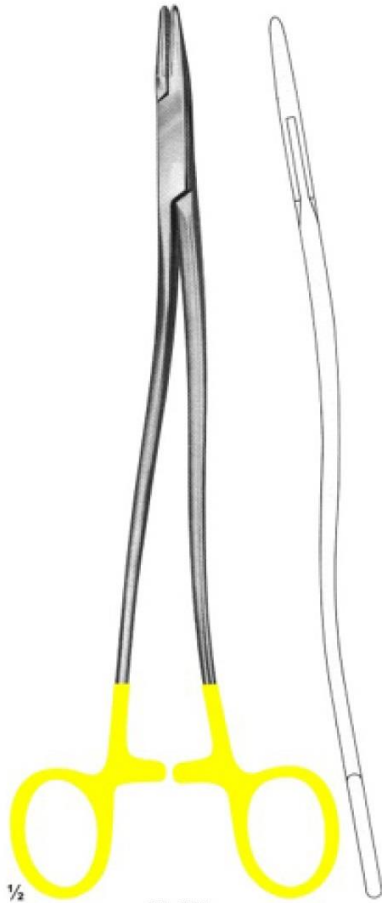

$\frac{1}{2}$
26-159
 Bozemann-Wertheim
 20cm 24cm 26cm



$\frac{1}{2}$
26-160
 Stratte
 22cm 23cm

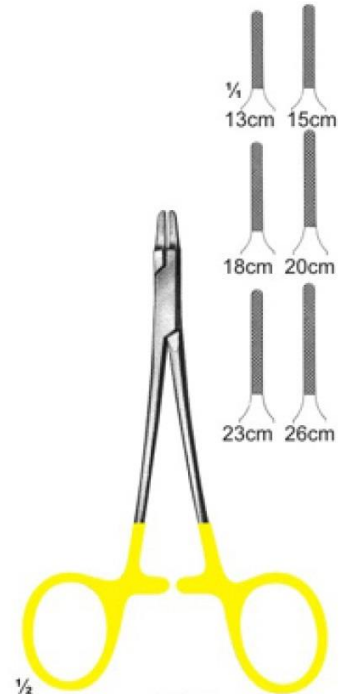

$\frac{1}{2}$
26-161
 Ryder
 13cm 15cm 18cm
 20cm 23cm 26cm



$\frac{1}{2}$
26-162
 Ryder-Vascular
 13cm 15cm 18cm
 20cm 23cm 26cm



$\frac{1}{2}$
26-163
 Martin
 15cm 17cm 20cm

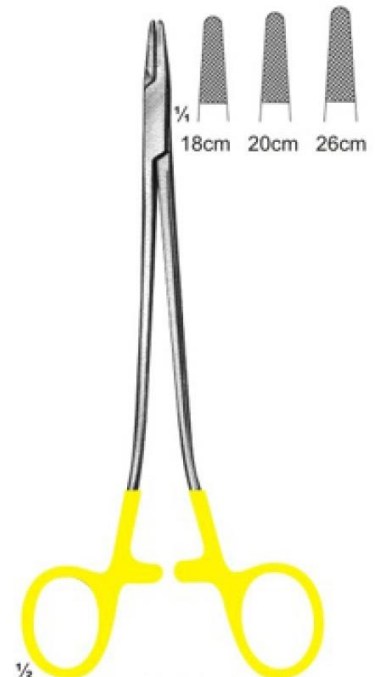

$\frac{1}{2}$
26-164
 Sarot
 18cm 20cm 26cm

Needle holders with Tungsten Carbide Inserts



Needle holders with Tungsten Carbide Inserts



$\frac{1}{2}$
26-172
 Mathieu-Ryder
 17cm
 20cm 24cm



$\frac{1}{2}$
26-173
 Lichtenberg
 20cm



$\frac{1}{2}$
26-174
 Langhals
 20cm 25cm



$\frac{1}{2}$
26-175
 Lichtenberg
 20cm 25cm



$\frac{1}{2}$
26-176
 Luehty-Beck
 20cm 25cm



$\frac{1}{2}$
26-177
 Luehty-Beck
 20cm 25cm



$\frac{1}{2}$
26-178
 Langebeck
 18cm
 20cm 23cm

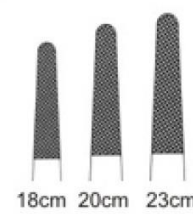

$\frac{1}{2}$
26-179
 Langebeck-beck
 18cm
 20cm 23cm

Alphabetical Index

A		C	
ABRAHAM, tonsil knife	11	CASPAR, retractor	60
ADSON, forceps	31	CASPAR, Micro scissor 115mm	14
ADSON, forceps	34	CASTROVIEJO, tissue forceps	34
ALLIS, artery traction forceps	39	CASTROVIEJO, micro spring scissor	13
ALLIS, intestinal grasping forceps	71	CASTROVIEJO, needle holder	48
ALY, aesthesiometer	01	CASTROVIEJO, eye scissor 110mm	13
AMPUTATING KNIVES	10	CASTROVIEJO, eye scissor 115mm	13
ANDREW, tongue depressor	04	CATLIN, amputating knife 160mm	10
ANESTOPHON, stethoscope	02	CHAPUT, artery traction forceps	39
ARRUGA, forceps	34	CLOWARD, lamina Spreaders	68
ARRUGA, needle holder	48	COAKLEY, antrum trocars	85
ASCH, biopsy curettes	95	COLLIN, intestinal grasping forceps	71
AUFRICHT, rasps	116	COLLIN, rib shears	108
AYRE, cone knife, 235mm	11	COLLIN, sponge and dressing forceps	38
B		COLLIN, tongue forceps	05
BABCOCK, intestinal grasping forceps	71	COLLIN, vaginal spatula	86
BABY-ALLIS, artery traction forceps	39	CONE KNIFE 235mm11	11
BACKHAUS, towel clamps	40	CONVERSE, fine wound retractor	55
BACKHAUS-KOCHER, towel clamps	40	COOLEY, multi purpose clamps	104
BAILEY, rib spreaders	110	COTTLE, retractors	57
BAKES, gall duct dilators	80	COTTLE, nasal scissor	23
BALFOUR, abdominal retractors	70	COTTLE, fine wound retractor	55
BALFOUR-BABY, abdominal retractors	69	COTTLE, mallets	118
BANE-HARTMANN, bone rongeurs	123	CRAFOORD, haemostatic forceps	42
BARTH, bone curettes	117	CRILE, needle holder	50
BEEBE wire scissor	27	CUSCO, vaginal specula	86
BEER, cilia forceps	36	CUSHING, wound and vein retractor	57
BENGOLEA, delicate forceps	42	CUSHING, dissecting forceps	32
BERGER, biopsy forceps	97	CUSHING-KOCHER, retractors	57
BERLINER, percussion hammer	01	CZERNY, gall stone forceps	81
BIEMER, vein scissor	14	CZERNY, retractors	58
BISHOP-HARMON, forceps	34	D	
BLAKE, gall stone forceps	81	DAVIDSON, scapula retractors	62
BLUMENTHAL, bone rongeurs	123	DAVIS, vascular spatulas	102
BONNEY, tissue forceps	35	DE BAKEY, forceps	33
BOSE, tracheal hooks	101	DE BAKEY, anastomosis clamps	74
BOWLES, stethoscope	02	DE BAKEY, anastomosis clamps	107
BOYS-ALLIS, artery traction forceps	39	DE BAKEY, arteriotomy scissor	20
BOZEMANN, dressing forceps	93	DE BAKEY, vana cava clamps	105
BRAUN, artery traction forceps	39	DE BAKEY, multi purpose clamps	104
BRAUN, uterine probes	92	DE BAKEY, retractors	67
BRAUN-STADLER episiotomy scissor	26	DE BAKEY, atraumata	103
BRAUN-STADLER, bandage scissors	29	DEAN, nasal and tonsil scissor	23
BRIESKY, vaginal specula	87	DEAVER, retractors	62
BRODIE, probes	52	DEAVER, surgical scissor (flat lock)	19
BROPHY, dissecting forceps	32	DE-BAKEY, bulldog clamps	41
BRUENINGS, tongue depressor	04	DEJERINE, percussion hammer	01
BRUNINGS, tonsil knife, 215mm	11	DELICATE DISSECTING FORCEPS	31
BRUNNER, retractors	61	DELICATE SCISSORS, blunt points	17
BRUNNER, rib shears	108	DELICATE SCISSORS, sharp points	16
BRUNS, plaster scissor	29	DELICATE SCISSORS, sharp points	17
BRYANT, sponge forceps	37	DENHARDT, mouth gag	05
BUCHS, retractors	60	DENIS-BROWENE, intestinal forceps	35
BUCHWALD, tongue depressor	04	DERRA, multi purpose clamps	104
BUCK, neurological hammer	01		
BUMM, ovum forceps	230		

Alphabetical Index

DESCHAMPS, ligature needles	51	GOOD, tonsil scissors	23
DESJARDINS, gall duct forceps	79	GORNEY, suction instruments	129
DESJARDINS, gall stone forceps	81	GOSSET, abdominal retractors	69
DESJARDINS, gall stone scoops	80	GRAEFE, fine wound retractor	55
DESMARRES, wound and vein retractors	57	GRAVE, vaginal specula	87
DIAGNOSTIC SETS	07	GROSS, dressing forceps	37
DICK, vaginal clamps and compression forceps	46	GUEDEL-NEGUS, laryngoscope	08
DIEFFEBACH, bulldog clamps	41	GUTHRIE, fine wound retractor	55
DINGMANN, bone holding forceps	120	GUYON, kidney clamps	82
DISSECTING KNIVES	09		
DITTEL, metal bougies	80	H	
DOYEN, abdominal retractors	64	HALLE, vascular spatulas	102
DOYEN, intestinal clamps	72	HALSTED-MOSQUITO, haemostatic forceps	42
DOYEN, ovum forceps	230	HARTMANN, intestinal clamps	72
DOYEN, probes	52	HARVEY, plate scissors	27
DOYEN, towel clamps	40	HEANEY, needle holder	49
DOYEN, vaginal specula	89	HEGAR, needle holder	49
DUPLAY, sponge and dressing forceps	37	HEGAR-OLSEN, needle holder	50
DUVAL, intestinal forceps	35	HEGER, uterine dilators	91
		HEISS, haemostatic forceps	42
E		HEISS, dressing forceps	45
EISELSBERD, needle holder	50	HEISTER, mouth gag	05
ELSCHING, forceps	34	HENING, plaster spreader	127
ENGL.MOD, towel clamps	40	HERGET, biopsy forceps	77
EPPENDORF, biopsy forceps	97	HERTZLER, abdominal retractors	69
ESMARCH, cloth and plaster scissors	29	HERTZLER, rib spreaders	109
		HESS, tissue forceps	34
F		HEYMANN-KNIGHT, scissors	23
FEILCHENELD, splinter forceps	36	HEYWOOD-SMITH, ovum forceps	94
FERGUSSON, haemorrhoidal forceps	78	HEYWOOD-SMITH, sponge holding forceps	38
FERGUSSON, suction instrument	129	HEYWOOD-SMITH, tongue forceps	05
FERGUSSON-ACKLAND, mouth gag	05	HUBER, biopsy forceps	97
FINOCHIETTO, forceps	45	HUNT, tumor & vessel forceps	30
FINOCHIETTO, rib spreader	109	HUNTER, splinter forceps	36
FINSEN, tracheal hooks	101		
FOMON, nasal scissor	23	I	
FORD-BOWLES, stethoscope	02	INGE, lamina spreaders	68
FOWLER, tonsil knife	11	INTEROSSEOUS, cartilage knife	10
FRANCKE, blood lancet	06	IVES-FANSLER, anoscopes	76
FRAZIER, fine wound retractor	55		
FRAZIER, suction instruments	129	J	
FREER, fine wound retractor	55	JACKSON BURROWS, retractors	67
FREER, vascular spatulas	102	JACOBSON, bone curettes	117
FRENZEL, tongue depressor	04	JACOBSON, needle holder	48
FRICKE, haemostatic forceps	43	JAEGAR, fine wound retractor	55
FRITSCH, retractor	64	JAMESON, dissecting scissor	20
		JAMESON, needle holder	49
G		JANSEN, bone curettes	117
GALLAHER, rasp	116	JANSEN, bone rongeurs	123
GELPI, special retractors	67	JOHNS-HOPKING, bulldog clamps	41
GELPI, vaginal retractors	90	JOLL (FRIEDMAN), retractors	67
GERALD, dissecting forceps	32	JOLL, vaginal retractors	90
GIERTZ-STILLE, rib shears	108	JONES, towel clamps	40
GILL, tissue forceps	34	JOSEPH, bone file	116
GILL-HESS, tissue forceps	34	JOSEPH, dura and skin retractor	55
GILLIES, fine wound retractor	55	JOSEPH, raspatories	115
GILLIES, needle holder	50	JUDD-MASSON, bladder retractors	84
GLOVER, bulldog clamp	41		
GLUCK, rib shears	108		

Alphabetical Index

K	
KADER, intestinal spatula	65
KALT, needle holder	48
KELLY, ovum forceps	94
KELLY, anoscopes	76
KELLY, tissue grasping forceps	38
KERN-LANE, bone holding forceps	121
KERRISON-JACOBY, punches	111
KERSTING, anastomosis forceps	74
KILLIAN, bone shear	24
KILLIAN, rectal spatula	75
KILNER, fine dissecting scissors	20
KILNER, fine wound retractor	55
KILNER, dissecting scissor	20
KLIMA ROSEGGER, trocars	85
KOCHER, retractor	57
KOCHER, bladder retractors	84
KOCHER, bone retractor	59
KOCHER, retractors	60
KOLLE, blood lancet	06
KONIG, elevators	113
KONIG, raspatories	115
KONISATION SMESSER, retractors	57
KRAUSE, biopsy tip	97
KRISTELLER, vaginal specula	87
KRISTELLER, vaginal specula	88
KRONECKER, suture instruments	51
KRONLEIN, haemostatic forceps	43
KUMMEL, intestinal spatula	65
L	
LABORDE, tracheal dilators	101
LAHEY, artery traction forceps	39
LAHEY, gall duct forceps	79
LANE TRETOWAN, bone levers	114
LANE, bone holding forceps	121
LANE, bone levers	114
LANE, tissue forceps	35
LANE, towel clamps	40
LANGE-HOHMANN, bone levers	114
LANGENBACK, bone levers	113
LANGENBECK, with triangle handle	56
LANGENBECK, flap knife	10
LARYNGEAL MIRRORS	06
LAWRENCE, ligature forceps	45
LEBSCHKE, rib shears	108
LEGUEU, bladder retractors	84
LEKSELL-STILLE, bone rongeurs	124
LERICHE, intestinal spatula	65
LEWIS, bone file	116
LISTER, bandage scissor	28
LISTER, cloth scissor	28
LISTER, sponge forceps	37
LISTON, bone cutting forceps	125
LOCKHART-MUMMERY, probes	52
M	
LOCKLIN, delicate scissor	23
LOPEZ-REINKE, suction instruments	129
LOWER, gall duct forceps	79
LOWMAN, bone clamps	122
LOWMAN-GERSTER, bone clamps	122
LOWMAN-HOGLUND, bone clamps	122
LUCAS, gouges	119
LUER-KORTE, gall stone scoops	80
LURE, bone rongeurs	123
M	
MAGILL, laryngoscope	07
MALTZ, rasps	116
MANNERFELT, osteotomes	119
MANNERFELT, retractors	56
MARTIN, uterine probes	92
MARTINI, bone curettes	117
MASING, retractors	57
MASSON, needle holder	49
MASSON-LUETHY, needle holder	49
MATHIEU, retractors	58
MAYO, dissecting scissors	21
MAYO, uterine probes	92
MAYO-HARRINGTON, dissecting scissors	21
MAYO-NOBLE, dissecting scissors	21
MAYO-STILLE, dissecting scissors	21
MC INDOE, forceps	32
MC KENTY, raspatories	115
MEAD, mallets	118
MICHEL, laryngeal mirrors	06
MICRO SCISSORS, laterally angled	15
MICRO-ADSON, forceps	31
MICRO-ADSON, forceps	34
MIDDELDORPF, retractors	60
MIKULICZ, tissue forceps	44
MIKULICZ, intestinal spatula	65
MIKULICZ, retractors	63
MILLER, laryngoscope	08
MILLIN, bladder retractors	84
MIXTER, ligature forceps	45
MOD.USA, plaster spreader	127
MORRIS, anastomosis clamps	74
MOYNIHAN, haemostatic forceps	44
MOYO-HEGAR, needle holder	49
MULLER LIGATURE FORCEPS	41
MULLER VESSEL CLIPS	41
MULLER, dura and skin retractor	55
MURPHY, head band	03
MUSEUX, tissue grasping forceps	39
N	
NASAL SCISSORS	23
NAUJOKS wire scissors	27
NEEDLE HOLDER, for micro surgery	48
NEGUS, tonsil forceps	44

Alphabetical Index

N			
NELATON, probes	52	ROUX, retractors	58
NELSON, lung dissecting forceps	35	RUDD, haemorrhoidal ligator	78
NISSSEN, gall duct forceps	79	RUMEL, dissecting forceps	45
NOTO, ovum forceps	94	RUSS-MODELL, tissue forceps	35
NOTO, sponge holding forceps	38	ROHRSCHEIDER, needle holder	48
NOVAK-SCHOECKAERT, biopsy curettes	95	ROLLET, dura and skin retractor	55
NOYES, micro spring scissor	13	ROSER KONIG, mouth gag	05
O			
OLIVECRONA, dura scissors	22		
OLIVECRONA, trigeminal knife	11		
P			
PARTSCH, raspatories	115	SAENGER, ovum forceps	100
PARTSCH, gouges	119	SAMII, tumor grasping forceps	30
PARTSCH, raspatories	115	SATINSKY, vena cava scissors	22
PAYR, pylorus clamps	73	SAUPE, cilia forceps	36
PEAN, haemostatic forceps	44	SCALPEL HANDLES	12
PEAN, haemostatic forceps	43	SCHAAF, cilia forceps	36
PEAN, kidney clamps	82	SCHAEDEL, towel clamps	40
PEDERSON, vaginal specula	87	SCHEINMANN, biopsy forceps	97
PEET, splinter forceps	36	SCHIMMELBUSCH, ether mask	05
PELKMANN, uterine dressing forceps	93	SCHMID, vascular spatulas	102
PERKINS, self retaining retractors	66	SCHOEMAKER-LOTH, needle holder	50
PIERCE, trocars	85	SCHOENBORN, retractors	57
PINARD, wooden stethoscope	02	SCHRODER, uterine scoops	98
PLESTER, retractors	66	SCHUMACHER, rib shears	108
PLESTER, suction instruments	129	SCHUMACHER, umbilical scissors	26
POOL, suction instruments	128	SCHUMASHER, biopsy forceps	96
POTTS-SMITH, cardiovascular scissor	22	SCOVILLE-RICHTER, retractors	67
PROBES	53	SEGOND, myomatome	11
		SEIDL, vaginal specula	87
		SEIDL-DBP, biopsy forceps	96
		SELLORS, rib spreaders	110
		SEMKEN, dissecting forceps	32
		SEMKEN, tissue forceps	34
		SEUTIN, plaster scissor	29
		SIMON, uterine scoops	98
		SIMPLEX, tongue depressor	04
		SIMPSON, uterine probes	92
		SIMPSON-BRAUN, obstetrics forceps	99
		SIMS, gynaecology scissors	25
		SIMS, vaginal specula	87
		SIMS, rectal specula	75
		SIMS, uterine probes	92
		SMOOTH JAWS FORCEPS	32
		ST.MARTIN, tissue forceps	34
		STEMBERG, tongue depressor	04
		STIEGLITZ, splinter forceps	36
		STILLE, bone rongeurs	124
		STILLE-AESFULAP, plaster shears	126
		STILLE-RUSKIN, bone rongeurs	124
		STRACK, wire scissor	27
		STRASSBURGER Tissue forceps	35
		STRULLY, cardiovascular scissors (pointed)	22
		SUCTION INSTRUMENTS	128
		SURGICAL SCISSORS, incision	19
		SURGICAL SCISSORS, serrated	18
		SURGICAL SCISSORS, slender type	18
		SURGICAL SCISSORS, standard	18
		SURGICAL SCISSORS, standard	18
		SUTURING INSTRUMENT SET	54
		SYSTRUNK, nail splitting scissors	19
Q			
QUERVAIN, bone levers	113		
R			
RABINER, neurological hammer	01		
RANDALL, biopsy curettes	95		
RANDALL, kidney stone forceps	83		
RECAMIER, uterine scoops	98		
REYNOLDS, dissecting scissors	20		
RICHTER, vaginal retractors	90		
ROCHESTER-CARMALT, haemostatic forceps	44		
ROEDER, towel clamps	40		

Alphabetical Index

T		Y	
TAKAHASHI, rongeur	112	YASARGIL, needle holder	48
TAYLOR, percussion hammer	01	YASARGIL, tumor grasping forceps	30
THOREK, cardiovascular scissors	22	YASARGIL-SAMII, tumor grasping forceps	30
THORPE, corneal forceps	31	YASRGIL, micro scissors	15
TOBOLD, tongue depressors	04	YEOMAN, biopsy forceps	77
TOENNIS ADSON, dissecting scissors	20	YOUNG, tongue forceps	05
TOENNIS, dissecting scissors	20		
TOENNIS, fine wound retractor	55		
TOENNIS, vascular spatulas	102		
TOENNIS, needle holder	50		
TRELAT, raspatories	115		
TRIGEMINAL KNIFE	11	Z	
TROCARS	85	ZENKER, ligature	45
TROEMNER, percussion hammer	01	ZENKER, retractors	62
TROUSSEAU, tracheal dilators	101	ZIEGLER, head band	03
TUFFIER, rib spreaders	109	ZIEGLER, head mirror	03
TUTTLE, lung dissecting forceps	35		
U			
UMBILICAL CORD SCISSORS	26		
UNIVERSAL BANDAGE SCISSORS	28		
UNIVERSAL TROCARS	85		
US-ARMY, retractors	58		
V			
VANNAS, micro spring scissors	13		
VOLKMANN, bone curettes	117		
VOLKMANN, bone retractors	59		
W			
WANGENSTEEN, needle holder	49		
WARTENMERG, pinwheel	01		
WEBER, anastomosis clamps	106		
WECKER, eye scissors	13		
WEIL-BLAKESLEY, rongeurs	112		
WEITLANER, self retaining retractors	66		
WERTHEIM, gynaecology scissors	25		
WERTHEIM, clamps and forceps	46		
WERTHEIM-CULLEN, vaginal clamps	47		
WIEDER, tongue depressor	04		
WILLIGER, bone curettes	117		
WILLIGER, elevators	113		
WILLIGER, raspatories	115		
WINTER, ovum forceps	100		
WOLFF, plaster breakers	127		
WULLSTEIN, retractors	66		